

CEMUX

Gollinucci



HAUSSMANN



INTERIORES PARA ARMÁRIOS

CASATREND | DIVERSOS



Canto Swing SE

CEMUX

Capacidade máxima de 20 kg por tabuleiro.

Módulo

Largura	mín. 900 mm
Profundidade	mín. 540 mm
Altura	mín. 500 mm

Porta	Acab.	Montagem	
		Esquerda	Direita
40	Antracite	SCS02800GL	SCS02800GR
45	Antracite	SCS02900GL	SCS02900GR
50	Antracite	SCS02100GL	SCS02100GR
60	Antracite	SCS02120GL	SCS02120GR
40	Cromado	SCS12800WL	SCS12900WR
45	Cromado	SCS12900WL	SCS12900WR
50	Cromado	SCS12100WL	SCS12120WR
60	Cromado	SCS12120WL	SCS12120WR

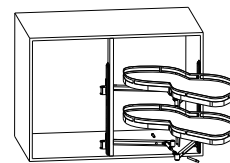

Montagem Direita

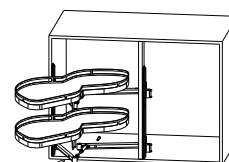

Montagem Esquerda

Porta-Garrafas SE

CEMUX

Soft-close.
Capacidade de 15 kg.
Ajuste 3D.

Módulo

Profundidade	mín. 500 mm
Altura	mín. 500 mm



Módulo	L (mm)	P (mm)	A (mm)	Acab.	Montagem	
					Esquerda	Direita
15	101	471	486	Antracite	SBP13150GL	SBP13150GR
20	137	471	486	Antracite	SBP13200GL	SBP13200GR
15	101	471	486	Cromado	SBP13150WL	SBP13150WR
20	137	471	486	Cromado	SBP13200WL	SBP13200WR

Armário SE

CEMUX

Soft-close.
Capacidade de 20 kg.
Ajuste 3D.

Módulo

Profundidade	mín. 500 mm
Altura	mín. 500 mm

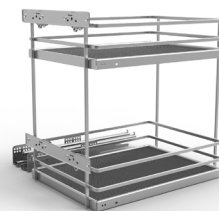

Módulo	L (mm)	P (mm)	A (mm)	Acab.	Código
30	264	471	486	Antracite	SBP13300G
40	364	471	486	Antracite	SBP13400G
50	464	471	486	Antracite	SBP13500G
30	234	471	486	Cromado	SBP13300W
40	364	471	486	Cromado	SBP13400W
50	464	471	486	Cromado	SBP13500W



Porta-Garrafas 70 Neo System

Corrediças sincronizadas de extração total com soft-close.
Corrediças montadas na ilharga esquerda.
Tapete antiderrapante e separadores incluídos.

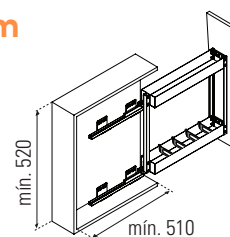

Módulo	L (mm)	P (mm)	A (mm)	Cestos	Acab.	Código
15	100	510	520	2	Antracite	PG.NEO.70.15
20	150	510	520	2	Antracite	PG.NEO.70.20
25	200	510	520	2	Antracite	PG.NEO.70.25

Cap. por cesto 10 kg
Ilharga 16 ou 19 mm

Armário 70 Neo System

Corrediças sincronizadas de extração total com soft-close.
Corrediças montadas em lados opostos da ilharga.
Tapete antiderrapante e separadores incluídos.

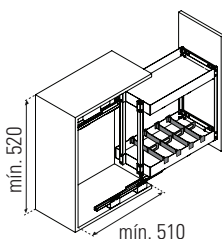

Módulo	L (mm)	P (mm)	A (mm)	Cestos	Acab.	Código
30	250	510	520	2	Antracite	PG.NEO.70.30
35	300	510	520	2	Antracite	PG.NEO.70.35
40	350	510	520	2	Antracite	PG.NEO.70.40



> Montagem das corrediças

Cap. por cesto 10 kg
Ilharga 16 ou 19 mm



Porta-Garrafas 80 Neo System

Corrediças sincronizadas de extração total com soft-close.
Corrediças montadas na ilharga esquerda.
Tapete antiderrapante e separadores incluídos.

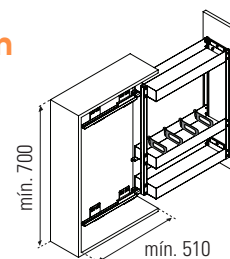

Módulo	L (mm)	P (mm)	A (mm)	Cestos	Acab.	Código
15	100	510	700	3	Antracite	PG.NEO.80.15
20	150	510	700	3	Antracite	PG.NEO.80.20
25	200	510	700	3	Antracite	PG.NEO.80.25

Cap. por cesto 10 kg
Ilharga 16 ou 19 mm



Armário 80 Neo System

Corrediças sincronizadas de extração total com soft-close.
Corrediças montadas em lados opostos da ilharga.
Tapete antiderrapante e separadores incluídos.

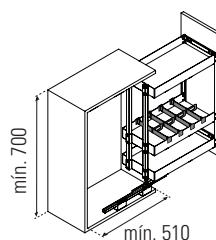

Módulo	L (mm)	P (mm)	A (mm)	Cestos	Acab.	Código
30	250	510	700	3	Antracite	PG.NEO.80.30
35	300	510	700	3	Antracite	PG.NEO.80.35
40	350	510	700	3	Antracite	PG.NEO.80.40

Cap. por cesto	10 kg
Ilharga	16 ou 19 mm



> Montagem das corrediças

Cesto Giratório 270° Neo System

Tapete antiderrapante incluído.

Módulo	D (mm)	A (mm)	Acab.	Código
80	700	700-800	Antracite	C.270.NEO.700
90	815	700-800	Antracite	C.270.NEO.810

Cap. por cesto	10 kg
Ilharga	16 ou 19 mm

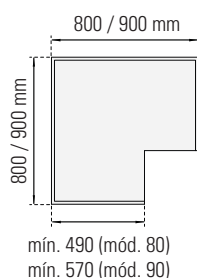
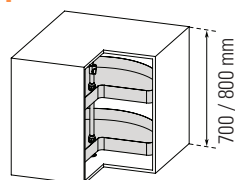
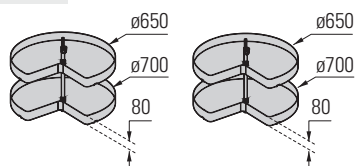

Canto Swing Neo System

Soft-close.
Tapete antiderrapante incluído.

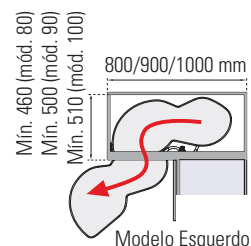

Módulo	A (mm)	Porta	Acab.	Esquerda	Direita
80	700-800	40	Antracite	C.SWING.NEO.40.E	C.SWING.NEO.40.D
90	700-800	45	Antracite	C.SWING.NEO.45.E	C.SWING.NEO.45.D
100	700-800	60	Antracite	C.SWING.NEO.60.E	C.SWING.NEO.60.D

Cap. por cesto	15 kg
Ilharga	16 ou 19 mm

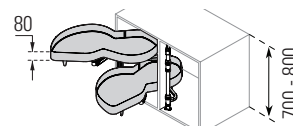

Modelo esquerdo

Canto Mágico Universal Neo System

Soft-close.

Tapete antiderrapante incluído.

Módulo	Porta	Acab.	Código
80	40	Antracite	C.UNIV.NEO.40
90	45	Antracite	C.UNIV.NEO.45

Cap. por cesto	8 kg
Ilharga	16 ou 19 mm

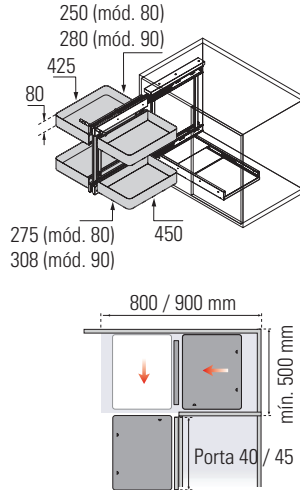

Modelo esquerdo

Canto de Porta Neo System

Tapete antiderrapante incluído.

Módulo	Porta	Acab.	Montagem	
			Esquerda	Direita
90	40	Antracite	C.PORTA.NEO.40.E	C.PORTA.NEO.40.D

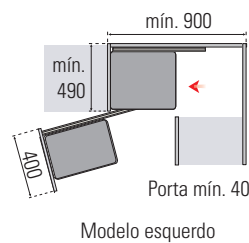

Modelo esquerdo

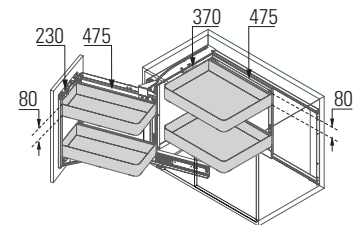

Canto Mágico Pro Neo System

Soft-close.

Tapete antiderrapante incluído.

Módulo	Porta	Acab.	Montagem	
			Esquerda	Direita
90	45	Antracite	C.PRO.NEO.45.E	C.PRO.NEO.45.D
100	60	Antracite	C.PRO.NEO.60.E	C.PRO.NEO.60.D

Cap. por cesto	8 kg
Ilharga	16 ou 19 mm

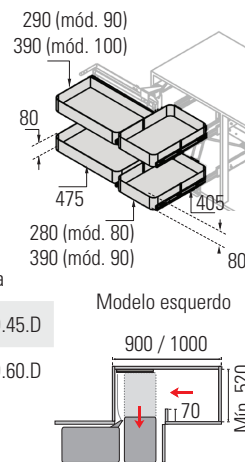

Modelo esquerdo



Modelo esquerdo

Despenseiro Neo System

Soft-close.

Tapete antiderrapante incluído.

Módulo	L (mm) do cesto	Acab.	Altura (mm)	
			1250-1570	1850-2170
30	255	Antracite	DESP.NEO.B.30	DESP.NEO.A.30
35	305	Antracite	DESP.NEO.B.35	DESP.NEO.A.35
40	355	Antracite	DESP.NEO.B.40	DESP.NEO.A.40
45	405	Antracite	DESP.NEO.B.45	DESP.NEO.A.45
50	455	Antracite	DESP.NEO.B.50	DESP.NEO.A.50
60	505	Antracite	DESP.NEO.B.60	DESP.NEO.A.60

Cap. por cesto	10 kg
Ilharga	16 ou 19 mm

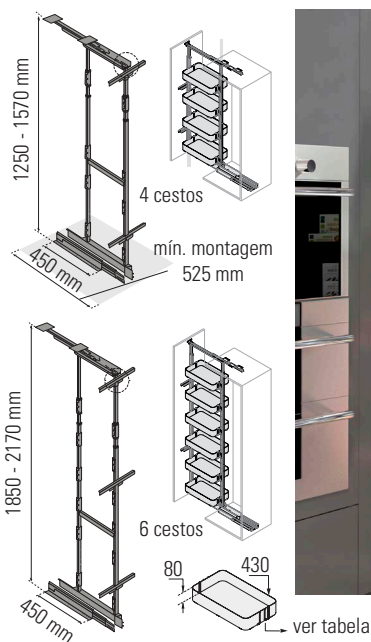

Armário Extraível Movix Pro

GTV

Extração total com amortecedor.

Tubo retangular antracite e fundo metálico.

Tapete de borracha antiderrapante antracite.

Nos modelos de 15 e 20, inclui uma corredeira a ser instalada à direita ou à esquerda.

Nos modelos de 30 e acima, inclui duas corredeiras a serem instaladas cruzadamente.

Módulo	P (mm)	A (mm)	Acabamento	
			Antracite	Cromado
15	471	486	KO-150BO-60	KO-150BO-01
20	471	486	KO-200BO-60	KO-200BO-01
30	471	486	KO-300BO-60	KO-300BO-01
40	471	486	KO-400BO-60	KO-400BO-01
50	471	486	KO-500BO-60	KO-500BO-01



Canto Mágico Movix Pro

GTV

Sistema soft-close.

Modelo reversível.

Possibilidade de abertura manual, ou fixação à porta.

Profundidade mínima do módulo de 540 mm.

Capacidade de 7 kg nos cestos interiores e de 5 kg nos exteriores.

Módulo	P (mm)	A (mm)	Acabamento	
			Antracite	Cromado
45	519	737	KO-WMC450-60	KO-WMC450-01





Canto de Porta Movix Prov **GTV**

Sistema soft-close.
Com fundo antiderrapante antracite.
Modelo reversível.
Profundidade mínima do módulo de 530 mm.
Capacidade de 8 kg em cada cesto.



Módulo	P (mm)	A (mm)	Acabamento	
			Antracite	Cromado
45	526	516	KO-UMC450-60	KO-UMC450-01

Porta-Garrafas de 15 e 20

Soft-close.

Módulo	L (mm)	P (mm)	A (mm)	Código
15	100	450	535	POBSC150
20	150	450	535	POBSC200

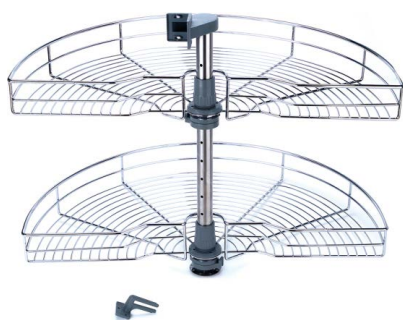

Cesto de 270°

Módulo	D (mm)	P (mm)	A (mm)	Código
80	710	565	790	C270.710
90	800	565	790	C270.800



Cesto de 180°

Módulo	Porta	D (mm)	A (mm)	Código
75	40	680	565	C180.680
80	45	745	565	C180.745
90	50	850	—	C180.845



Porta Garrafas Deluxe com Cesto de Pão Opcional

Versátil: vem com prateleira removível para aplicação do cesto de pão (incluído).

Corrediças de extração total, montadas em lados opostos da ilharga.

Soft-close.

Dimensões mínimas do módulo: 505 P x 585 A (mm).

Opcionalmente, pode ser incluído um mecanismo push-to-open.

Módulo	L (mm)	P (mm)	A (mm)	Cap. (kg)	Acabamento	
					Cromado	Antracite
15	100	480	535	30	PG.D.15C	PG.D.15A
20	140	480	535	30	PG.D.20C	PG.D.20A
25	190	480	535	30	PG.D.25C	PG.D.25A
30	235	480	535	30	PG.D.30C	PG.D.30A
35	285	480	535	30	PG.D.35C	PG.D.35A
40	335	480	535	30	PG.D.40C	PG.D.40A

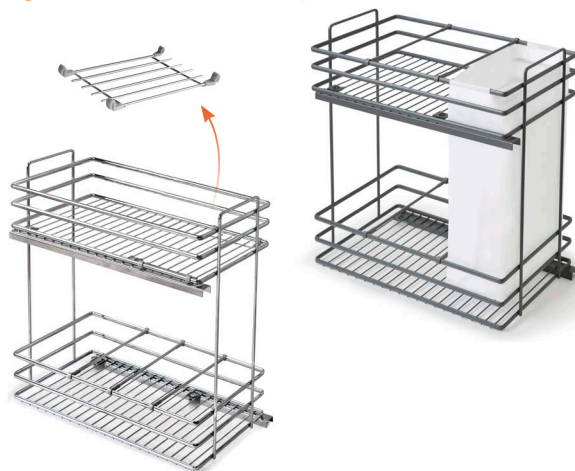

Códigos das versões sem push-to-open. Para obter os códigos das versões com push-to-open, adicionar "P" no final do código. Por exemplo, PG.D.15CP.

Set 2 Bases

	Mód. 15	Mód. 20	Mód. 25	Mód. 30	Mód. 35	Mód. 40
Cinza	PG.D.15BC	PG.D.20BC	PG.D.25BC	PG.D.30BC	PG.D.35BC	PG.D.40BC
Antracite	PG.D.15BA	PG.D.20BA	PG.D.25BA	PG.D.30BA	PG.D.35BA	PG.D.40BA



Armário Porta Garrafas Universal

Corrediças de extração total, montadas em lados opostos da ilharga.

Soft-close.

Dimensões mínimas do módulo: 505 P x 525 A (mm).

Módulo	L (mm)	P (mm)	A (mm)	Cap. (kg)	Código
15	100	470	475	30	PG.U.15
20	140	470	475	30	PG.U.20
30	230	470	475	30	PG.U.30
35	280	470	475	30	PG.U.35
40	330	470	475	30	PG.U.40

Set 2 Bases

Em cinza.

Módulo	Código
15	PG.U.15BC
20	PG.U.20BC
30	PG.U.30BC
35	PG.U.35BC
40	PG.U.40BC



Gaveta Cromada

Corrediças de extração total.

Soft-close.

Profundidade mínima do módulo: 510mm.

M	P (mm)	A (mm)	Cap. (kg)	Código
30	450	125	20	GC.30
35	450	125	20	GC.35
40	450	125	20	GC.40
45	450	125	20	GC.45
50	450	125	20	GC.50
60	450	125	20	GC.60
70	450	125	20	GC.70
80	450	125	20	GC.80
90	450	125	20	GC.90
100	450	125	20	GC.100

Set 2 Bases

Em cinza.

M	Código
30	GC.30BC
35	GC.35BC
40	GC.40BC
45	GC.45BC
50	GC.50BC
60	GC.60BC
70	GC.70BC
80	GC.80BC
90	GC.90BC
100	GC.100BC

Porta Garrafas Tubo Oval

Soft-close.

No acabamento cromado, o fundo das prateleiras é branco.

M	L (mm)	Acabamento	
		Comado	Antracite
15	150	PGTO.15.C	PGTO.15.A
20	200	PGTO.20.C	PGTO.20.A
30	300	PGTO.30.C	PGTO.30.A



Gaveta Tubo Oval

Soft-close.

No acabamento cromado, o fundo das prateleiras é branco.



M	L (mm)	Acabamento	
		Comado	Antracite
35	350	GTO.35.C	GTO.35.A
40	400	GTO.40.C	GTO.40.A
45	450	GTO.45.C	GTO.45.A
50	500	GTO.50.C	GTO.50.A
60	600	GTO.60.C	GTO.60.A



Cesto 180º Tubo Oval

No acabamento cromado, o fundo das prateleiras é branco.

D (mm)	Acabamento	
	Comado	Antracite
750	C180TO.C	C180TO.A

Canto Mágico Bean Tubo Oval

Soft-close.

Módulo	Porta	Acab.	Montagem	
			Esquerdo	Direito
80	40	Cromado e branco	CBEANTO.80.E.CB	CBEANTO.80.D.CB
80	40	Cromado e cinza	CBEANTO.80.E.CC	CBEANTO.80.D.CC
80	40	Antracite	CBEANTO.80.E.ANT	CBEANTO.80.D.ANT
90	45	Cromado e branco	CBEANTO.90.E.CB	CBEANTO.90.D.CB
90	45	Cromado e cinza	CBEANTO.90.E.CC	CBEANTO.90.D.CC
90	45	Antracite	CBEANTO.90.E.ANT	CBEANTO.90.D.ANT

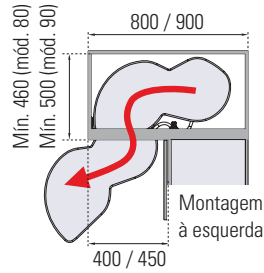

Canto Mágico Tubo Oval

Soft-close.

No acabamento cromado, o fundo das prateleiras é branco.

Acab.	Montagem	
	Esquerdo	Direito
Cromado	CMTO.E.C	CMTO.D.C
Antracite	CMTO.E.A	CMTO.D.A

Canto Mágico Universal Tubo Oval

De aplicação universal – pode ser aplicado em ambos os lados.
Soft-close.

Cestos de dimensão: L 270 x P 430 x A 80 mm.

Módulo	Porta	P (mm)	Acab.	Código
80	40 / 45	520	Cromado e branco	CMUTO.C
80	40 / 45	520	Antracite	CMUTO.A

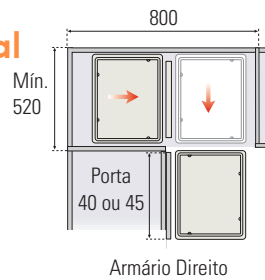

Despenseiro Tubo Oval

Soft-close.

Cap. por cesto 7,5 kg
Ilharga 16 ou 19 mm

Módulo	L (mm) do cesto	Acab.	Altura (mm)		
			1250-1570	1550-1870	1850-2170
30	240	Cromado e branco	DESPTO.B.30.CB	DESPTO.M.30.CB	DESPTO.A.30.CB
35	290	Cromado e branco	DESPTO.B.35.CB	DESPTO.M.35.CB	DESPTO.A.35.CB
40	340	Cromado e branco	DESPTO.B.40.CB	DESPTO.M.40.CB	DESPTO.A.40.CB
45	390	Cromado e branco	DESPTO.B.45.CB	DESPTO.M.45.CB	DESPTO.A.45.CB
50	440	Cromado e branco	DESPTO.B.50.CB	DESPTO.M.50.CB	DESPTO.A.50.CB
60	540	Cromado e branco	DESPTO.B.60.CB	DESPTO.M.60.CB	DESPTO.A.60.CB
30	240	Antracite	DESPTO.B.30.ANT	DESPTO.M.30.ANT	DESPTO.A.30.ANT
35	290	Antracite	DESPTO.B.35.ANT	DESPTO.M.35.ANT	DESPTO.A.35.ANT
40	340	Antracite	DESPTO.B.40.ANT	DESPTO.M.40.ANT	DESPTO.A.40.ANT
45	390	Antracite	DESPTO.B.45.ANT	DESPTO.M.45.ANT	DESPTO.A.45.ANT
50	440	Antracite	DESPTO.B.50.ANT	DESPTO.M.50.ANT	DESPTO.A.50.ANT
60	540	Antracite	DESPTO.B.60.ANT	DESPTO.M.60.ANT	DESPTO.A.60.ANT

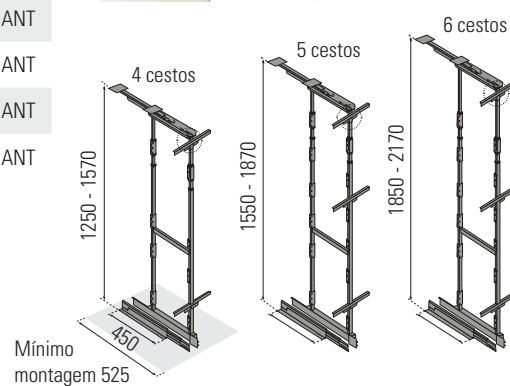

Barra Extensível



Regulação da frente

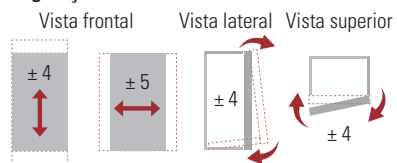

Cantos Mágico Universal Trend 1000

De aplicação universal – pode ser aplicado em ambos os lados.

Soft-close.

Dimensões mínimas do módulo: 570 P x 690 A (mm).

Módulo	Código
80	CMU5000

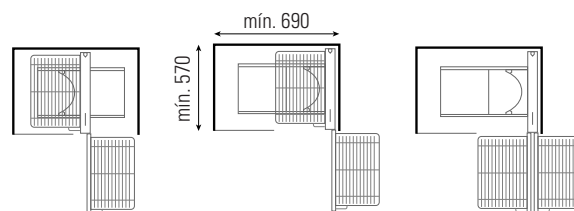

Gaveta Cromada Módulo Lava-Louça

Corrediças de extração total.

Soft-close.

Dimensões mínimas do módulo: 525 P x 180 A (mm).

Módulo	P (mm)	A (mm)	Cap. (kg)	Código
60	490	80	15	GC.LL.60
80	490	80	15	GC.LL.80
90	490	80	15	GC.LL.90



Jogo de Recipientes Plásticos

Mód. 60	Mód. 80	Mód. 90
GC.LL.60RP	GC.LL.80RP	GC.LL.90RP



Acessório Módulo Lava-Louça Free Form

elleppi
1 5 4

Para gaveta blum.
Recipientes em alumínio.



Mód. 60

Mód. 80 e 90

Mód. 100 e 120

Módulo	L (mm)	P (mm)	A (mm)	Código
60	514	474	75	FREEFORM60
80	714	474	75	FREEFORM80
90	814	474	75	FREEFORM90
100	914	474	75	FREEFORM100
120	1114	474	75	FREEFORM120

Acessório Módulo Lava-Louça 720A

Módulo	L (mm)	P (mm)	A (mm)	Blum Legrabox	Para gaveta Blum Tandembox	Grass Nova Pro
60	560 - 568	505	80	720A.BL.60	720A.BT.60	720A.GNP.60
80	760 - 768	505	80	720A.BL.80	720A.BL.80	720A.GNP.80
90	860 - 868	505	80	720A.BL.90	720A.BL.90	720A.GNP.90
100	960 - 968	505	80	720A.BL.100	720A.BT.100	720A.GNP.100
120	1160 - 1168	505	80	720A.BL.120	720A.BT.120	720A.GNP.120

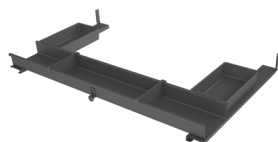



Acessório Módulo Lava-Louça 955

Gollinucci

Prateleiras extraíveis.
Em alumínio.

Módulo	Recipientes	Para gaveta		
		Blum Legrabox	Blum Tandembox	Grass Nova Pro
60	2	955.BL.60	955.BT.60	955.GNP.60
70	2	955.BL.70	955.BT.70	955.GNP.70
75	2	955.BL.75	955.BT.75	955.GNP.75
80	3	955.BL.80	955.BT.80	955.GNP.80
90	3	955.BL.90	955.BT.90	955.GNP.90
100	3	955.BL.100	955.BT.100	955.GNP.100
120	4	955.BL.120	955.BT.120	955.GNP.120

Escorredor Pratos Inox

Profundidade mínima do módulo: 270 mm.
Montagem em ilharga de 16 ou 19 mm.

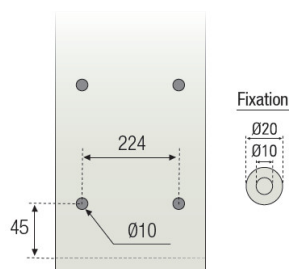

Módulo	Código
40	EP.40I
45	EP.45I
50	EP.50I
60	EP.60I
70	EP.70I
80	EP.80I
90	EP.90I
100	EP.100I



Prateleira Aramada

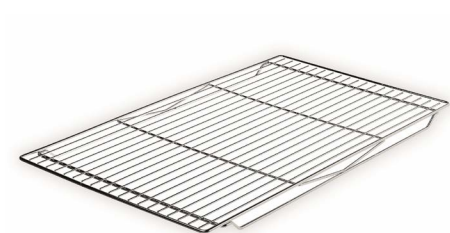

Módulo	L (mm)	A (mm)	Profundidade (mm)	
			260	480
45	408	30	PA.260.M45	—
60	558	30	PA.260.M60	PA.480.M60
90	858	30	PA.260.M90	PA.480.M90
120	1158	30	PA.260.M120	PA.480.M120
180	1758	30	PA.260.M180	PA.480.M180

Kit de Suportes

Kit de 4 suportes.
Parafusos Euro de Ø 5 mm incluídos.



L (mm)	P (mm)	A (mm)	Código
13	16	23	PA.J4S



Despenseiro 4 Prateleiras

L (mm)	P (mm)	A (mm)	Acab.	Código
350	240	900	Cromado	DESP4P.C

Porta-Detergentes na Porta

L (mm)	P (mm)	A (mm)	Acab.	Código
355	105	415	Cromado	PDP2P.C



Suporte de Tubo de Aspirador com Prateleiras

L (mm)	P (mm)	A (mm)	Código
380	90	760	STAP.C



Suporte de Tubo de Aspirador Simples

STAS.C

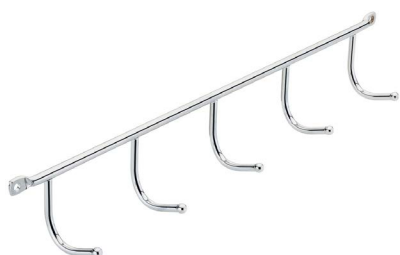

Suporte com 5 Ganchos para Parede

Em aço.

L (mm)	P (mm)	A (mm)	Código
350	43	49	SP5G.C



Organizador Interior de Porta ABS

Em ABS.

L (mm)	P (mm)	A (mm)	Acab.	Código
260	102	68	Transparente	OIP.P.PT
520	102	68	Transparente	OIP.G.PT
260	102	68	Branco	OIP.P.B
520	102	68	Branco	OIP.G.B

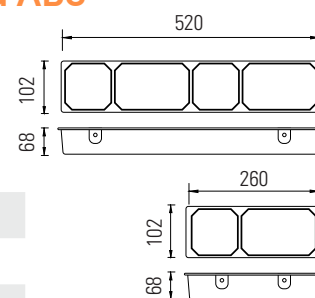

Suporte Cromado para Copos

L (mm)	P (mm)	A (mm)	Acab.	Código
110	320	64	Cromado	SC1.C



Pantry Box



- Caixa plástica estável e fácil de limpar.
- Grade de plástico removível com ranhuras de drenagem e ventilação.
- Tampa deslizante de vidro para armazenamento coberto de alimentos.
- Grelhas de madeira para pão e de plástico para legumes e fruta.
- Contentor de plástico transportável com pega.

Cabe em qualquer gaveta de 60 da Blum, Grass; Herrich de profundidade nominal 500 mm. Ajustável a ilharga de 16-19 mm.

Módulo	L (mm)	P (mm)	A (mm)	Acab.	Código
60	562-568	491	232	Branco	H.3960601

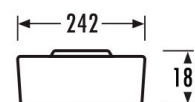

Vario Single



Porta-esponjas.

Módulo	L (mm)	P (mm)	A (mm)	Acabamento		Código
				Parte metálica	Parte plástica	
20	155	480	173	Alumínio	Cinza	H.3920001



Vario



Porta-tabuleiros com ganchos.

Módulo	L (mm)	P (mm)	A (mm)	Acabamento		Código
				Parte metálica	Parte plástica	
20	158	483	481	Alumínio	Cinza	H.3902001



Carry



Porta-detergentes.

Dois cestos transportáveis, anexáveis a bandeja de correr.

L (mm)	P (mm)	A (mm)	Código
245	459	395	H.3950001

Porta-Detergentes LAB1150

Gollinucci

Inclui um tabuleiro multi-usos removível.

Módulo 40 se usada a funcionalidade de extração automática. Caso se opte por extração manual, o armário pode ser de módulo 35.

Módulo	L (mm)	P (mm)	A (mm)	Acab.	Código
35 / 40	267	440	291	Branco	PD.LAB1150



Suporte para Vassouras

Vassouras com espessura de 23-28mm.

Suporte de aço e roldanas de borracha.

L (mm)	P (mm)	A (mm)	Código
51	40	50	SV1



Suporte de Vassouras



Para aplicar na ilharga lateral.
Estrutura metálica lacada a branco.
Instalação fácil com apenas 4 parafusos.

L (mm)	P (mm)	A (mm)	Acab.	Código
137	352	262	Lacado branco	H.3271251
137	352	262	Lacado antracite	H.3271821

Suporte para Tábua de Engomar ou Escada

Suporte prático para segurar verticalmente objetos.
Em metal pintado.



L (mm)	P (mm)	A (mm)	Acab.	Código
155	350	50	Branco	H.3272161
155	350	50	Antracite	H.3272181



Prateleira com Escova e Apanhador



Inclui escova e apanhador.

L (mm)	P (mm)	A (mm)	Acab.	Código
289	480	158	Branco	H.3271151
289	480	158	Antracite	H.3271811

Suporte com 2 Cestos



L (mm)	P (mm)	A (mm)	Acab.	Código
436	198	241	Azul	H.3271501
436	198	241	Branco	H.3271841

Estendal de Roupa

Rebatível.



L (mm)



P (mm)



A (mm)



Acab.

Código

525

820

300

Branco

H.3271901



Toalheiro Secco de 2/3 barras



A fixação do componente de suporte das barras elípticas é variável, pelo que o produto pode ser ajustado, durante a instalação, ao conforto do cliente.

Barras	L (mm)	P (mm)	A (mm)	Acabamento		Código
				Parte metálica	Parte plástica	
2	122	457	30	Alumínio	Cinza	H.3132101
3	184	457	30	Alumínio	Cinza	H.3133101

Toalheiro de Alumínio

Aplicação na horizontal ou na vertical.

Barras	P (mm)	A (mm)	Código
1	465	71	TA1
2	465	95	TA2
3	465	140	TA3

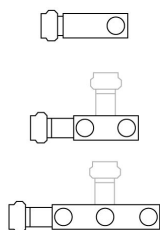

Porta Detergentes

L (mm)	P (mm)	Altura	Código
173	465	Baixo	PD.B
173	465	Alto	PD.A

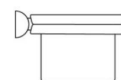



Stepfix



Escadote compactável.
Dois degraus de L 33 x P 20 cm.
Altura de degrau (elevação): 35 cm.

Quando aberto			Quando compacto			Acab.	Código
L (mm)	P (mm)	A (mm)	L (mm)	P (mm)	A (mm)		
403	387	380	403	100	470	Antracite	H.4410001



Suporte Universal para Stepfix



Para aplicar na ilharga lateral.

L (mm)	P (mm)	A (mm)	Acab.	Código
144	37	30	Cinza escuro	H.4495001