



ILUMINAÇÃO DE CASA-DE-BANHO

CASATREND



Pandora LED

EBIR

Corpo em alumínio e ABS.
220 V.

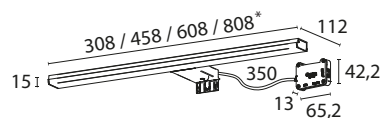

L (mm)	W	Lm	Luz	Código
308	8	880	5700 K	PANDORA308
458	10	1100	5700 K	PANDORA458
608	12	1320	5700 K	PANDORA608
808	15	1800	5700 K	PANDORA808

* Modelo de 808 mm de largura com dois suportes a 414 mm de distância.

Célia LED

EBIR

Corpo em alumínio e ABS.
220 V.

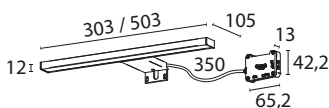

L (mm)	W	Lm	Luz	Código
303	6	660	5700 K	CELIA303
503	10	1100	5700 K	CELIA503

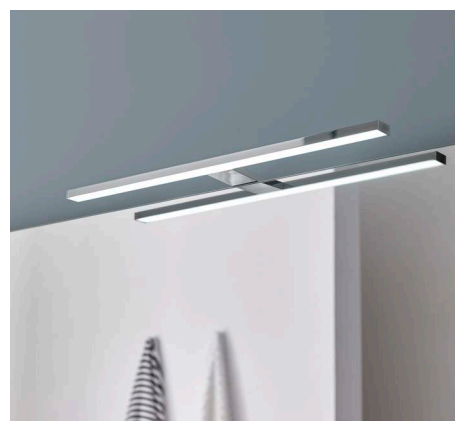

Nikita LED

EBIR

Corpo em PVC.
220 V.

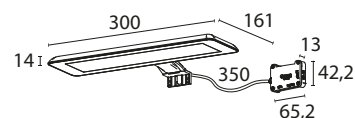

L (mm)	W	Lm	Luz	Código
300	10	1870	5700 K	NIKITA300

Verónica LED

EBIR

Corpo em ABS.
220 V.

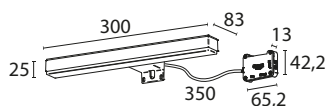

L (mm)	W	Lm	Luz	Código
300	8	525	5700 K	VERONICA300





Amber LED



Instalação em cima do espelho ou encaixado nele.
230 V.

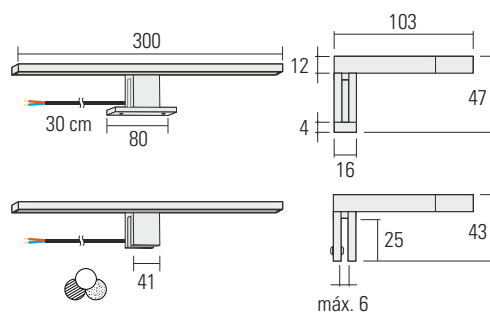

L (mm)	W	Lm	Luz	Acab.	Código
300	4,5	220	6000 K	Cromado	AMBER.C.60K
300	4,5	220	6000 K	Preto	AMBER.P.60K
300	4,5	220	6000 K	Dourado	AMBER.D.60K

Desembaciador de Espelho 400x400

Cabo de 400 mm.

L (mm)	A (mm)	W	Código
400	400	32 - 46	DE4040

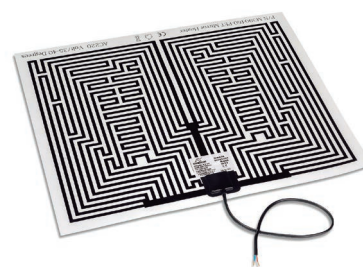

Aro de Espelho

Composto por:

- Perfil PVC de 25 x 25 mm, com 2 metros de comprimento.
- Esquadro de montagem, com rasgo para fixação à parede.

Artigo	Acab.	Código
Perfil PVC	Branco	PECB2525
Esquadro	—	EPECB2525

