

MAGIC CORNER COMFORT CORNER PULL-OUT

—
Optimal use of space in corner units



 swiss made

CONFIGURATIONS



Libell shelves
(white / silver / anthracite)



Fioro shelves, anthracite

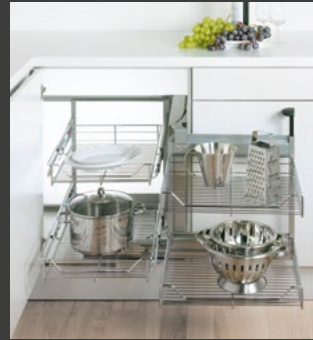

Basket Excellent, chrome

DISTINGUISHING FEATURES

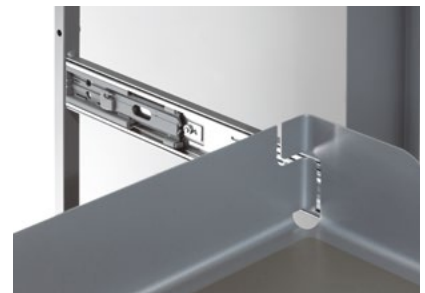

- Just open the doors and pull on the handle to make the front shelves swing right out of the unit
- The back shelves can be pulled out individually for easy loading and unloading
- The perfect solution for storing tableware, pots and pans

- Excellent access and a clear overview across the entire storage space from three sides
- Makes best use of the available space

- Integrated Softclose soft-closing mechanism
- The front shelves can easily be removed for cleaning and clipped back into place
- For hinged doors: the hinges can be on the right or the left

OPTIONS



Non-slip mat

This non-slip mat stops the unit's contents from sliding around.



Divider

Magnetic dividers are a flexible way for you to organise your shelf space.

TECHNICAL ILLUSTRATION

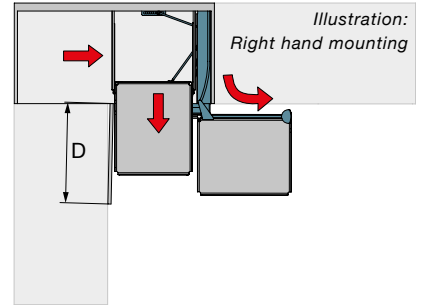
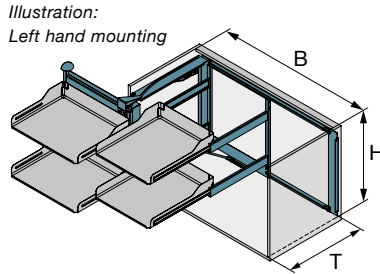
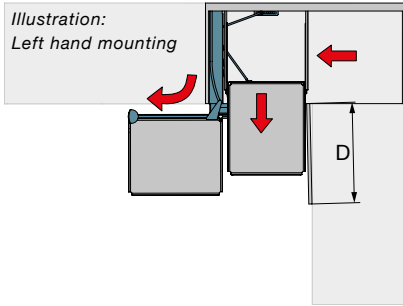

B= Interior width	862-971/962-1171 mm
T= Interior depth	500 mm
H= Interior height	545 mm

LIST OF COMPONENTS

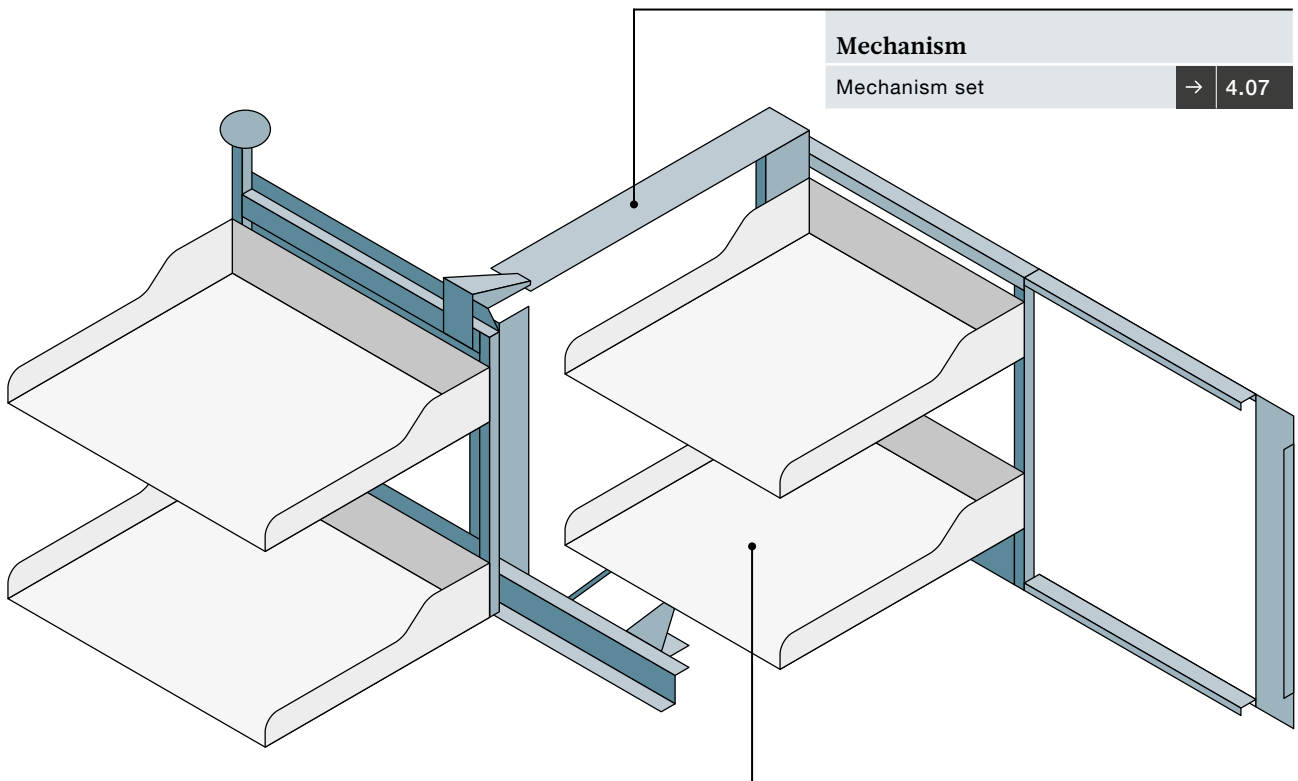

Mechanism

Mechanism set

→ 4.07

Accessories

Clip-on shelf set Libell

→ 4.08

Clip-on shelf set Fiore

→ 4.09

Clip-on basket set Excellent

→ 4.09



Magic Corner Comfort left

Complete mechanism set for hinged doors

- Back-wall shelves can be pulled out independently

Set includes:

- 1 back-wall frame
- 2 Softclose (side and back-wall frame)
- 1 pull-out frame with height-adjustable handle
- 1 swivel lever
- set of assembly material

Load capacity per clip-on component:

Front: 10 kg / Back: 8 kg

Type	Surface	Width	Depth	Height	Art. No.
900	white	862 - 971	500	545	300.0581.01
900	silver	862 - 971	500	545	300.0581.12
900	anthracite	862 - 971	500	545	300.0581.43
1000	white	962 - 1171	500	545	300.0583.01
1000	silver	962 - 1171	500	545	300.0583.12
1000	anthracite	962 - 1171	500	545	300.0583.43



Magic Corner Comfort right

Complete mechanism set for hinged doors

- Back-wall shelves can be pulled out independently

Set includes:

- 1 back-wall frame
- 2 Softclose (side and back-wall frame)
- 1 pull-out frame with height-adjustable handle
- 1 swivel lever
- set of assembly material

Load capacity per clip-on component:

Front: 10 kg / Back: 9 kg

Type	Surface	Width	Depth	Height	Art. No.
900	white	862 - 971	500	545	300.0580.01
900	silver	862 - 971	500	545	300.0580.12
900	anthracite	862 - 971	500	545	300.0580.43
1000	white	962 - 1171	500	545	300.0582.01
1000	silver	962 - 1171	500	545	300.0582.12
1000	anthracite	962 - 1171	500	545	300.0582.43



Clip-on shelf set Libell

For Magic Corner Comfort type 900/1000

Set includes:

4 clip-on shelves Libell

Cross connectors and deflection clips

Door width min.	Surface	Width	Depth	Height	Art. No.
450	white	290 / 290	470 / 470	92	300.0696.xx
500	silver	290 / 340	470 / 470	92	300.0697.xx
600	anthracite	390 / 390	470 / 470	92	300.0698.xx

Colour code .xx: 01 = white, 12 = silver, 43 = anthracite

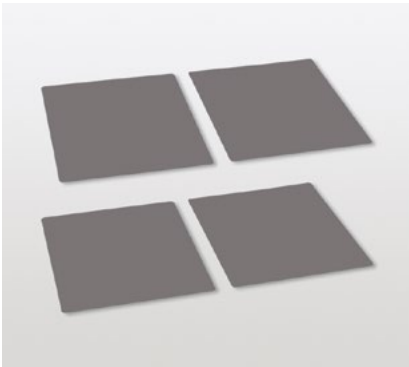

Non-slip mat set magnetic

For the clip-on shelf set Libell for Magic Corner Comfort

- Magnetic
- Easy to remove for cleaning

Set includes four mats

oyster white = for white shelves

walnut grey = for silver/anthracite shelves

Door width min.	Surface	Width	Depth	Height	Art. No.
450	oyster white walnut grey	240 / 240	425 / 425	0.5	300.0681.xx
500		240 / 290	425 / 425	0.5	300.0682.xx
600		340 / 340	425 / 425	0.5	300.0683.xx

Colour code .xx: 57 = oyster white, 56 = walnut grey

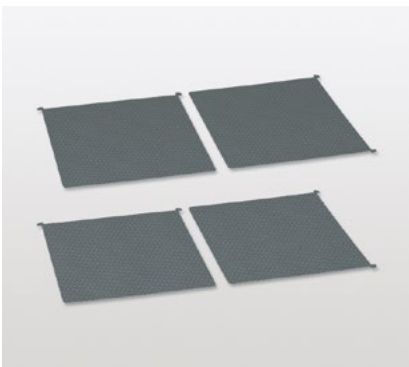

Non-slip mat set Standard Libell

For the Libell clip-on shelf set for Magic Corner Comfort

- Gummed on both sides
- Raised diamond pattern
- Easy to remove for cleaning

Set includes four mats

Door width min.	Surface	Width	Depth	Height	Art. No.
450	grey	264 / 258	438 / 447	1	300.0923.18
500	grey	264 / 308	438 / 447	1	300.0924.18
600	grey	364 / 358	438 / 447	1	300.0925.18

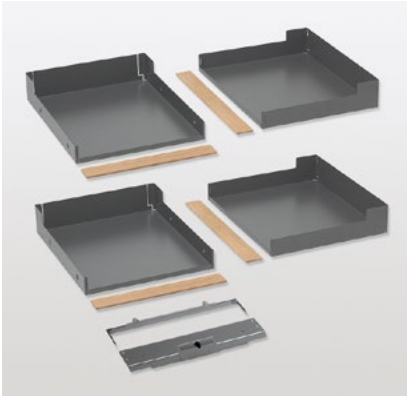

Clip-on shelf set Fiore

For Magic Corner Comfort type 900/1000

Set includes:

4 clip-on shelves Fiore

4 wooden rails oak medium (height 52 mm)

Cross connectors and deflection clips

Door width min.	Surface	Width	Depth	Height	Art. No.
450	anthracite	290 / 280	470 / 470	90	300.0972.43
500	anthracite	290 / 330	470 / 470	90	300.0973.43
600	anthracite	390 / 380	470 / 470	90	300.0974.43

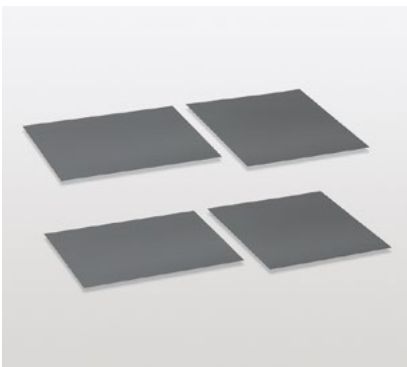

Non-slip mat set Standard Fiore

For the Fiore clip-on shelf set for Magic Corner Comfort

- Gummed surface
- Raised diamond pattern
- Easy to remove for cleaning

Set includes 4 mats

Door width min.	Surface	Width	Depth	Height	Art. No.
450	grey	283 / 270	456 / 466	1	300.0975.18
500	grey	283 / 320	456 / 466	1	300.0976.18
600	grey	383 / 370	456 / 466	1	300.0977.18



Shelf divider

Magnetic divider for Libell and Fiore shelves

- Can be attached to the shelf (base or side) or the non-slip mat

	Surface	Width	Depth	Height	Art. No.
	white	85	26 / 3	90	100.0706.51
	grey	85	26 / 3	90	100.0706.52
	anthracite	85	26 / 3	90	100.0706.43

Order quantity: 4 pieces or a multiple per article number

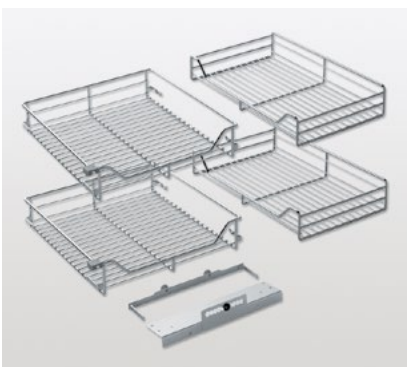

Clip-on basket set Excellent

For Magic Corner Comfort type 900/1000

Set includes:

4 Clip-on baskets Excellent

Cross connectors and deflection clips

Door width min.	Surface	Width	Depth	Height	Art. No.
450	chrome	270 / 290	470 / 470	80 / 85	300.0596.05
500	chrome	340 / 290	470 / 470	80 / 85	300.0597.05
600	chrome	390 / 390	470 / 470	80 / 85	300.0599.05