

# HOCHSCHRANK STANDARD LARDER PULL-OUT

The handy front pull-out for practical kitchens



 swiss made

## CONFIGURATIONS



Libell shelves  
(white / silver / anthracite)



Fiore shelves, anthracite



Basket Excellent, chrome



Plastic tray, white

## DISTINGUISHING FEATURES

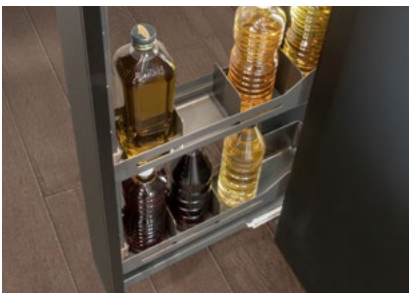

- Standard larder pull-out for extra space and greater convenience in any kitchen
- A full overview of the unit's contents with one easy movement
- Also available for narrow units (15 cm at the narrowest)
- Access from two sides
- A choice of Libell and Fiore metal shelves, chrome baskets or plastic trays
- The height-adjustable shelves help to make best use of the available space
- Soft opening and closing
- Moves smoothly and quietly
- ClickFixx assembly and easy adjustment

## OPTIONS



### Divider

Magnetic dividers are a flexible way for you to organise the space on your Libell and Fiore shelves and stop stored items from falling out of the unit.



### Non-slip mat

The non-slip mat for Libell and Fiore shelves stops the unit's contents from sliding around.

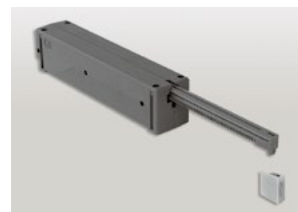

### E-Touch

Just touch the unit door to open and close the unit automatically.

## TECHNICAL ILLUSTRATION

<b>B= Unit widths</b>	150/200/250/300/400/450 mm
<b>T= Interior depth</b>	505 mm
<b>H= Interior height</b>	600–2260 mm

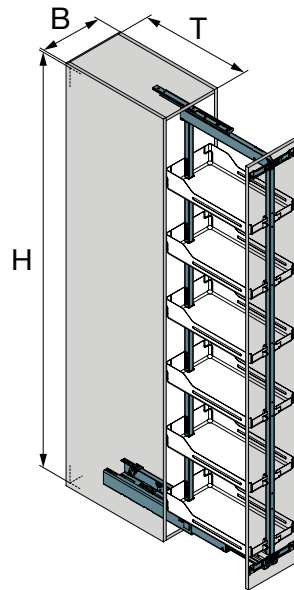

## LIST OF COMPONENTS

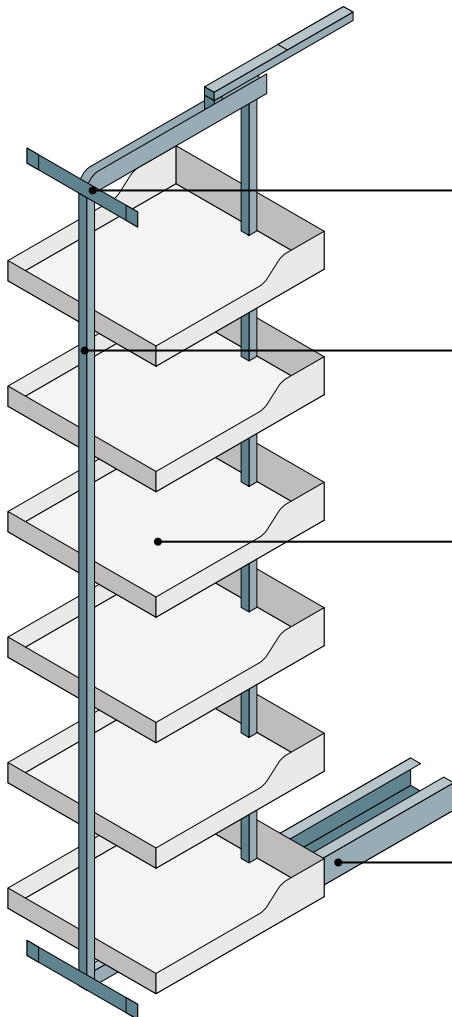

### Assembly material

Front bracket, stabiliser, extra hooks

→ 1.43

### Tubular frame

height-adjustable

→ 1.39

fixed

→ 1.40

### Accessories

Clip-on shelf Libell

→ 1.40

Clip-on shelf Fiore

→ 1.40

Clip-on basket Excellent

→ 1.42

Clip-on tray

→ 1.42

E-Touch

→ 1.43

### Extension runner

Full-extension runner

→ 1.39

Standard-extension runner

→ 1.39



### Full-extension runner Compact Hochschrank Standard

For tubular frames Hochschrank Standard

- Includes Softopen and Softclose
- Includes automatic synchronisation
- Includes ClickFixx / quick assembly

Load capacity: 120 kg

	Surface	Width	Depth	Height	Art. No.
	white	120	490	55	100.0874.01
	silver	120	490	55	100.0874.02
	anthracite	120	490	55	100.0874.43



### Standard-extension runner Single Hochschrank Standard

For tubular frames Hochschrank Standard

- Includes Softopen and Softclose
- Includes ClickFixx / quick assembly

Load capacity: 100 kg

	Surface	Width	Depth	Height	Art. No.
	white	79	495	55	100.0922.01
	silver	79	495	55	100.0922.02
	anthracite	79	495	55	100.0922.43



### Height-adjustable tubular frame Hochschrank Standard

For full-extension runner Compact and standard-extension runner Single Hochschrank Standard

- Includes ClickFixx / quick assembly

Interior height = Height of tubular frame + Height of extension runner

Interior height	Surface	Width	Depth	Height	Art. No.
900 - 1300	white silver anthracite		495	845 - 1245	100.0590.xx
1200 - 1600			495	1145 - 1545	100.0592.xx
1600 - 2000			495	1545 - 1945	100.0594.xx
1805 - 2260			495	1750 - 2205	100.0596.xx

Colour code .xx: 01 = white, 02 = silver, 43 = anthracite



### Fixed tubular frame Hochschrank Standard

For full-extension runner Compact and single-extension runner Single Hochschrank Standard

- Includes ClickFixx / quick assembly

Interior height = Height of tubular frame + Height of extension runner

Interior height	Surface	Width	Depth	Height	Art. No.
1999	white		495	1944	100.0598.01
1999	silver		495	1944	100.0598.02
1999	anthracite		495	1944	100.0598.43



### Clip-on shelf Libell

To clip onto the tubular frame Hochschrank Standard

Unit width	Surface	Width	Depth	Height	Art. No.
150*	white silver anthracite	100	470	92	100.0890.xx
200		150	470	92	100.0891.xx
250		200	470	92	100.0688.xx
300		250	470	92	100.0690.xx
400		350	470	92	100.0692.xx
450		400	470	92	100.0693.xx

Colour code .xx: 01 = white, 12 = silver, 43 = anthracite

\* Clip-on shelves for unit width 150 mm are compatible only with the standard-extension runner Single (100.0922.xx)

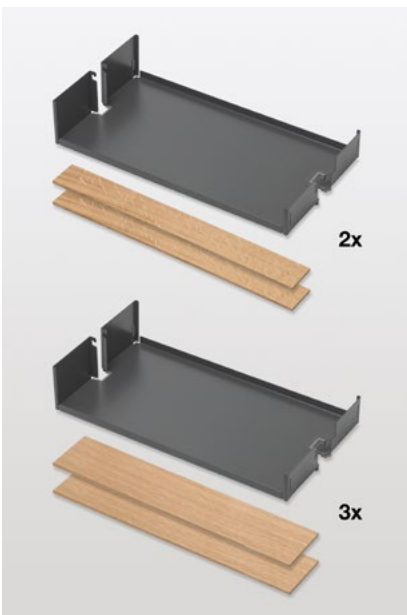

### Clip-on shelf set Fiore

To clip onto the tubular frame Hochschrank Standard

Set includes:

- 5 clip-on shelves Fiore
- 4 wooden rails oak medium (height 52 mm)
- 6 wooden rails oak high (height 87 mm)

Unit width	Surface	Width	Depth	Height	Art. No.
150	anthracite	100	462	90	100.0938.43
300	anthracite	250	462	90	100.0942.43
400	anthracite	350	462	90	100.0943.43

Other widths available on request

\* Clip-on shelves for unit width 150 mm are compatible only with the standard-extension runner Single (100.0922.43)

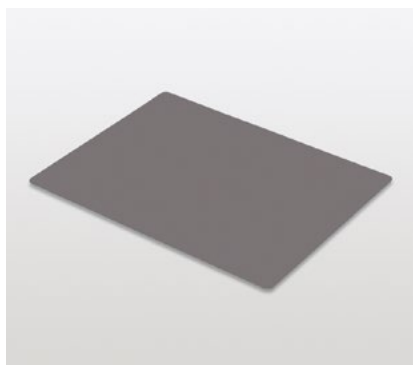

### Non-slip mat magnetic

For the Libell clip-on shelf for Hochschrank Standard

- Magnetic
- Easy to remove for cleaning

oyster white = for white shelves

walnut grey = for silver/anthracite shelves

Unit width	Surface	Width	Depth	Height	Art. No.
150	oyster white walnut grey	67	390	0.5	200.1277.xx
200		105	390	0.5	200.1278.xx
250		155	415	0.5	100.0697.xx
300		205	415	0.5	100.0699.xx
400		305	415	0.5	100.0701.xx
450		355	415	0.5	200.1365.xx

Colour code .xx: 57 = oyster white, 56 = walnut grey

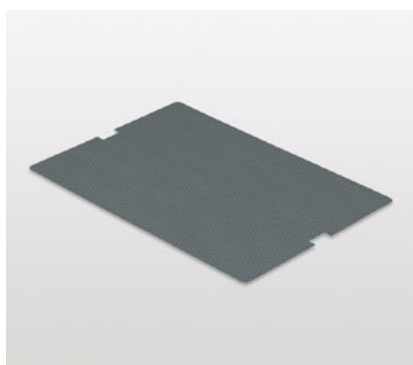

### Non-slip mat Standard

For the Libell and Fiore clip-on shelf for Hochschrank Standard

- Gummed on both sides
- Raised diamond pattern
- Easy to remove for cleaning

Unit width	Surface	Width	Depth	Height	Art. No.
150	grey	65	440	1	100.0910.18
200	grey	115	440	1	100.0911.18
250	grey	165	440	1	100.0724.18
300	grey	215	440	1	100.0726.18
400	grey	315	440	1	100.0728.18
450	grey	365	440	1	100.0729.18



### Shelf divider

Magnetic divider for Fiore and Libell shelves

- Can be attached to the shelf (base or side) or the non-slip mat

	Surface	Width	Depth	Height	Art. No.
	white	85	26 / 3	90	100.0706.51
	grey	85	26 / 3	90	100.0706.52
	anthracite	85	26 / 3	90	100.0706.43

Order quantity: 4 pieces or a multiple per article number

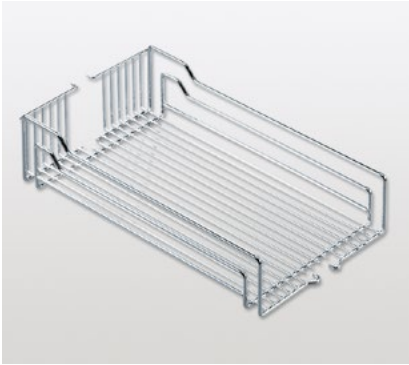

### Clip-on basket Excellent

To clip onto the tubular frame Hochschrank Standard

- Raised border rail prevents products from falling out

Unit width	Surface	Width	Depth	Height	Art. No.
300	chrome	250	467	110	100.0188.05
400	chrome	350	467	110	100.0189.05



### Clip-on tray

To clip onto the tubular frame Hochschrank Standard

- With drill pilot holes for border rails that can be screwed in place

Unit width	Surface	Width	Depth	Height	Art. No.
300	white	250	460	65	100.0174.01
400	white	350	460	65	100.0178.01



### Border rails

To screw on to the clip-on trays Hochschrank Standard

- Includes self-tapping mounting screws

Two border rails are required for each tray.

Unit width	Surface	Width	Depth	Height	Art. No.
300	chrome	89	435	40	100.0194.05
400	chrome	152	435	40	100.0196.05

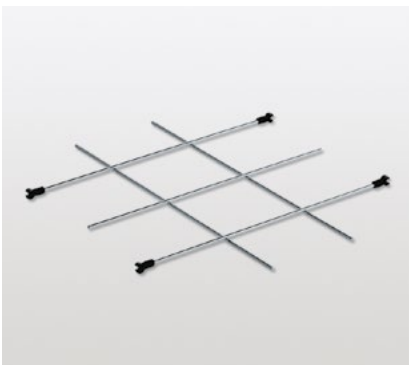

### Bottle partition

Can be clipped on to the border rail of clip-on trays Hochschrank Standard

For 300 mm-wide units = 8 compartments

For 400 mm-wide units = 12 compartments

Unit width	Surface	Width	Depth	Height	Art. No.
300	chrome	250	400		100.0272.05
400	chrome	350	400		100.0273.05



## E-Touch

Electronic door opener for full-extension runner Compact Hochschrank Standard

- For handle-free fronts – opens with a light tap
- Can be retrofitted

Impact force: max. 120 kg

Unit width: min. 300 mm

Requires: Softclose

Electromotive support: opening

Unit width	Surface	Width	Depth	Height	Art. No.
300	grey	68	333	77	100.0873.02



## Front bracket

For the tubular frame Hochschrank Standard

- With ClickFixx connection and 3-dimensional adjustment

Two-part set

Unit width	Surface	Width	Depth	Height	Art. No.
150/200/250	white	100			100.0892.01
150/200/250	silver	100			100.0892.02
150/200/250	anthracite	100			100.0892.43



## Front bracket

For the tubular frame Hochschrank Standard

- With ClickFixx connection and 3-dimensional adjustment

Two-part set

Unit width	Surface	Width	Depth	Height	Art. No.
300	white	250			100.0585.01
300	silver	250			100.0585.02
300	anthracite	250			100.0585.43
400	white	350			100.0586.01
400	silver	350			100.0586.02
400	anthracite	350			100.0586.43





### Front stabiliser

Boosts the stability of the front panel (a bracket is placed over the tubular frame and affixed to the front panel)

	Surface	Width	Depth	Height	Art. No.
	white				100.0142.01
	silver				100.0142.02
	anthracite				100.0142.43



### Extra hooks

For fully extended height-adjustable tubular frames

- Full use of the tubular frame

Two-part set

	Surface	Width	Depth	Height	Art. No.
	white			125	100.0163.01
	silver			125	100.0163.02
	anthracite			125	100.0163.43

