

Pecasa



Smart Furniture
Made in Switzerland
by peka

Pecasa – smart furniture by peka

Pecasa means smart living for greater comfort. Create your own customised space in just a few easy steps: a simple, clear and adaptable solution.

Thanks to Pecasa, you can enjoy maximum flexibility with minimum effort. You can attach any combination of shelves, cabinets, desks or clothes rails to the central wall profile and reposition them however you like. Ideal for living areas, home offices, dressing areas, hallways and shops.



reddot award 2018
winner





≡	6 The Pecasa system
□	11 Pecasa Living
▭	19 Pecasa Home Office
	29 Pecasa Dressing
▮	37 Pecasa Hallway
	42 Planning guide



How the Pecasa system works

Pecasa consists of a few simple, but highly versatile components that can be combined in an infinite variety of ways. peca supplies a wall profile with a built-in cable duct, plus shelf supports, unit support brackets and metal shelves. You then arrange them however you like to create your own personalised furniture solution. You can even add lighting or a TV to your Pecasa system thanks to the cable duct in the side of the wall profile.

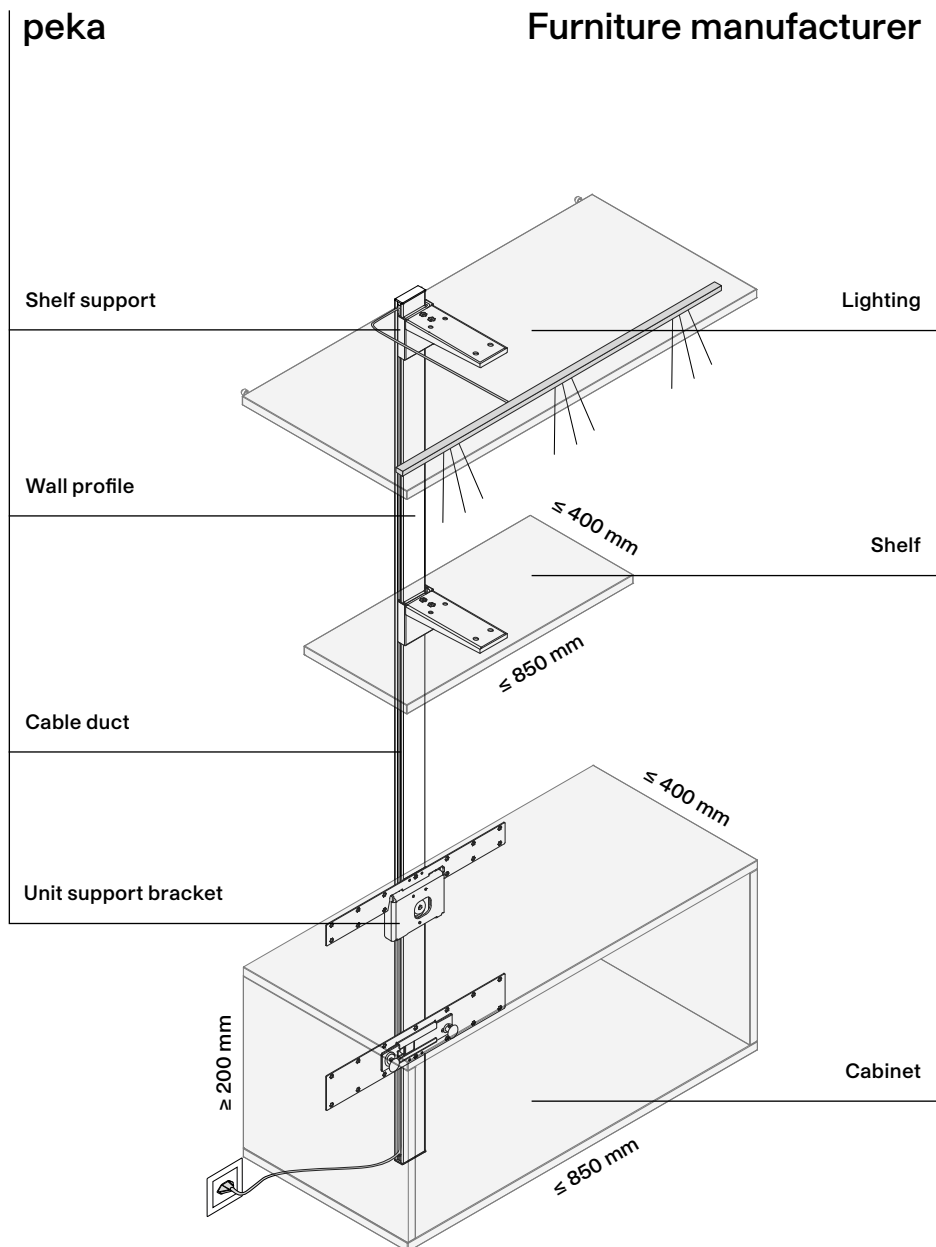

Flexible design

Thanks to its central wall profile, Pecasa is the last word in flexibility: its modular components can be moved into any position at any time, be they table tops, shelves, cabinets, or other items.

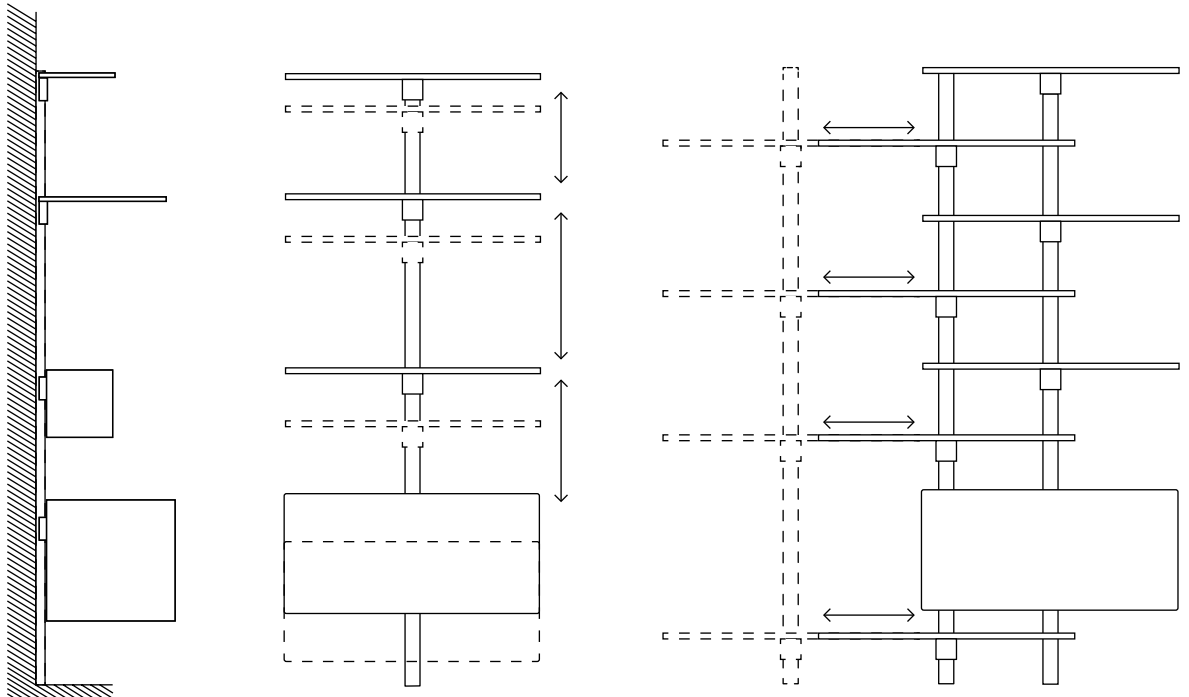

You are free to choose a symmetrical or an asymmetrical look, use the whole height of the profile or just part of it, or lay out your components in a centred or staggered alignment. The choice is yours!

Pecasa shelf supports

Three different shelf supports for three different materials: • solid wood • wood composites • glass
Metal shelves come with built-in concealed shelf supports.

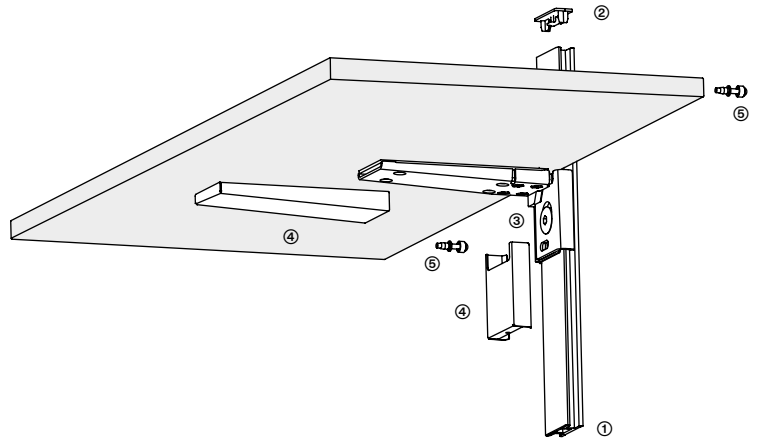

- ① Wall profile, including cover profile
- ② Cover cap for wall profile (top/bottom)
- ③ Shelf support, including clamp
- ④ Cover plates (vertical and horizontal)
- ⑤ Depth-adjustment screws



- Option 1: Metal shelf with built-in shelf support
- Option 2: Glass shelf
- Option 3: Wood-composite shelf

Let your creativity run free with Pecasa! Pecasa's range of shelf supports allows you to choose the materials and design that best suit your space and customise your shelves to suit your preferences. Clever combinations of glass, solid wood, wood composites and metal for a one-of-a-kind, wholly personalised unit.

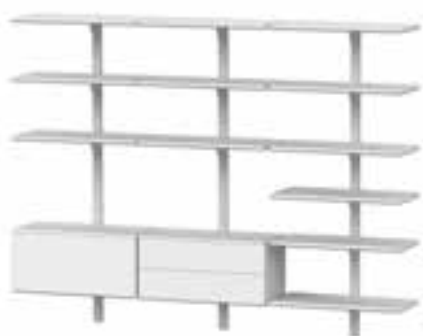

①



②



③



④

- ① White MDF
- ② Veneered particle board; glass shelves
- ③ Veneered particle board
- ④ Black MDF; metal shelves



Pecasa Living

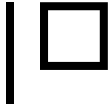

If you are looking for a solution that combines comfort and individuality, then Pecasa is the system for you! Choose components in your favourite colours and materials for that personal touch.

Want to build in lighting, a TV or a bookcase? No problem! Since Pecasa is structured around a central wall profile, you are free to design your living area however you like. A simple, customisable solution for any room.





①



②





①



②



③

- ① Bookend or tray: accessories in fine-textured powder-coated metal are the perfect addition to your Pecasa system.
- ② With its simple design and fine-textured powder-coated surface, this sturdy metal shelf is both practical and attractive. Available in black and white.
- ③ A universal bracket is all you need to mount a TV, mirror or picture on the wall profile.



Pecasa Living

Pecasa opens up limitless design possibilities for your space – one system, infinite options.



Benefits at a glance:

- + No matter if your room has lots of recesses or if its ceilings are high, low or even sloped, Pecasa is the perfect fit.
- + You can choose components in the colours and materials that best suit your space.
- + You can add lighting or a TV to your Pecasa system thanks to the cable duct in the side of the wall profile.



« Our house has a lot of character. It is full of nooks and crannies, and the rooms are not a uniform shape. I searched and searched for the right shelving system for our home – with Pecasa, I finally found what I was looking for. »



Pecasa Home Office



These days, practically every household has a home office. A home office has to provide space for a range of different needs: it should be a place to live and work, be just as welcoming for kids as for adults, and offer ample storage space and a decent work surface.

With Pecasa, shelves, desks and cabinets blend into the room as if they had always been there. Add a built-in cable duct and smart accessories into the mix, and your home office will be your new favourite place.





①



②

- ① Accessories, like this metal document tray, are available in four colours.
- ② The cable organiser is big enough to hold charging cables plus two EU five-outlet power strips.



①



②



③

- ① Smart carry box for everyday use.
- ② Practical, yet elegant: the pen tray with felt inlay comes in four colours.
- ③ Letter rack or bookend? You decide!



Pecasa Home Office

Living areas are increasingly doubling up as work spaces, so laptops, tablets and smartphones need to be within easy reach at all times. Pecasa has the answer.



Benefits at a glance:

- + An elegant, practical way to incorporate your office corner into your living area.
- + The adjustable components allow you to divide or blend your storage area and work space however you like.
- + Smart cable management for a range of electronic devices or a lighting system.



« Our home office is part of our everyday lives, but it was disorganised and cramped. Pecasa changed all that: now we have plenty of space and a smart organisation system, and our office looks good too! »

- ① The unit support bracket on the wall profile can be used for desks too.
- ② An excellent solution for sloping ceilings.
- ③ Shelf supports can be positioned at any height.
- ④ No more cables cluttering your work space thanks to the cable duct in the side of the wall profile.

Pecasa for children's rooms

Toy boxes, bookshelves, a desk for art projects... Pecasa has everything your child needs, making it a great addition to children's rooms too.

Besides, since the components can be positioned at any height, the system can be adjusted to suit each stage of your child's life, growing with them and offering plenty of flexibility.



①



Pecasa Dressing



Whether you have an elegant dressing room or just a corner in the bedroom, Pecasa is a perfect fit. Your favourite clothes should be stored with care and remain as crease-free as possible.

The Pecasa range includes a whole host of inventive solutions for storing trousers, shoes, blouses and shirts or jewellery in style.





A dressing room with a sloping ceiling





②



③

- ① The specially-developed trouser rack and hangers keep trousers crease-free. The hangers are included.
- ② The shelf support with built-in clothes rail can be combined with wood-composite shelves.
- ③ The elegant sloping shoe rack has plenty of space for your shoes and can be positioned at any height. It is made from a single piece of metal and is easy to clean.

Pecasa Dressing

With Pecasa, nothing could be easier than customising your dressing room to suit your needs. Whether you want to hang items, lay them flat or stand them up, there is space for everything.



Benefits at a glance:

- + Trousler rack for fuss-free, crease-free storage.
- + Shoe rack for shoes of any height.
- + Cabinet with drawers for smaller items of clothing or accessories.
- + Components can be positioned at any height, so there is plenty of space for everything.



« For so long, we dreamed of having a dressing room that was tailored to our needs. Now our dream has finally come true – and our dressing room is exactly how we always wanted it. »

- ① Sloping shoe rack
- ② Shelf with built-in clothes rail
- ③ Trousers rack with individual hangers
- ④ Hook rail for jewellery and accessories
- ⑤ A universal bracket can be used to fix a mirror to the wall profile



Pecasa Hallway



Hallways are often narrow, so it is important to make best use of the available space. At the same time, they play a key role in people's first impressions of your home. A compact, yet classy Pecasa system is the answer.

Hook rails for jackets and coats, cabinets for additional storage and metal shoe racks enable you to save space without compromising on style.





②



③

- ① Is your hallway too narrow for a clothes rail? A space-saving hook rail is the answer!
- ② The elegant sloping shoe rack has plenty of space for your shoes and can be positioned at any height. It is made from a single piece of metal and is easy to clean.
- ③ Shelf for magazines or brochures in hallways, waiting rooms or lobbies.



Pecasa Hallway

A hall stand should save space, while also offering plenty of room for storage. Pecasa is an elegant solution to this conundrum.



Benefits at a glance:

- + Save space by fitting a hook rail for hanging jackets and coats.
- + Stow shoes and boots neatly on height-adjustable shoe racks.
- + The cabinet is a convenient place to leave keys, wallets, gloves or hats.



« My hallway may be tiny, but I still have plenty of space to store jackets, hats, scarves and shoes. Pecasa has made the impossible possible! »

Need help?

Since Pecasa is tailored to your requirements, every Pecasa shelf system is unique. That is why we thought you might like a helping hand with planning yours:

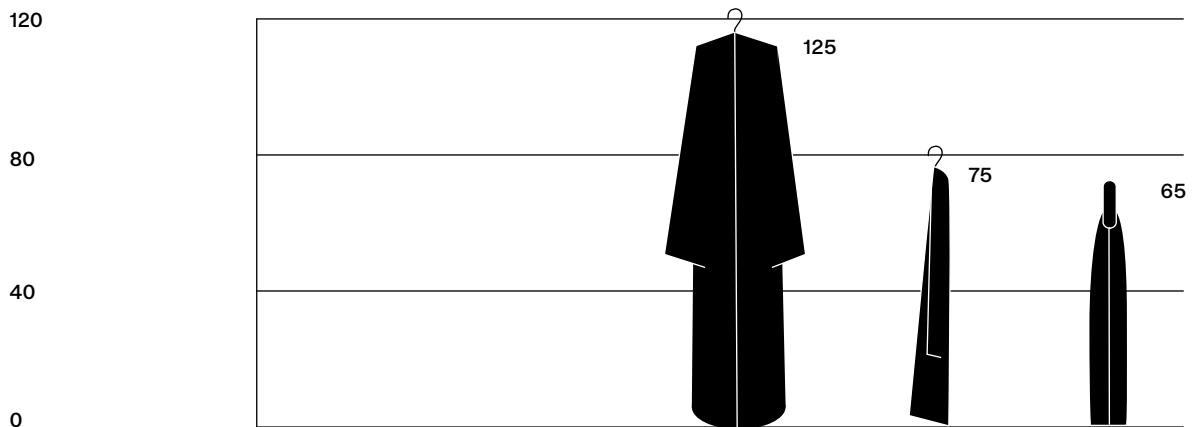
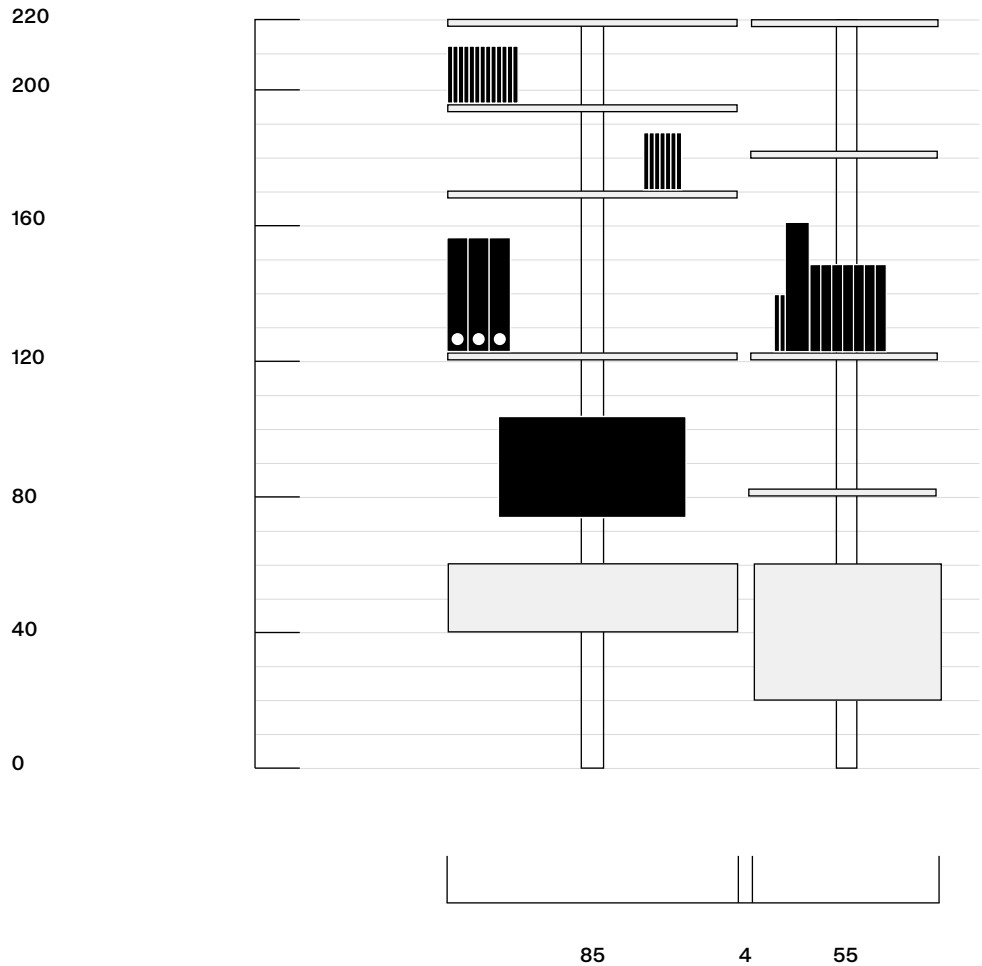



all measurements in cm

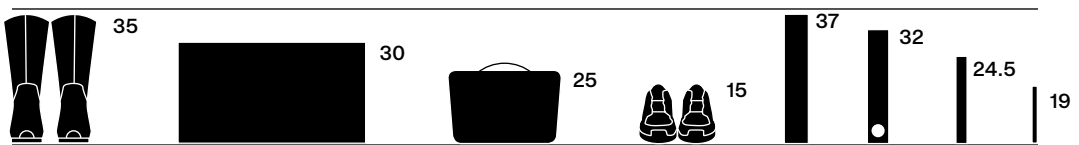
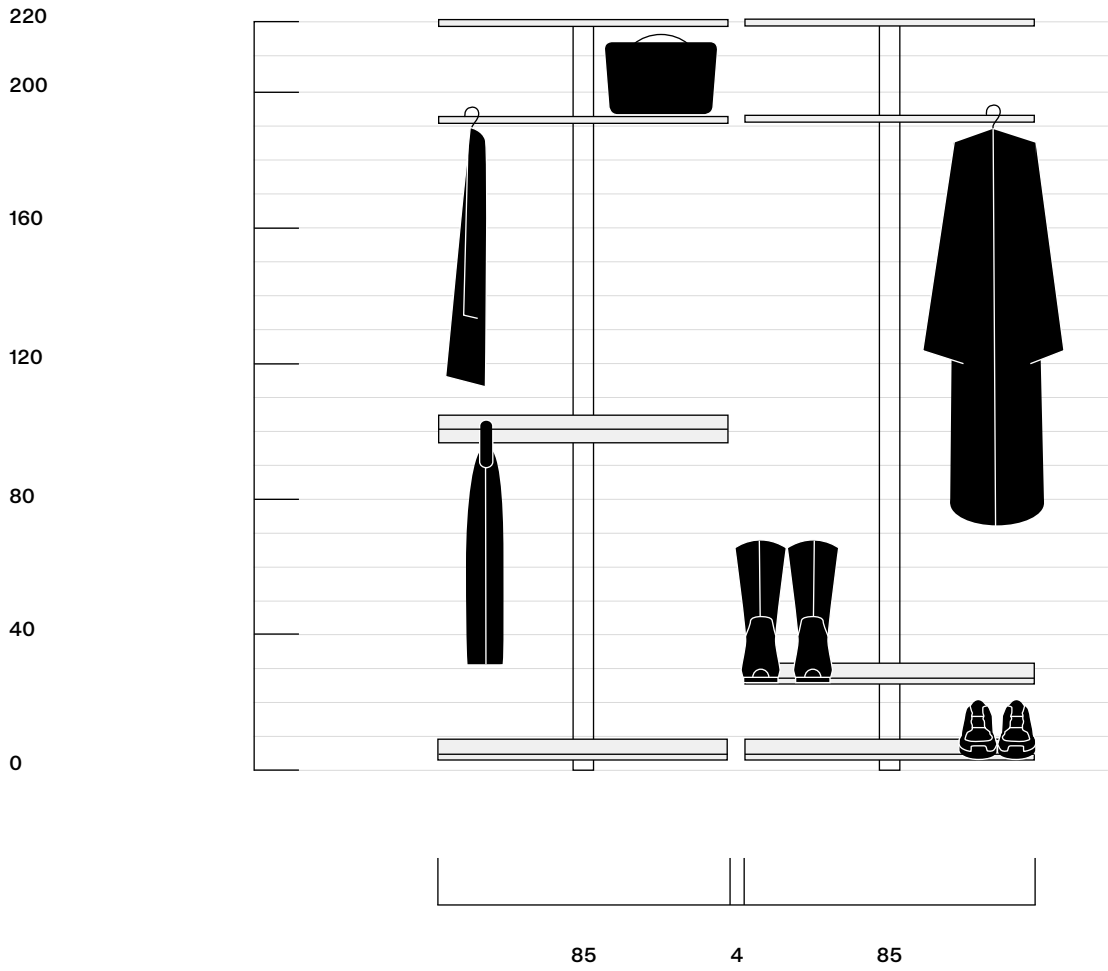

Pecasa – Smart Furniture
Made in Switzerland by peka

Contact us directly:

peka-metall AG
Luzernerstrasse 20
6295 Mosen, Switzerland

+41 41 919 94 00
peka@peka-system.ch



For installation videos,
installation instructions,
CAD data

and further information,
visit our website:
≡ www.peka-system.ch



Pecasa is a product of
peka-metall AG, Mosen
© All rights reserved

Layout: Studios Zürich Basel
Photographs: Martina Meier
Text: Mauro Werlen

