



SCARPI-4

Cabinet hanger

Heavy duty cabinet hanger: 45Kg./unit according to EN 15939

- > It allows three independent adjustments, easily accessible from the front side.
- > Concealed by an extra thin cover in different colours.
- > Available for knock-in or screw-on assembly.
- > The hanger is entirely made of steel and therefore it can be recycled without any problems.

1	SCARPI-4		274
	■ SCARPI-4 cabinet hanger		274
	■ Accessories		275
2	SCARPI-4 with safety system		276
	■ SCARPI-4 cabinet hanger with safety system		276
	■ Accessories		277

1 SCARPI-4

■ SCARPI-4 cabinet hanger

Euro-Screw hanger.

	Left	Right	
Zinc-plated	625.000.036	625.100.033	200

Euro-screw screws included.

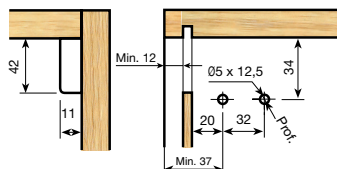

Knock-in hanger.

	Left	Right	
Zinc-plated	625.200.030	625.300.034	200

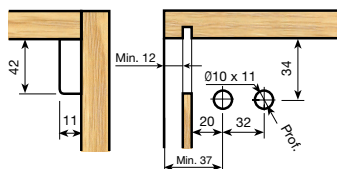

Screw-on hanger.

	Left	Right	
Zinc-plated	625.400.031	625.500.035	200

Ø5 x 16 screws included.

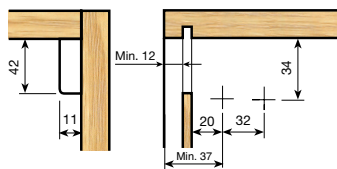

Cover.

		Left	Right	
White	RAL 9001	639.000.003	639.100.000	400
White	RAL 9003	639.000.132	639.100.136	
Brown	RAL 8016	639.000.014	639.100.011	
Grey		639.000.143	639.100.140	
Oak	RAL 1002	639.000.191	639.100.195	200
Nickel		639.000.062	639.100.066	
Anthracite	RAL 7043	639.000.316	639.100.313	

Covers with large flange.

		Left	Right	
White	RAL 9001	639.200.004	639.300.001	400
White	RAL 9003	639.200.133	639.300.130	
Brown	RAL 8016	639.200.015	639.300.012	
Grey		639.200.144	639.300.141	
Oak	RAL 1002	639.200.192	639.300.196	
Anthracite	RAL 7043	639.200.310	639.300.314	
Nickel		639.200.063	639.300.060	

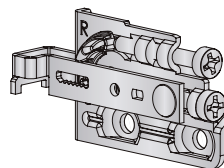

3 Adjustments	
Height	13mm.
Front	17mm.
Side	8mm.

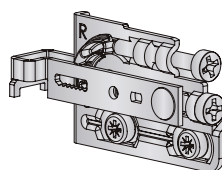
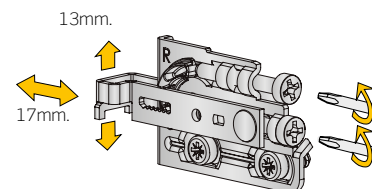

3 Adjustments	
Height	13mm.
Front	17mm.
Side	8mm.

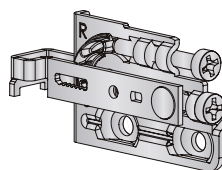

3 Adjustments	
Height	13mm.
Front	17mm.
Side	8mm.

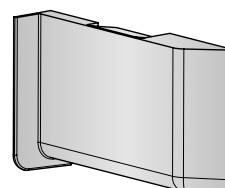
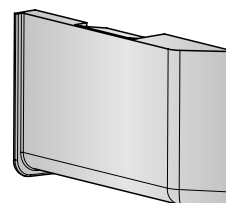

■ Accessories

Bag of accessories.

Zinc-plated	620.400.105	 200
-------------	-------------	---

Packed in boxes containing 200 bags. Each bag containing 1 double wall mounting plate. (B), 4 screws Ø4,5 x 45 (C), and 4 plastic wall plugs Ø8 x 40 (D).

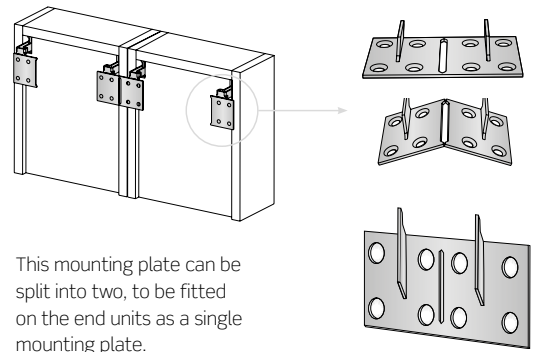

This mounting plate can be split into two, to be fitted on the end units as a single mounting plate.

Double wall mounting plate.

Zinc-plated	623.000.033	 200
-------------	-------------	---

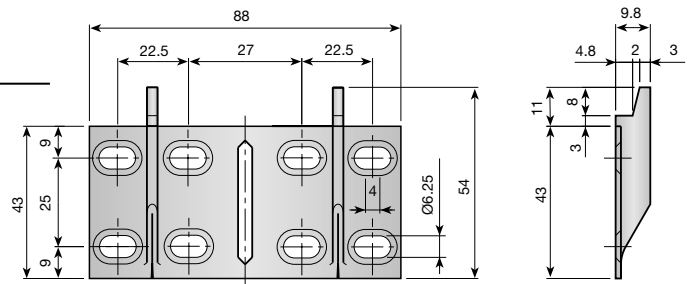

Screws Ø4,5 x 35.

Zinc-plated	982.435.031	 5.000
-------------	-------------	---



Plastic wall plugs Ø6 x 30.

Natural	662.130.302	 1.000 or 10.000
---------	-------------	---

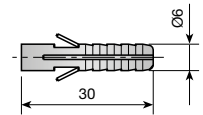

Plastic wall plugs Ø8 x 40.

Natural	662.240.106	 1.000 or 10.000
---------	-------------	---

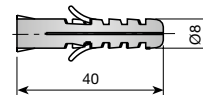

Square screw hook.

Zinc-plated	661.200.035	 1.000
-------------	-------------	---

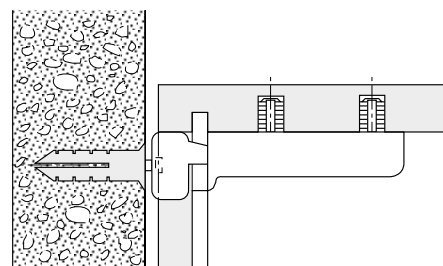
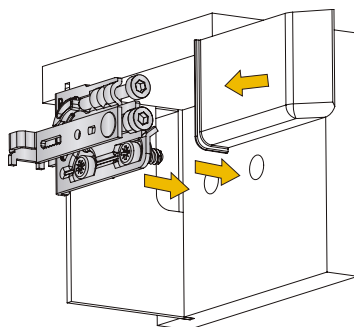
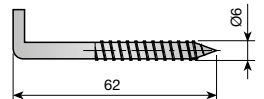

2 SCARPI-4 WITH SAFETY SYSTEM

■ SCARPI-4 cabinet hanger with safety system

Euro-Screw hanger with safety system for plate

	Left	Right	
Zinc-plated	629.800.032	629.900.036	200

Euro-screw screws included.

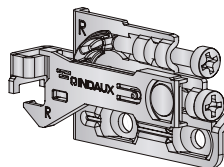
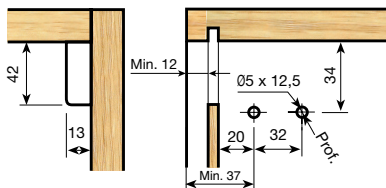

3 Adjustments	
Height	13mm.
Front	17mm.
Side	6mm.

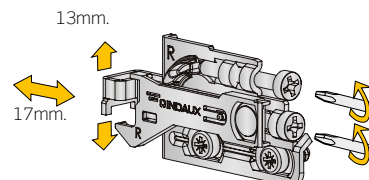

Knock-in hanger with safety system for plate

	Left	Right	
Zinc-plated	629.600.031	629.700.035	200

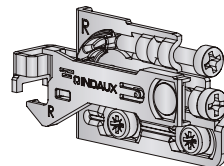
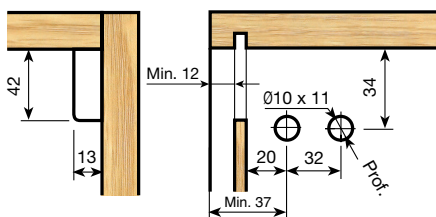

3 Adjustments	
Height	13mm.
Front	17mm.
Side	6mm.

Screw-on hanger with safety system for plate

	Left	Right	
Zinc-plated	629.400.030	629.500.034	200

Ø5 x 16 screws included.

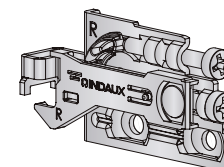
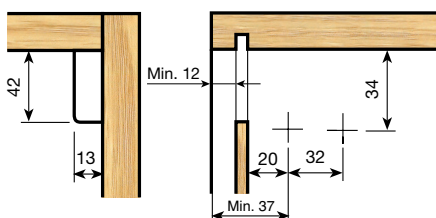

3 Adjustments	
Height	13mm.
Front	17mm.
Side	6mm.

Covers with large flange.

	Left	Right	
White RAL 9001	639.200.004	639.300.001	400
White RAL 9003	639.200.133	639.300.130	
Brown RAL 8016	639.200.015	639.300.012	
Grey	639.200.144	639.300.141	
Oak RAL 1002	639.200.192	639.300.196	
Anthracite RAL 7043	639.200.310	639.300.314	
Nickel	639.200.063	639.300.060	

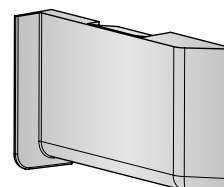

Locking clip

	Left	Right	
For plate	629.000.492	629.100.496	200
For square screw hook	629.200.493	629.300.490	

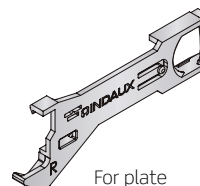

For plate

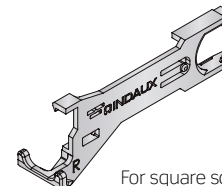

For square screw hook

■ Accessories

Bag of accessories.

Zinc-plated	628.950.103		200
-------------	-------------	---	-----

Packed in boxes containing 200 bags. Each bag containing 2 double wall mounting plates, 6 screws Ø4,5 x 45, and 6 plastic wall plugs Ø8 x 40.

Wall mounting plate.

Zinc-plated	628.900.031		200
-------------	-------------	---	-----

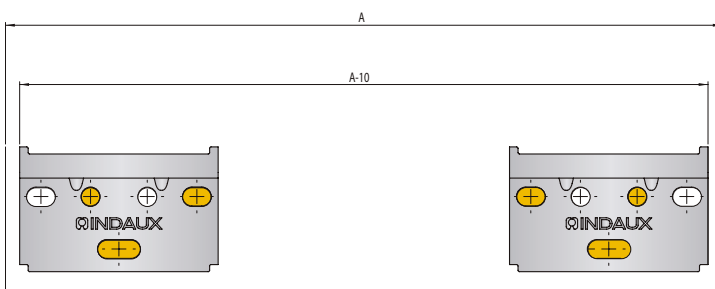
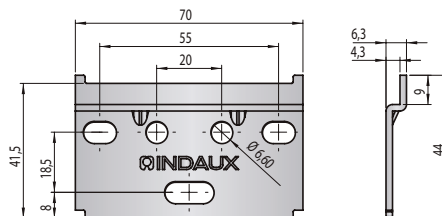
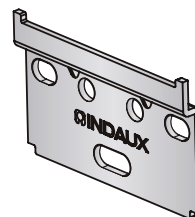

A: Distance between cabinet sides
* The screws must be placed in the indicated holes

Double wall mounting plate.

Length (mm.)	L	Zinc-plated	
200	158	623.315.033	150
250	208	623.320.036	150
300	258	623.325.032	150
350	308	623.330.035	100
400	358	623.335.031	100
450	408	623.340.034	100
500	458	623.345.030	52
550	508	623.350.033	52
600	558	623.355.036	52
650	608	623.360.032	52
700	658	623.365.035	52
750	708	623.370.031	52
800	758	623.375.034	52
900	858	623.385.033	40
1000	958	623.395.032	40
1200	1158	623.415.030	32
1350	1308	623.430.032	32

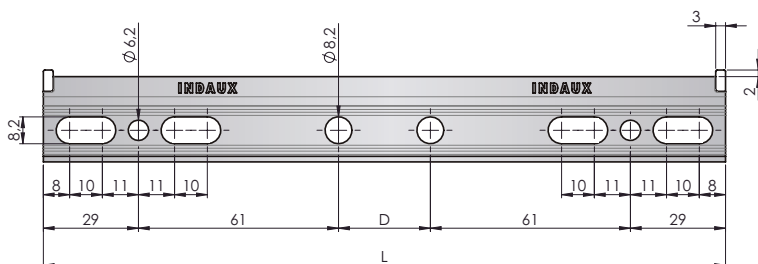

■ Accessories

Screws $\varnothing 4,5 \times 35$.

		
Zinc-plated	982.435.031	5.000



Plastic wall plugs $\varnothing 6 \times 30$.

		
Natural	662.130.302	1.000 or 10.000

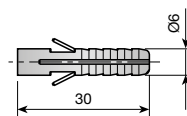

Plastic wall plugs $\varnothing 8 \times 40$.

		
Natural	662.240.106	1.000 or 10.000

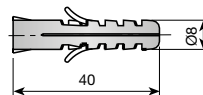

Square screw hook.

		
Zinc-plated	661.200.035	1.000

