



Slider M35-50
SALICE

Slider M35 - M50



M35 and **M50** are coplanar systems for full-height cabinets with doors weighing up to 35 and 50 kg respectively. Thanks to the exclusive patented design of the Slider series, sliding is intuitive, smooth and silent. **M35**, which can be motorised, has a lower track designed to allow the use of standard kitchen cabinet legs. **M50** is characterised by its versatility: suitable for many types of setting, it can be used with doors 33 or 17 mm above the ground.

M35 is intended especially to be used in the kitchen, while **M50** is ideal for wardrobes and storage cabinets in offices and shops.



Slider M35





Technical information

Coplanar two-door system with linear magnetic damper.

M35 is intended especially to be used in the kitchen.

Individual door properties:

- max. weight per door:
 - 35 Kg
- width:
 - min. 600 mm max. 2000 mm
- height:
 - min. 1200 mm max. 2200 mm
- **thickness:**
 - with recessed upper adjuster
min. 18 mm, max. with handle 45 mm
 - with external upper adjuster
min. 18 mm, max. with handle 40 mm
- **material:** wood
- Clipper frames can be used

Door adjustment:

- vertical adjustment ± 5 mm
- horizontal adjustment ± 3.5 mm
- front adjustment: - upper ± 3 mm
 - lower ± 3 mm

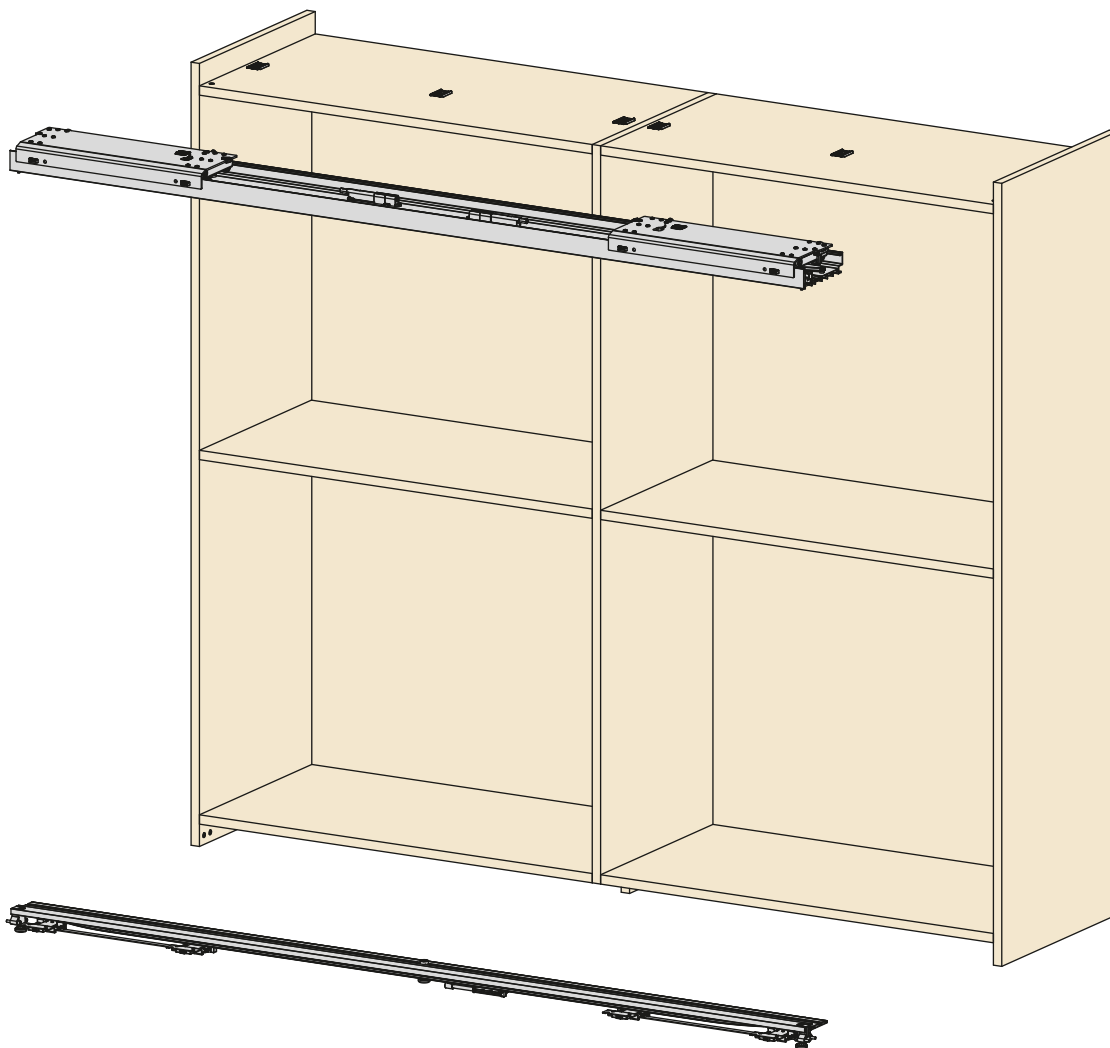

Key feature

- Soft closing with magnetic technology.
- Very easy to assemble.
- Super-smooth cushioned opening and closing
- High reliability, tested to 100,000 cycles.

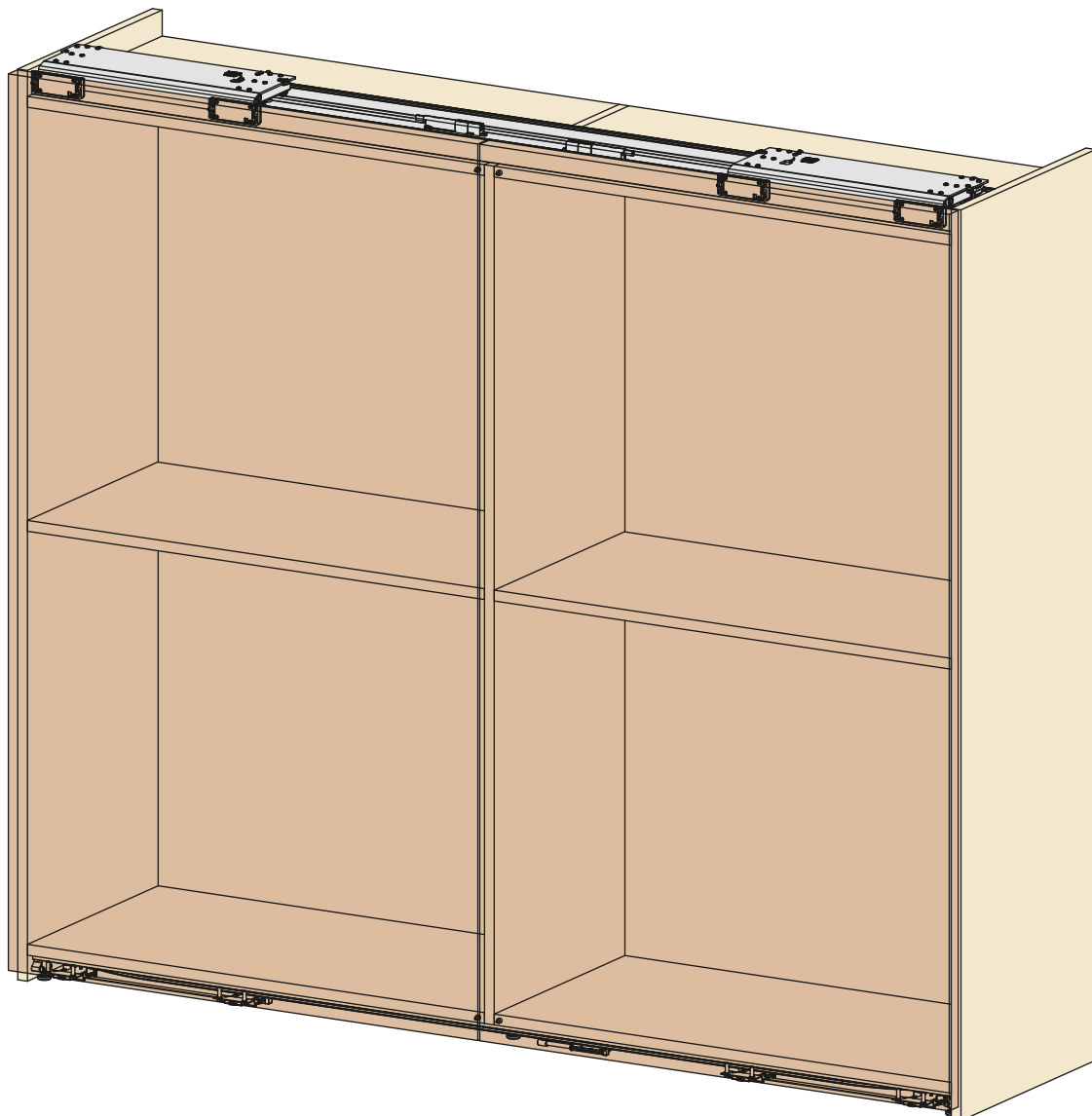

A27

Surface- mounted adjusters

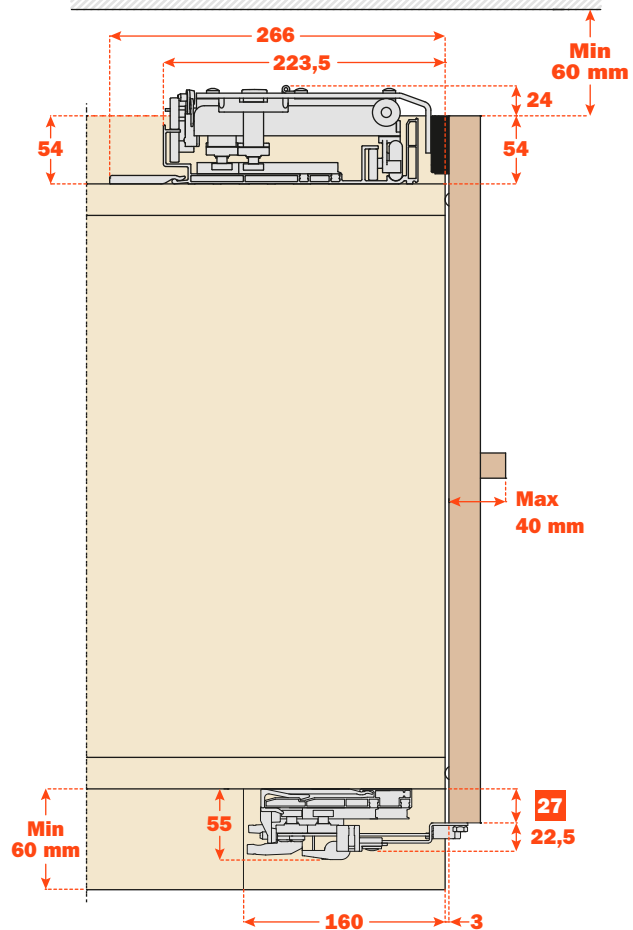

A27

Recessed adjusters

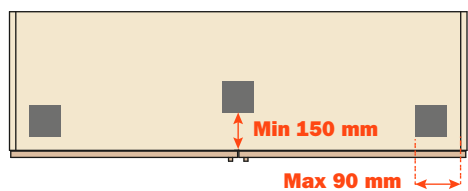
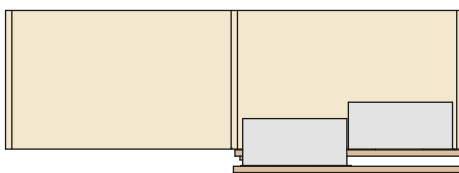
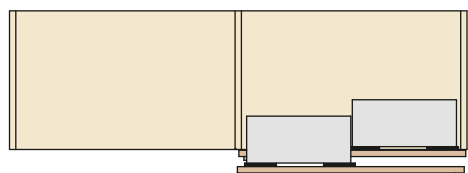
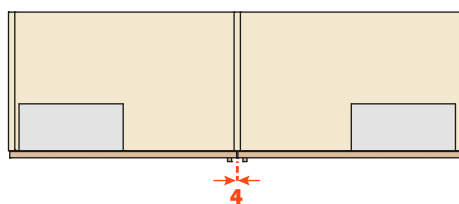
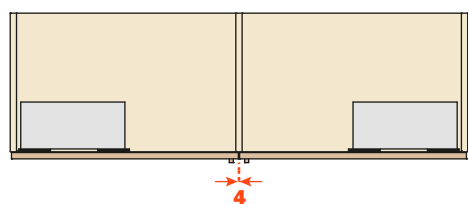
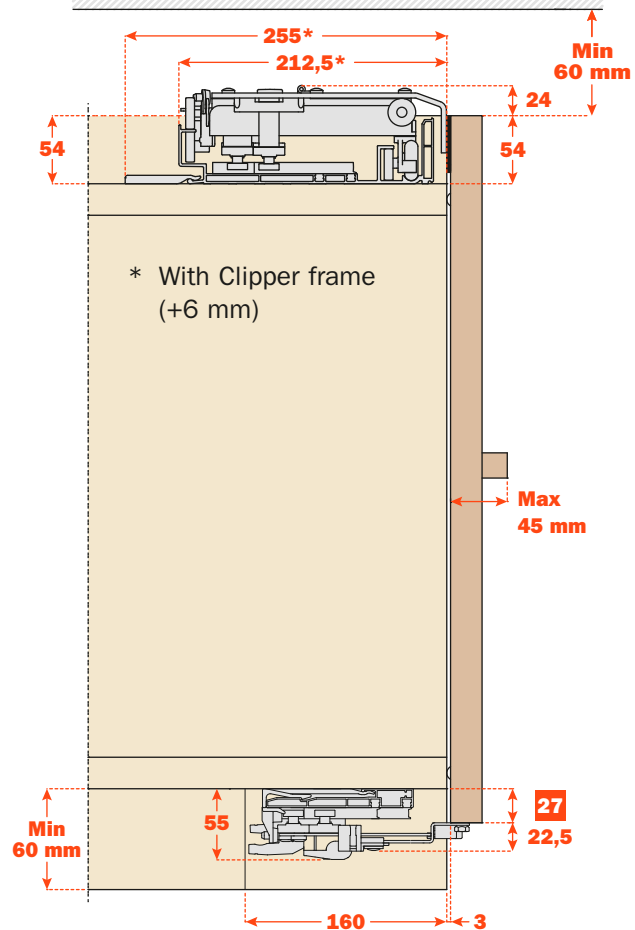

■ Foot

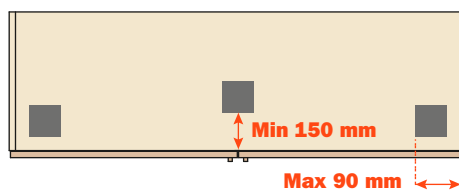

A43

Surface-mounted adjusters

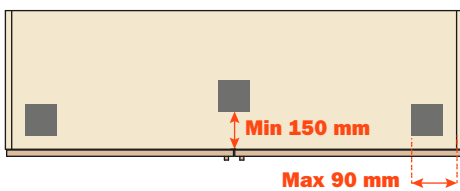
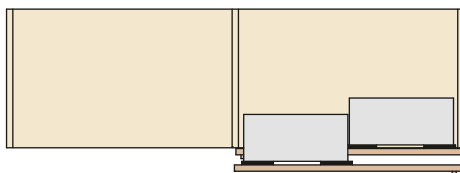
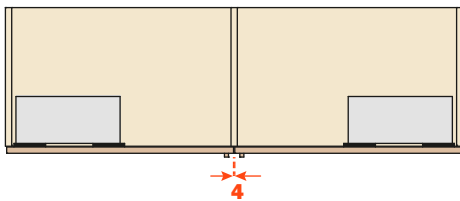
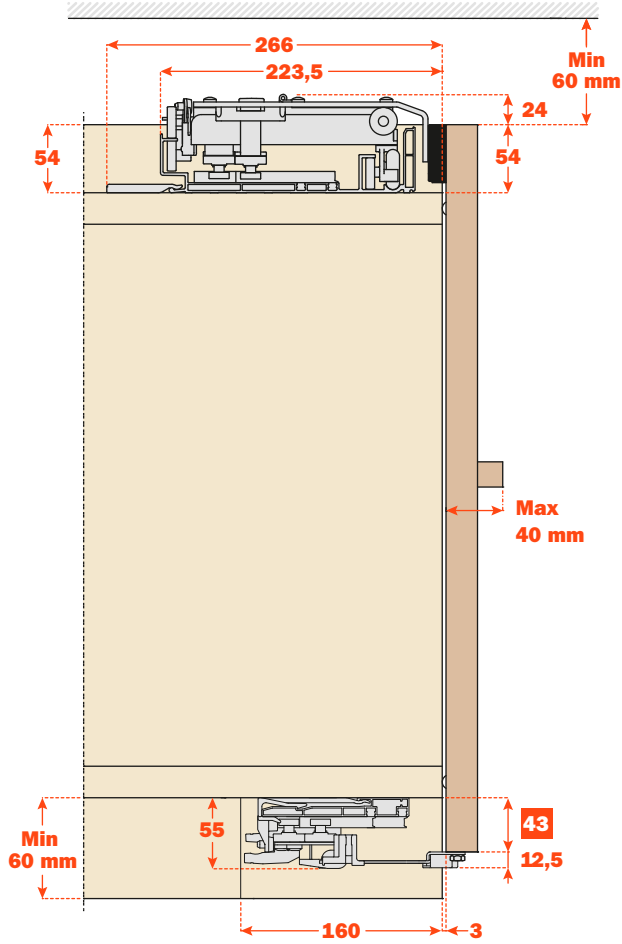

■ Foot

A43

Recessed adjusters

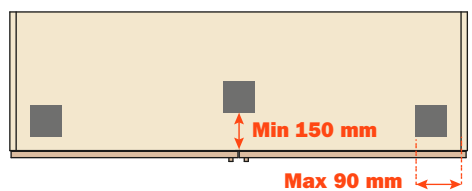
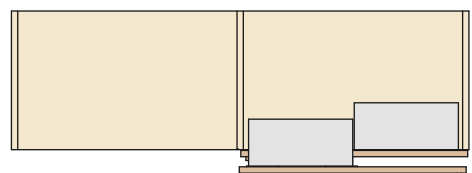
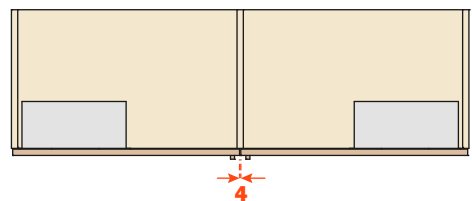
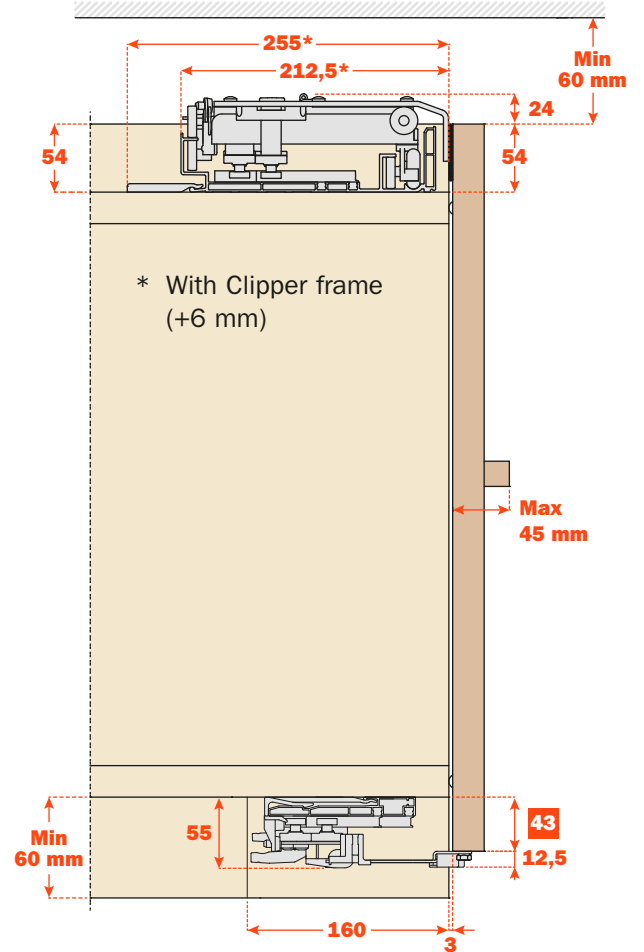

B27

Surface-mounted adjusters

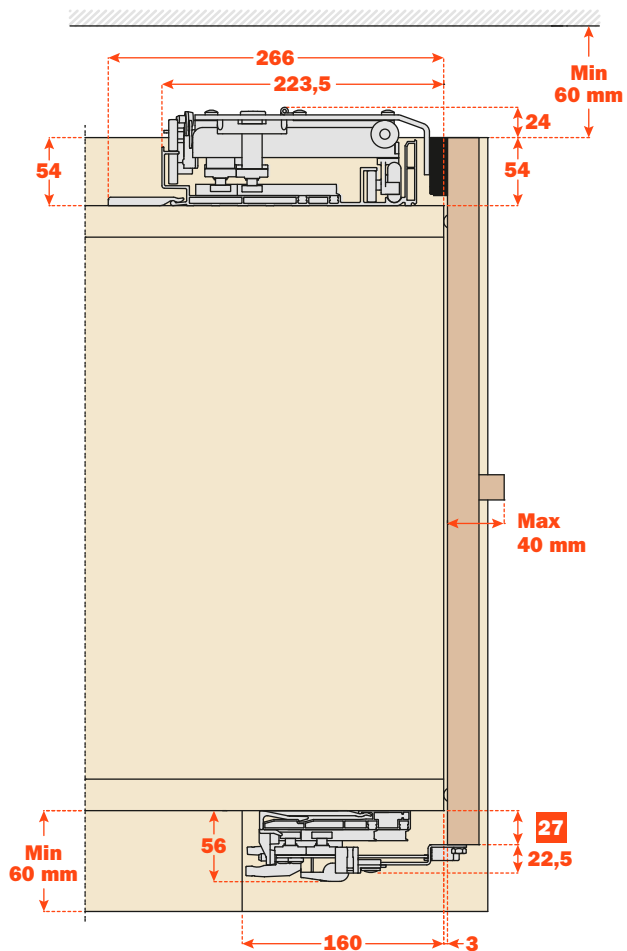

B27

Recessed adjusters

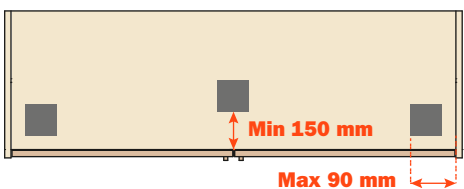
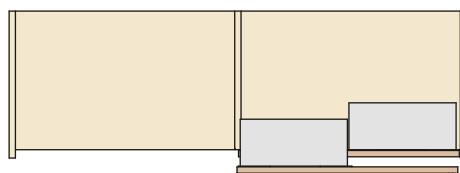
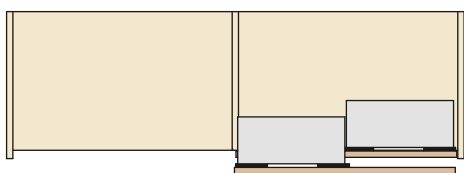
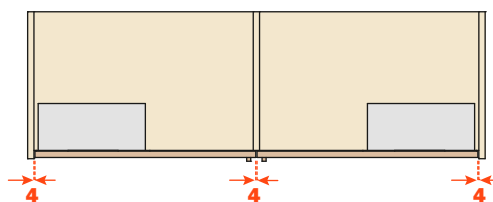
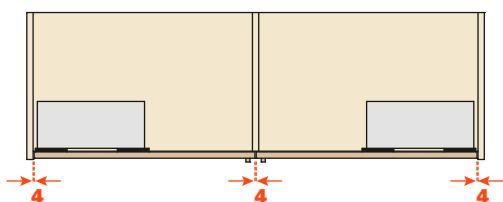
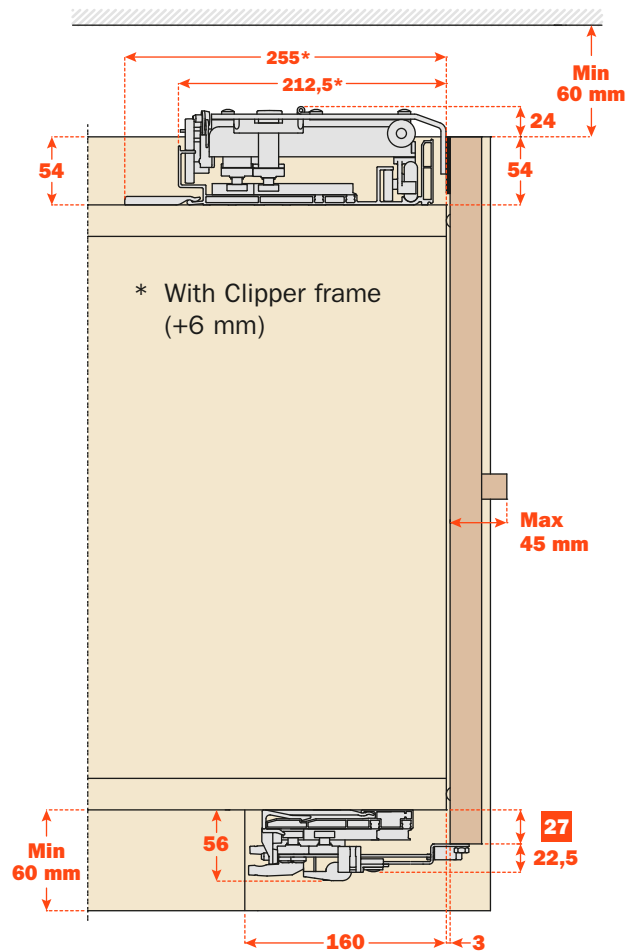

■ Foot

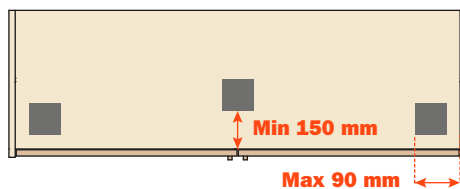

B43

Surface-mounted adjusters

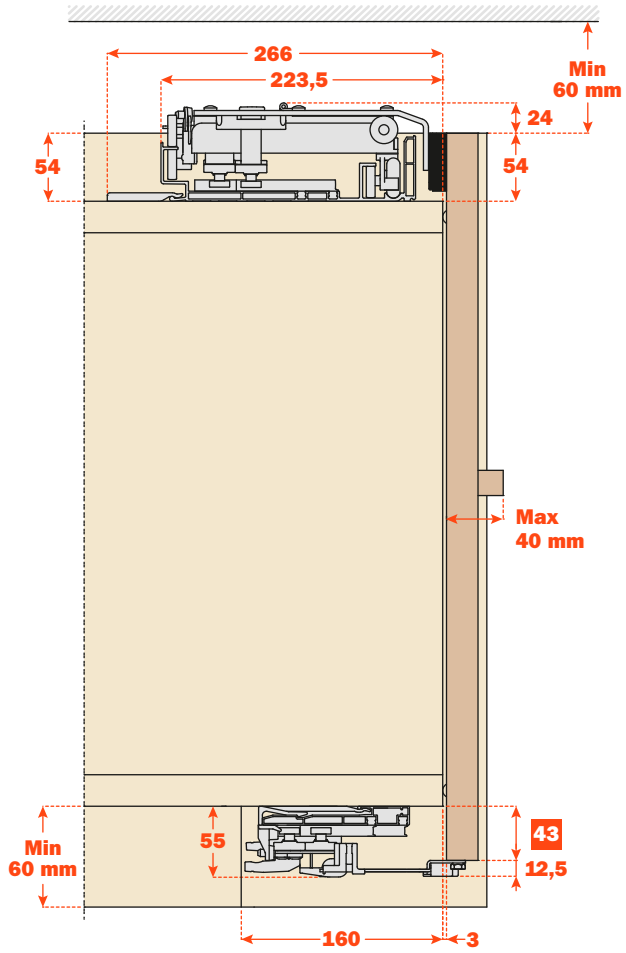

B43

Recessed adjusters

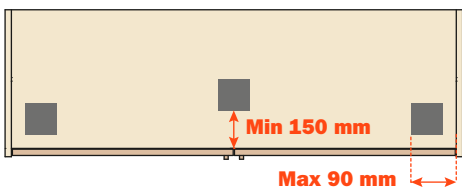
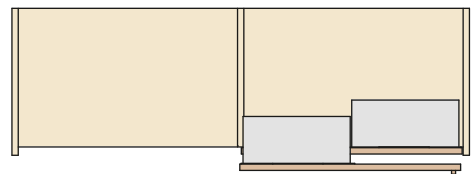
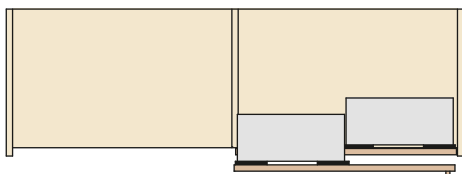
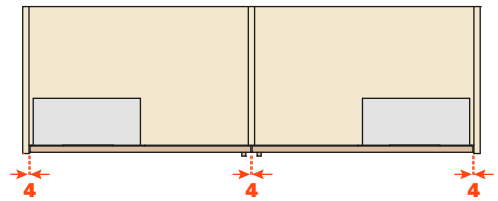
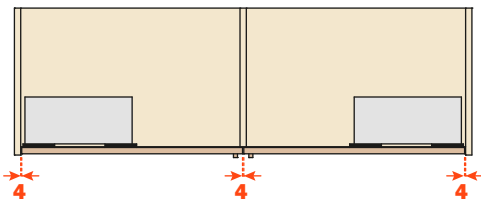
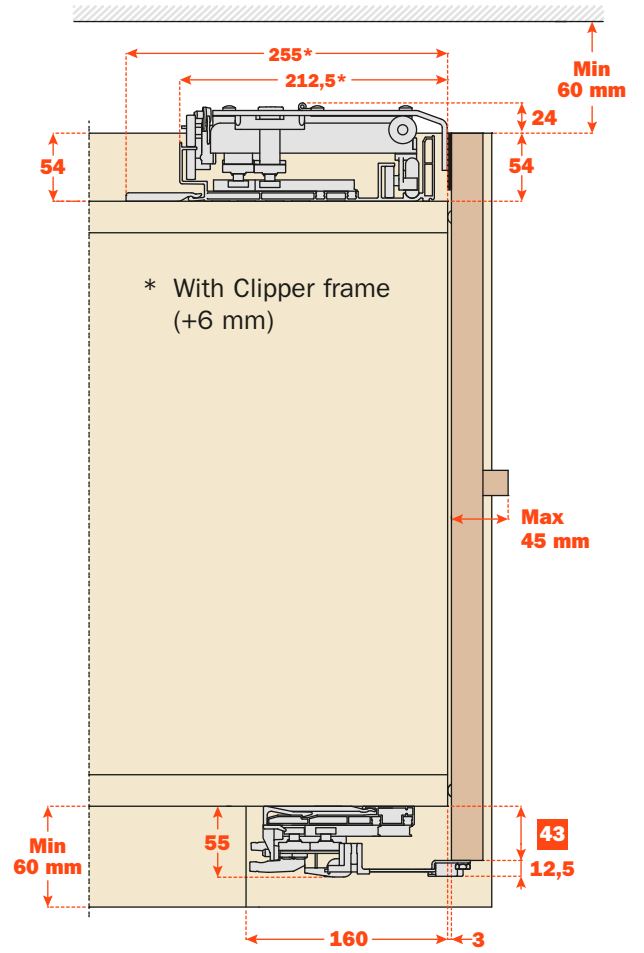

■ Foot

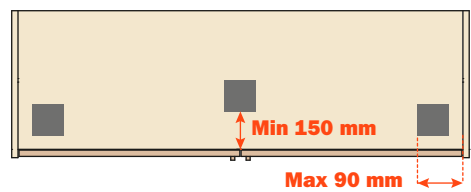

Customised systems

Slider M35 can be supplied in customised lengths i.e. designed for installation on cabinets with internal width (**LI**) equal to the length of the slider rail (**CP**).

Attention: clients can determine the extent to which the door will open based on variable **RAA** (distance between the central panel and edge of the door).

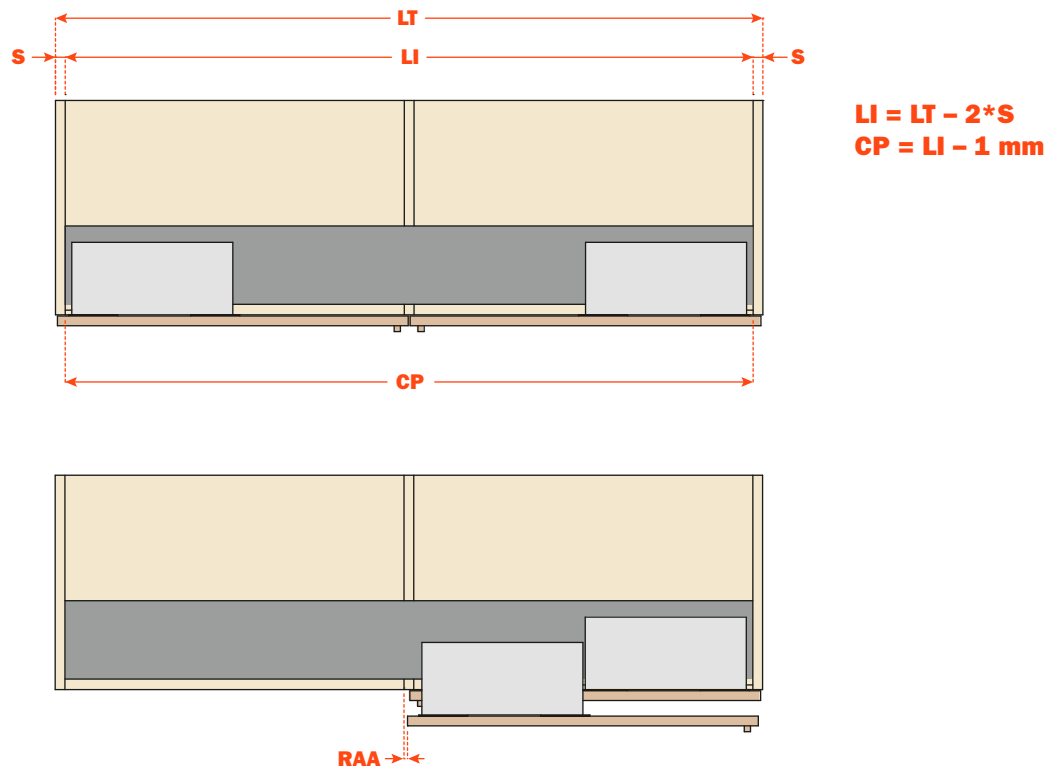

Slider M50





Technical information

Coplanar two-door system with linear magnetic damper.

M50 is ideal for wardrobes and storage cabinets in offices and shops.

Individual door properties:

- max. weight per door: 50 Kg
- width: min. 800 mm max. 2000 mm
- height: min. 1200 mm max. 3000 mm

• thickness:

- with recessed upper adjuster
min. 18 mm, max. with handle 45 mm
- with external upper adjuster
min. 18 mm, max. with handle 40 mm

• material: wood

- Clipper frames can be used

Door adjustment:

- vertical adjustment ± 5 mm
- horizontal adjustment ± 3.5 mm
- front adjustment: - upper ± 3 mm
- lower ± 3 mm

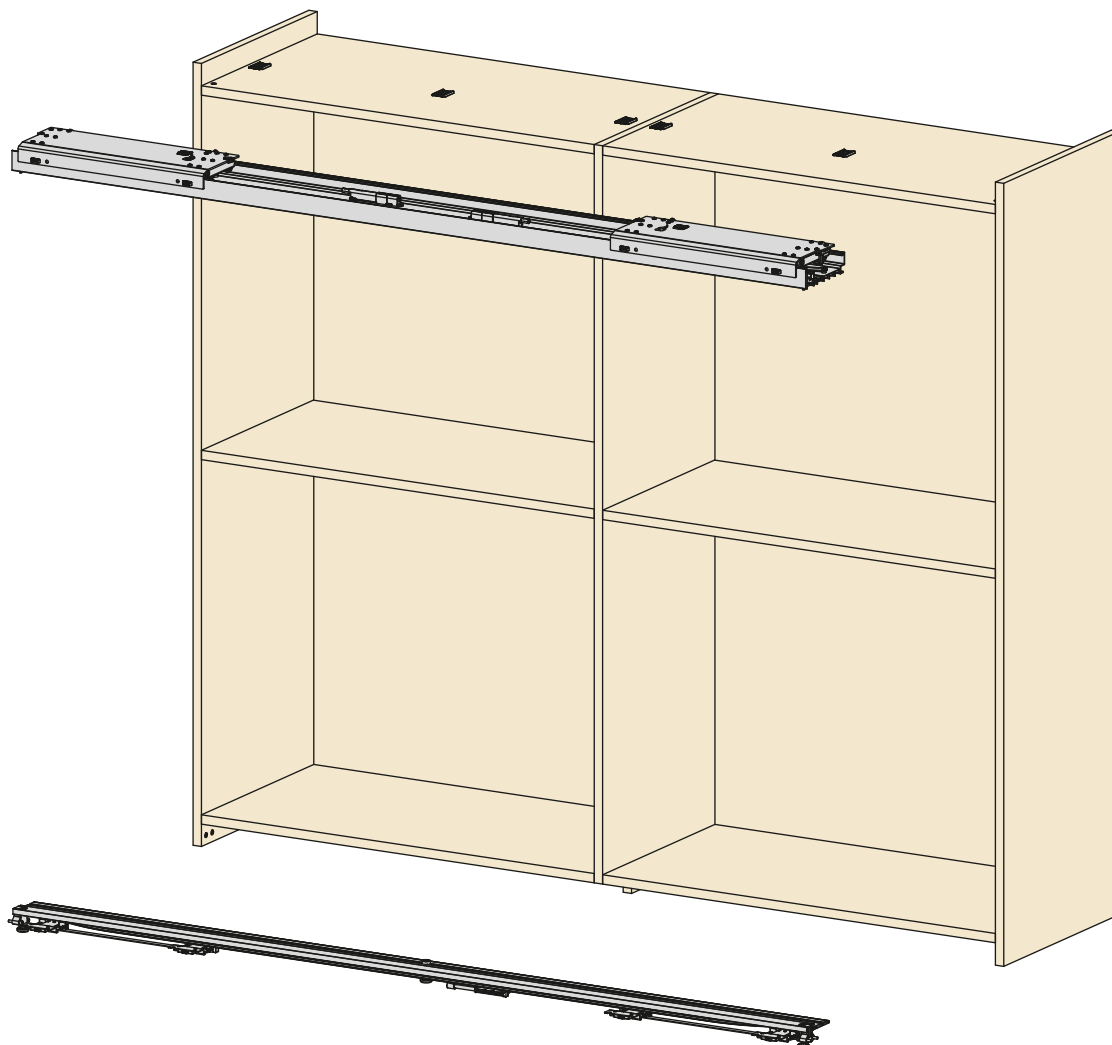

Key feature

- Soft closing with magnetic technology.
- Very easy to assemble.
- Super-smooth cushioned opening and closing
- High reliability, tested to 100,000 cycles.

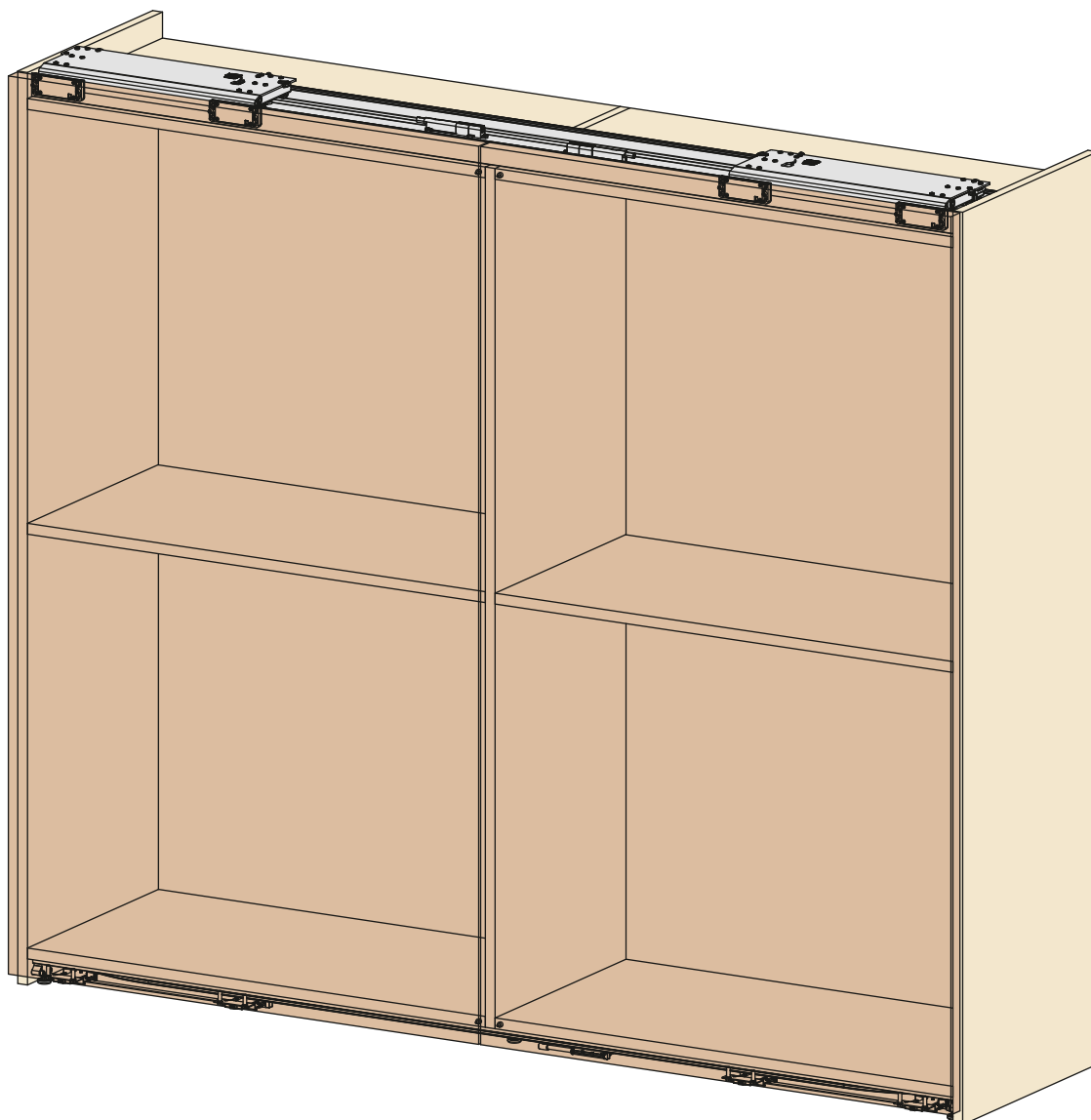

17 (M50)
Surface-mounted adjusters

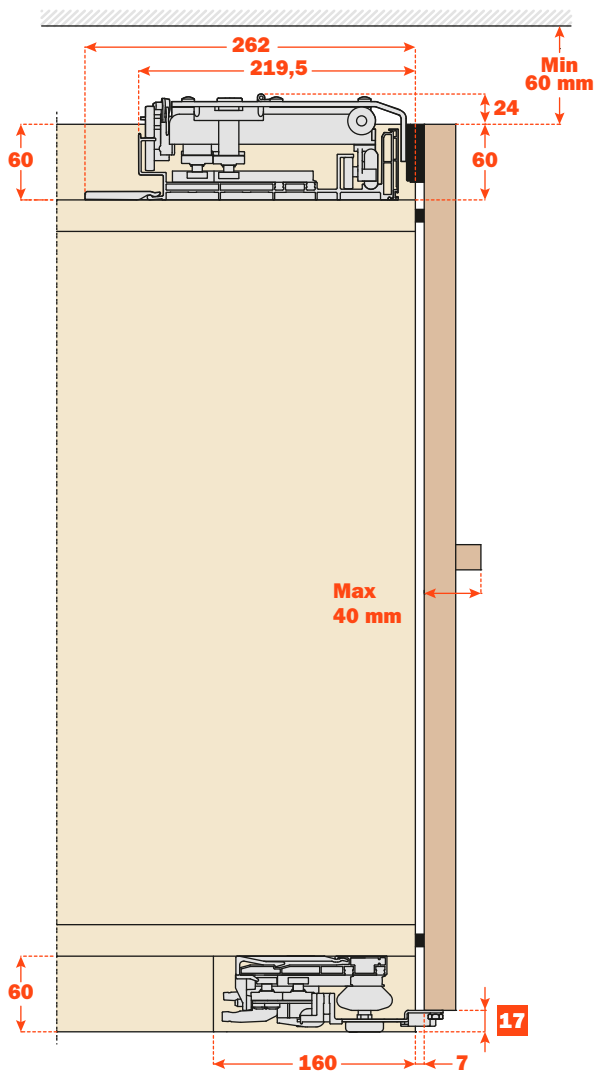

17 (M50)
Recessed adjusters

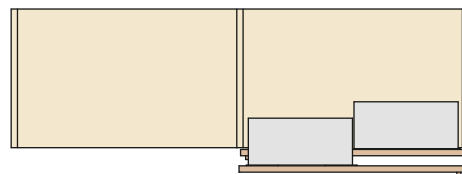
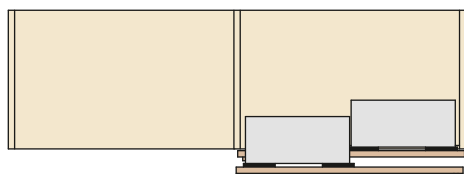
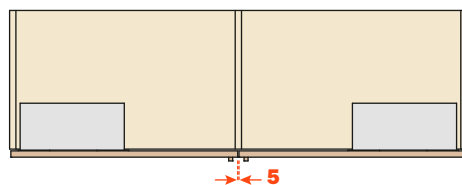
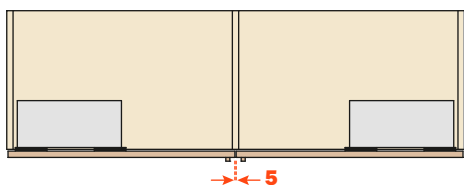
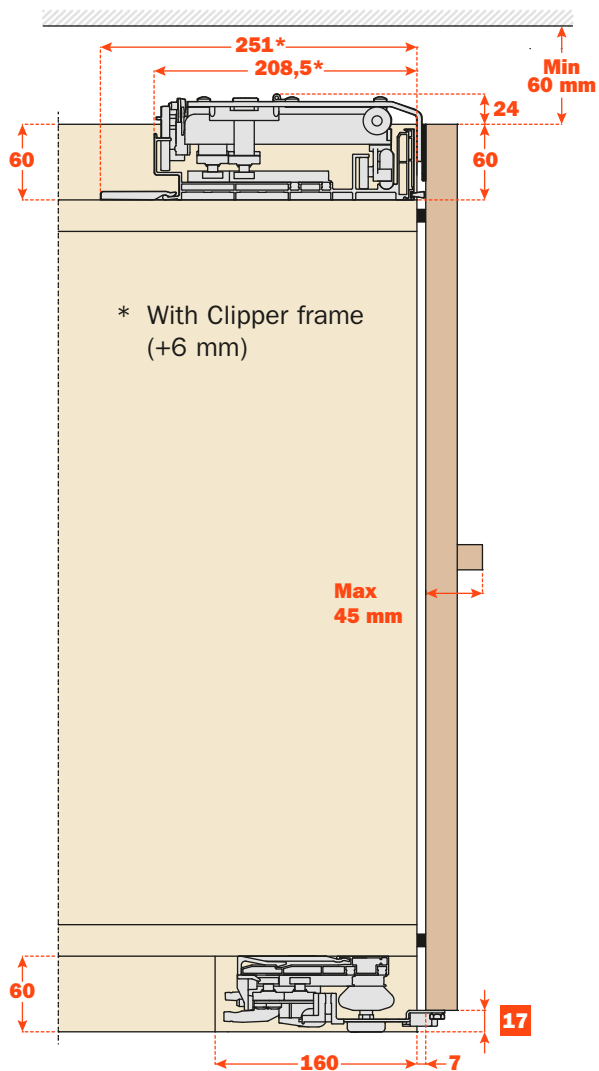

- Types of assembly

33 (M50)

Surface-mounted adjusters

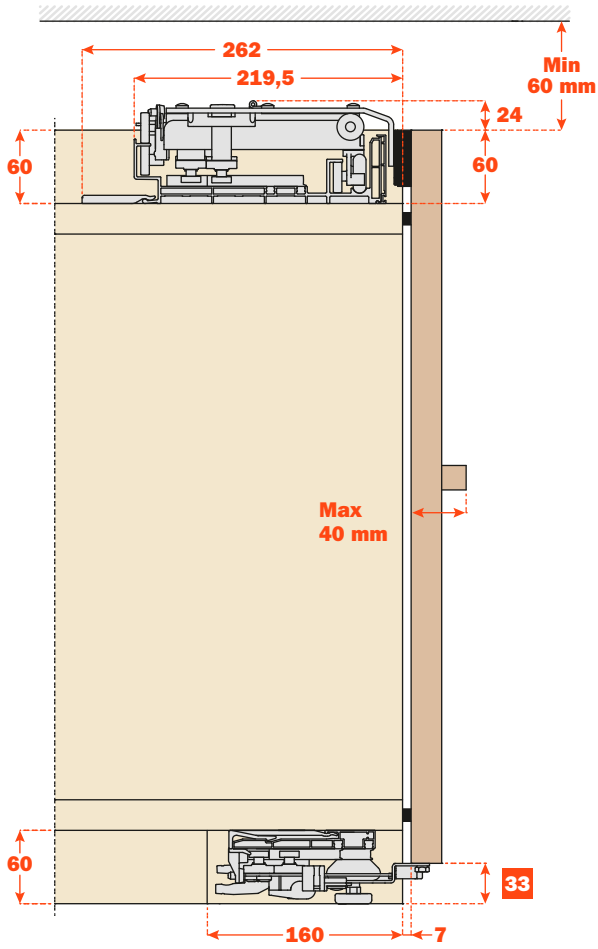

33 (M50)

Recessed adjusters

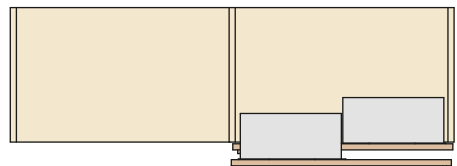
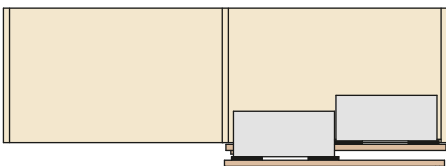
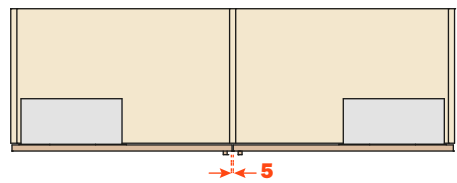
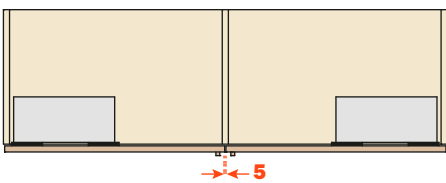
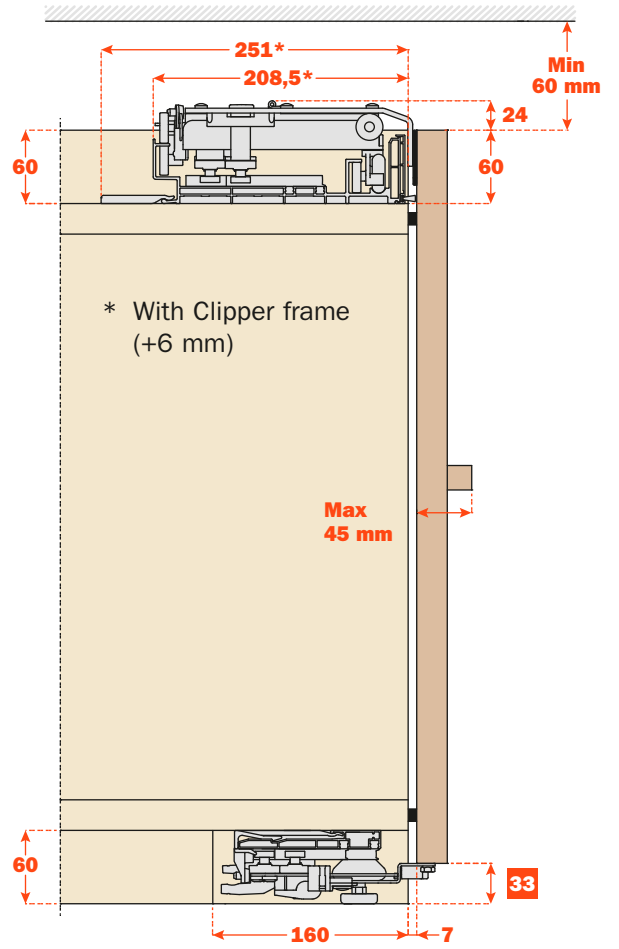

Customised systems

Slider M50 can be supplied in customised lengths i.e. designed for installation on cabinets with internal width (**LI**) equal to the length of the slider rail (**CP**).

Attention: clients can determine the extent to which the door will open based on variable **RAA** (distance between the central panel and edge of the door).

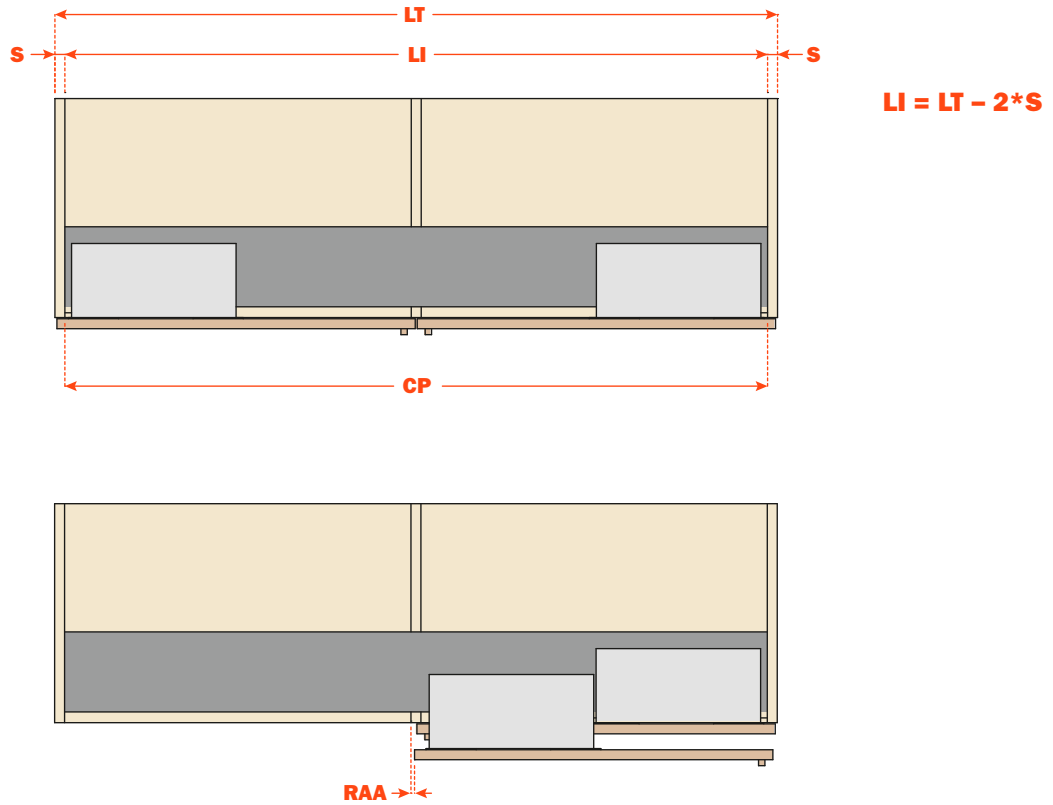

Standard

Slider M50 mechanisms are available in standard lengths i.e. designed for installation on cabinets with internal widths (**LI**) that measure up to 200 mm longer than the slider rail (**CP**) (Fig. **A**).
 Attention: The opening of the doors may be restricted (see formula in fig. **B**).

Fig. **A**

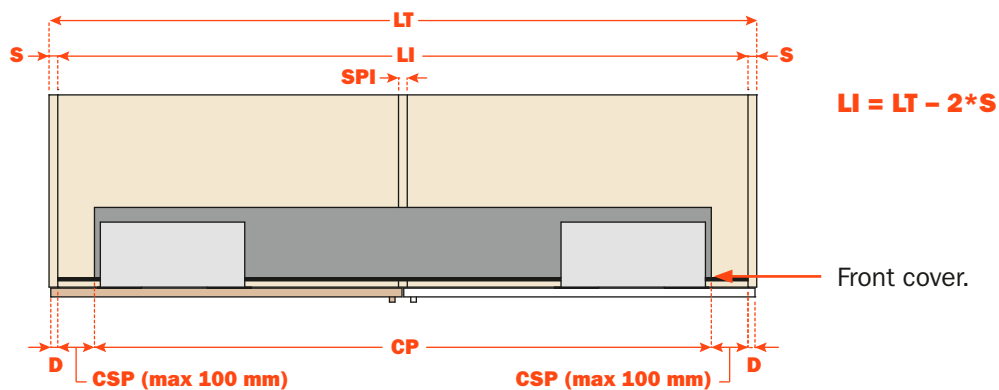
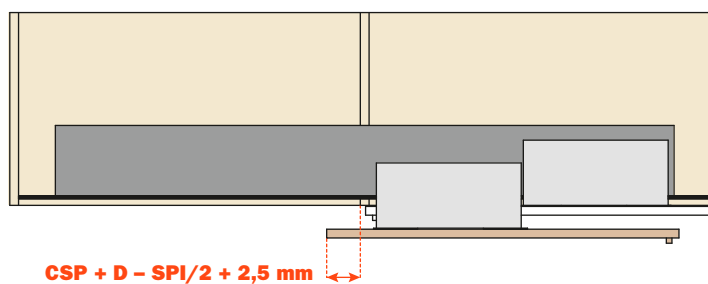
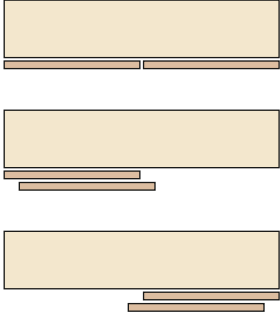

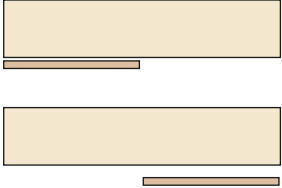

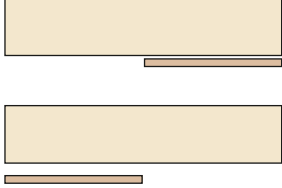

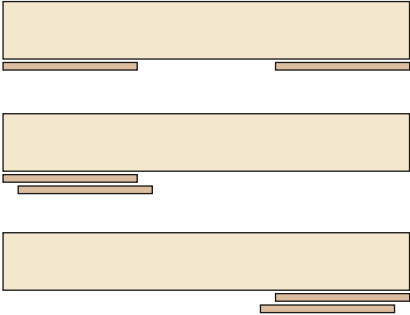

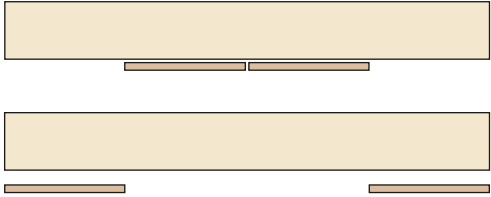



Fig. **B**



Description		Part number	LI (mm)	CP (mm)
Slider M50 2 doors	SM16-18	VE51FB01600NN	1600÷1799	1599
	SM18-20	VE51FB01800NN	1800÷1999	1799
	SM20-22	VE51FB02000NN	2000÷2199	1999
	SM22-24	VE51FB02200NN	2200÷2399	2199
	SM24-26	VE51FB02400NN	2400÷2599	2399
	SM26-28	VE51FB02600NN	2600÷2799	2599
	SM28-30	VE51FB02800NN	2800÷2999	2799
	SM30-32	VE51FB03000NN	3000÷3199	2999
	SM32-34	VE51FB03200NN	3200÷3399	3199
	SM34-36	VE51FB03400NN	3400÷3599	3399
	SM36-38	VE51FB03600NN	3600÷3799	3599
	SM38-40	VE51FB03800NN	3800÷3999	3799

<p>Standard</p>		<p>Slider M35 Slider M50</p>	 <p>Slider M35</p>
<p>One</p>		<p>Slider M35 Slider M50</p>	 <p>Slider M35</p>
<p>One</p>		<p>Slider M35 Slider M50</p>	 <p>Slider M35</p>
<p>Step</p>		<p>Slider M35 Slider M50</p>	 <p>Slider M35</p>
<p>Reverso</p>		<p>Slider M35 Slider M50</p>	 <p>Slider M35</p>

ARTURO SALICE S.p.A.

VIA PROVINCIALE NOVEDRATESE, 10
22060 NOVEDRATE (COMO) ITALIA
TEL. 031 790424
FAX 031 791508
info.salice@salice.com
www.salice.com

BORTOLUZZI SISTEMI S.p.A.

VIA CADUTI 14 SETTEMBRE 1944, 45
32100 BELLUNO ITALIA
TEL. 0437 930866
FAX 0437 931442
info@bortoluzzi.com
www.bortoluzzi.com

DEUTSCHE SALICE GMBH

RUDOLF DIESEL STR. 10
POSTFACH 1154
74382 NECKARWESTHEIM
TEL. 07233 9807-0
FAX. 07233 9807-16
info.salice@deutschesalice.de
www.deutschesalice.de

SALICE UK LTD.

KINGFISHER WAY
HINCHINGBROOKE BUSINESS PARK
HUNTINGDON CAMBS PE 29 6FN
TEL. 01480 413831
FAX. 01480 451489
info.salice@saliceuk.co.uk
www.saliceuk.co.uk

DEUTSCHE SALICE GMBH

VERKAUFSBÜRO NORD
RINGSTRASSE 36/A30 CENTER
32584 LÖHNE
TEL. 05731 15608-0
FAX. 05731 15608-10
vknord@deutschesalice.de
www.deutschesalice.de

SALICE AMERICA INC.

2123 CROWN CENTRE DRIVE
CHARLOTTE NC. 28227
TEL. 704 8417810
FAX. 704 8417808
info.salice@saliceamerica.com
www.saliceamerica.com

SALICE FRANCE S.A.R.L.

ROUTE DE GOA ZAC LES 3 MOULINS
06600 ANTIBES
TEL. 0493 330069
FAX. 0493 330141
info.salice@salicefrance.com
www.salicefrance.com

SALICE CANADA INC.

3500 RIDGEWAY DRIVE,
UNIT#1
MISSISSAUGA, ONTARIO, L5L 0B4
TEL. 905 8208787
FAX. 905 8207226
info.salice@salicecanada.com
www.salicecanada.com

SALICE ESPAÑA, S.L.U.

CALLE COPÉRNICO, 11
POLÍGONO INDUSTRIAL
COLL DE LA MANYA
08403 GRANOLLERS (BARCELONA)
TEL. 938 45 88 61
FAX 938 49 11 97
info.salice@saliceespana.es
www.saliceespana.es

**SALICE CHINA
(SHANGHAI) CO. LTD.**

1st FLOOR, B1 BLDG 928 MINGZHU ROAD
XUJING, QINGPU DISTRICT
SHANGHAI 201702 - CHINA
Tel. 021 3988 9880
Fax 021 3988 9882
info.salice@salicechina.com
www.salicechina.com

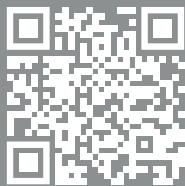
**Digital contents:**

- **Technical pamphlet in Pdf format**

We reserve the right to change technical specifications without notice.

DOCASS011ENG
Ed. 02 - 03/2019

