

TRASER-6

Concealed hangers

INDAUX's TRASER-6 cabinet hanger offers maximum simplicity, adjustment and resistance. Available in a non-tool version.



1 TRASER-6

■ TRASER-6: Rapid fitting



We present the fastest, most convenient and safest fitting system on the market. You won't need any tools to fit your hangers. It won't even take you any time. Fitting Traser 6 is child's play. Try it, you'll be surprised.

> **Maximum problem-free adjustment and precision.**

A Ø18mm hole provides access to all adjustments. Our adjustment screws never penetrate the back of the furniture.

> **Maximum safety.**

Nominal capacity of 55 kgs. per hanger. EN 15939 on A setting.

> **Maximum simplicity.**

By just turning the lever 180°, you will perceive the sensation of safety which our hanger's anchoring system provides.

> **Active safety version**

It is mounted like the standard TRASER-6 hanger and impedes any involuntary removal of top hanging cabinets.

> TRASER-6 active safety version



TRASER-6 rapid active safety version

> **Disassembly**
See end of chapter



TRASER-6 Cabinet hanger, Rapid fitting

	With active security	Standard	
Left	624.215.034	624.200.032	100
Right	624.315.031	624.300.036	



Depth adjustment

Up to 18mm both at the front and back, in this case, without any need to drill the back of the furniture.



Height adjustment

Up to 18mm with a Phillips® No.2, Ø6 screwdriver or a Pozidriv® No.2, Ø6.

> Rear drilling pattern

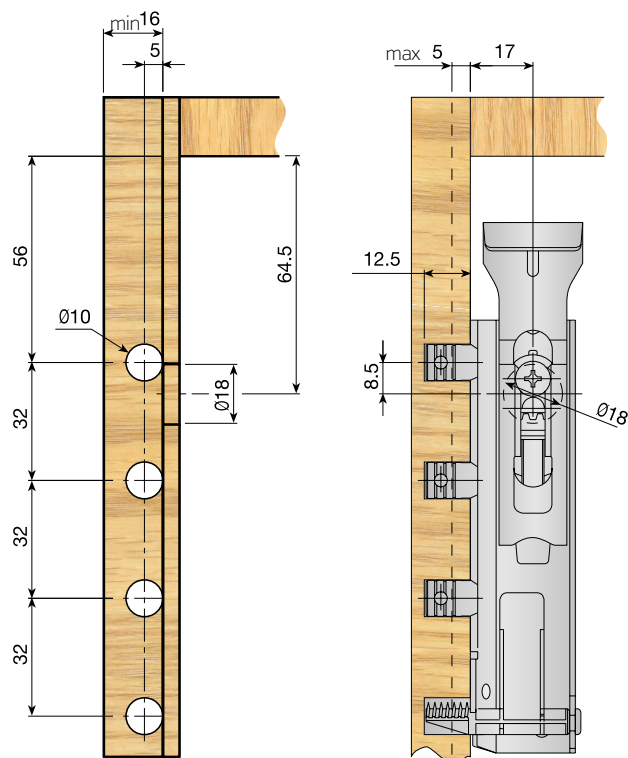

■ TRASER-6: Knock-in fitting



> **Maximum problem-free adjustment and precision.**

A Ø18mm hole provides access to all adjustments. Our adjustment screws never penetrate the back of the furniture.

> **Maximum safety.**

Nominal capacity of 55 kgs. per hanger. EN 15939 on A setting.

The dowels have an additional feature. They have fixing holes for additional screwing. They only need to be used when applying extremely high loads.

> **Maximum simplicity.**

Fixing is done on the side of the cabinet. You just have to screw one 3.5 x 20 screw into the fixing hole.

> **Active safety version**

It is mounted like the standard TRASER-6 hanger and impedes any involuntary removal of top hanging cabinets.

> TRASER-6 active safety version



TRASER-6 knock-in active safety version

> **Disassembly**
See end of chapter



TRASER-6 Cabinet hanger, Knock-in fitting.

	With active security	Standard	
Left	624.015.033	624.000.031	100
Right	624.115.030	624.100.035	



Depth adjustment

Up to 18mm both at the front and back, in this case, without any need to drill the back of the furniture.



Height adjustment

Up to 18mm with a Phillips® No.2, Ø6 screwdriver or a Pozidriv® No.2, Ø6. Both adjustments through the same 18mm diameter hole.

> **Rear drilling pattern**

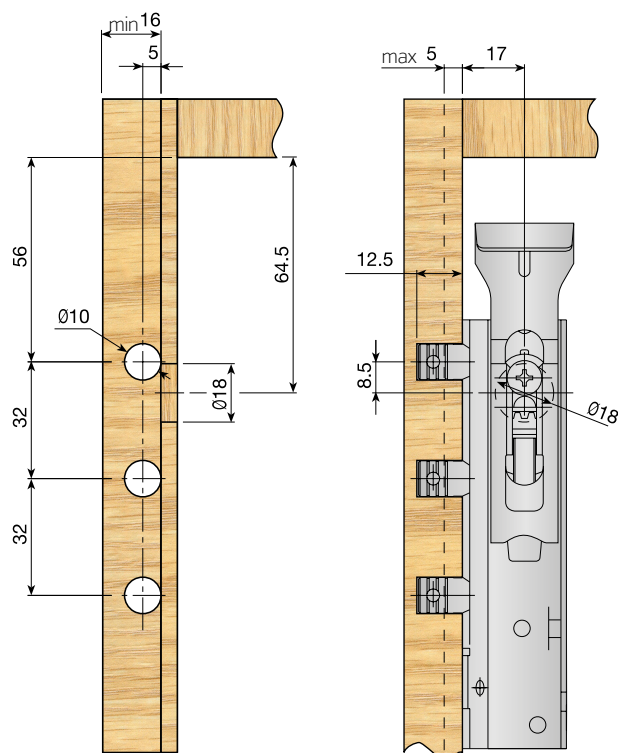

■ TRASER-6: Screw fitting



For those who prefer the traditional fixing system, we present the screw fitting system. The hanger can be fitted on both sides, left or right.

> **Maximum problem-free adjustment and precision.**

A Ø18mm hole provides access to all adjustments. Our adjustment screws never penetrate the back of the furniture.

> **Maximum safety.**

Nominal capacity of 55 kgs. per hanger. EN 15939 on A setting.

> **Maximum simplicity.**

Fixing is done on the side of the cabinet. You just have to screw three 3.5 x 20 screw into the fixing hole.

> **Active safety version**

It is mounted like the standard TRASER-6 hanger and impedes any involuntary removal of top hanging cabinets.

> TRASER-6 active safety version



TRASER-6 screw active safety version

> **Disassembly**

See end of chapter



TRASER-6 Cabinet hanger, Screw fitting.

With active security	Standard	
624.415.035	624.400.033	100



Depth adjustment

Up to 18mm both at the front and back, in this case, without any need to drill the back of the furniture.



Height adjustment

Up to 18mm with a Phillips® No.2, Ø6 screwdriver or a Pozidriv® No.2, Ø6. Both adjustments through the same 18mm diameter hole.

> **Rear drilling pattern**

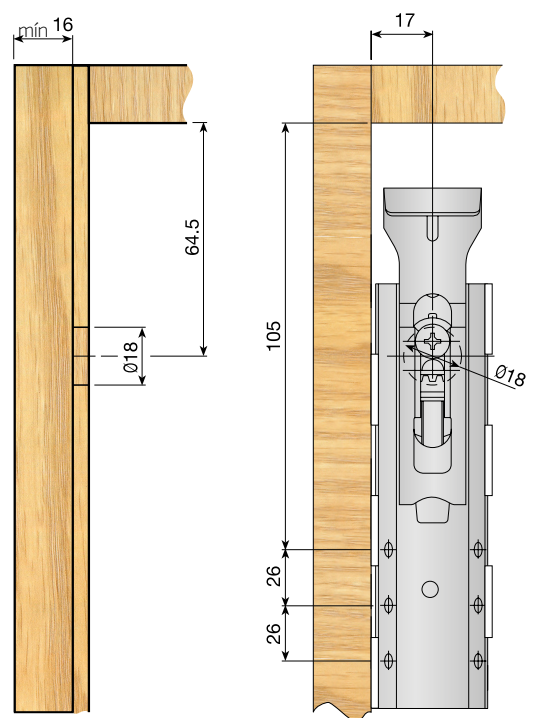

■ TRASER-6: Accessories

Active safety wall mounting plate

			
	623.100.030	100	

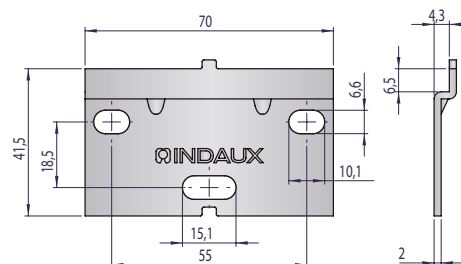

Double wall mounting plate.

Length (mm.)			
130	621.900.031	200	
182	621.901.033	200	

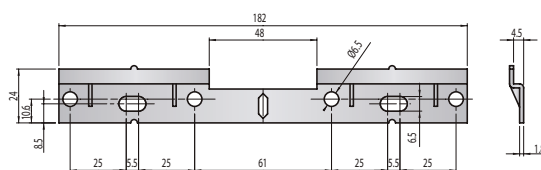
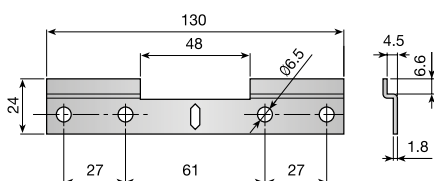

Bag of accessories.

length of wall mounting plate (mm.)			
130	630.800.100	200	
182	630.801.102	200	

Each bag contains 1 wall mounting plate, 4 plastic Ø8X40 plugs and 4 Ø4.5X35 screws.

Oval holes´ double plate

Length (mm.)	Zinc-plated	
130	621.950.033	15

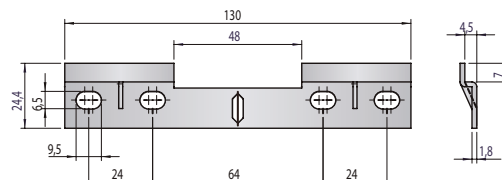

Double wall mounting plate.

Length (mm.)	L	Zinc-plated	
200	158	619.015.036	150
250	208	619.020.032	150
300	258	619.025.035	150
350	308	619.030.031	100
400	358	619.035.034	100
450	408	619.040.030	100
500	458	619.045.033	52
550	508	619.050.036	52
600	558	619.055.032	52
650	608	619.060.035	52
700	658	619.065.031	52
750	708	619.070.034	52
800	758	619.075.030	52
900	858	619.085.036	40
1000	958	619.095.035	40
1200	1158	619.115.033	32
1350	1308	619.130.035	32

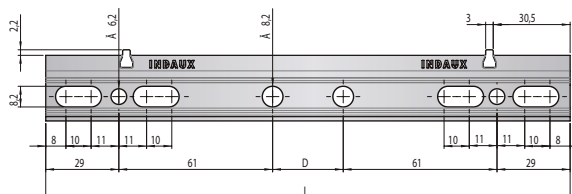
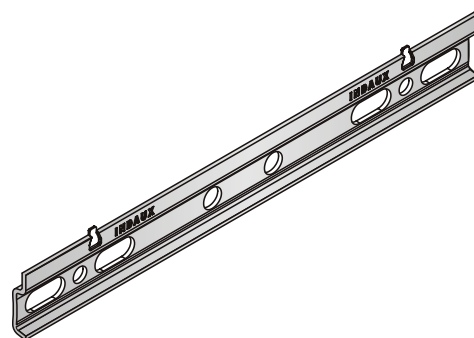

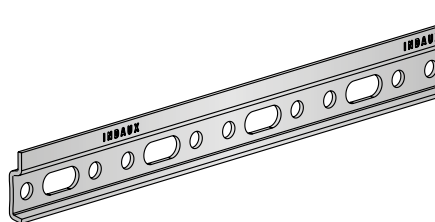
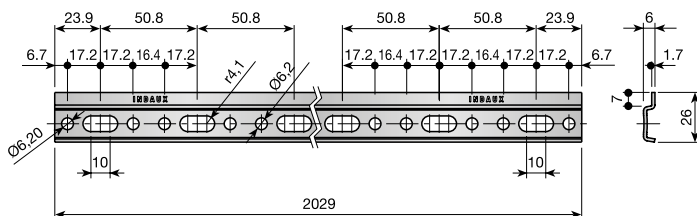

Double wall mounting plate.

Length (mm.)	Zinc-plated	
2029	619.200.035	15



Cover

	Ø25 mm.		Ø18 mm.	
White RAL 9001			961.618.000	1.000
White RAL 9003	530.400.006	2.000		
Nickel	530.400.065	1.000	961.618.066	1.000
Shiny Silver			961.618.501	5.000
Gray RAL 7040	530.400.312	2.000		
AnthraciteRAL 7043			961.618.313	1.000

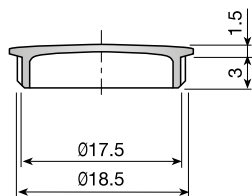

Cover Ø18 mm.

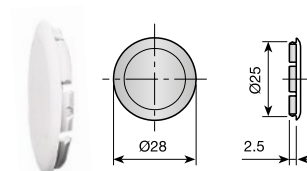

Cover Ø25 mm.

Disassembly Traser 6 with active safety



To unlock the active safety feature, set both adjustments to the maximum as shown in the images.

