



BALDES DE LIXO

CASATREND | HAILO

CARGO SYNCHRO

Abertura automática.

Corrediças cobertas, sincronizadas e soft-close.

Montado na ilharga, ajustável para 16-19 mm.

Prateleira de metal/plástico de puxar com tapete anti-derrapante de borracha.

300	30 L	
450	55 L	18 + 18 L
500	28 + 18 L	18 + 13 + 13 L
600	28 + 28 L	28 + 13 + 13 L

Cargo Synchro 300 30L

Abertura automática.

Corrediças cobertas, sincronizadas e soft-close.

Montado na ilharga, ajustável para 16-19 mm.

Prateleira de metal/plástico de puxar, com tapete anti-derrapante de borracha.

Volume de 30L (balde único).

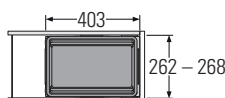
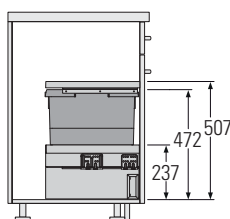

Mód.	L (mm)	P (mm)	A (mm)	V (L)	Acab.	Código
30	262-268	403	507	30	Cinza escuro	H.CS3608311



Cargo Synchro 450 55L

Abertura automática.

Corrediças cobertas, sincronizadas e soft-close.

Montado na ilharga, ajustável para 16-19 mm.

Prateleira de metal/plástico de puxar, com tapete anti-derrapante de borracha.

Volume de 55L (balde único).

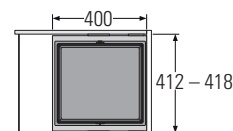
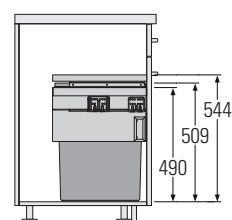

Mód.	L (mm)	P (mm)	A (mm)	V (L)	Acab.	Código
45	412-418	400	544	55	Cinza escuro	H.CS3608461

Cargo Synchro 450 18+18L

Abertura automática.

Corrediças cobertas, sincronizadas e soft-close.

Montado na ilharga, ajustável para 16-19 mm.

Prateleira de metal/plástico de puxar, com tapete anti-derrapante de borracha.

Volume de 36L (18L + 18L).

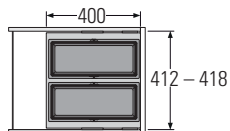
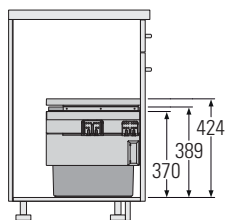

Mód.



L (mm)



P (mm)



A (mm)



V (L)



Acab.

Código

45

412-418

400

424

36

Cinza escuro

H.CS3608471



Cargo Synchro 500 28+18L

Abertura automática.

Corrediças cobertas, sincronizadas e soft-close.

Montado na ilharga, ajustável para 16-19 mm.

Prateleira de metal/plástico de puxar, com tapete anti-derrapante de borracha.

Volume de 46L (28L + 18L).

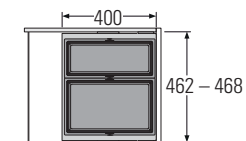
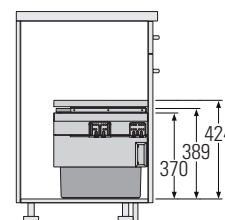

Mód.



L (mm)



P (mm)



A (mm)



V (L)



Acab.

Código

50

462-468

400

424

46

Cinza escuro

H.CS3608521

Cargo Synchro 500 18+13+13L D

Abertura automática.

Corrediças cobertas, sincronizadas e soft-close.

Montado na ilharga, ajustável para 16-19 mm.

Prateleira de metal/plástico de puxar, com tapete anti-derrapante de borracha.

1 tampa de balde.

Volume de 44L (18L + 13L + 13L).

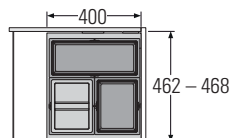
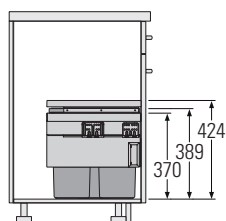

Mód.



L (mm)



P (mm)



A (mm)



V (L)



Acab.

Código

50

462-468

400

424

44

Cinza escuro

H.CS3608531



Cargo Synchro 600 28+28L

Abertura automática.
 Corrediças cobertas, sincronizadas e soft-close.
 Montado na ilharga, ajustável para 16-19 mm.
 Prateleira de metal/plástico de puxar, com tapete anti-derrapante de borracha.
 Volume de 56L (28L + 28L).

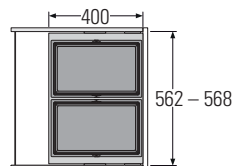
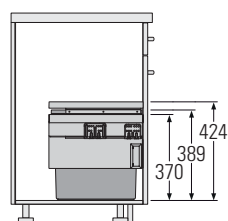

Mód.	L (mm)	P (mm)	A (mm)	V (L)	Acab.	Código
60	562-568	400	424	56	Cinza escuro	H.CS3608621

Cargo Synchro 600 28+13+13L D

Abertura automática.
 Corrediças cobertas, sincronizadas e soft-close.
 Montado na ilharga, ajustável para 16-19 mm.
 Prateleira de metal/plástico de puxar, com tapete anti-derrapante de borracha.
 1 tampa para balde de 13L.
 Volume de 54L (28L + 13L + 13L).

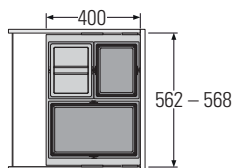
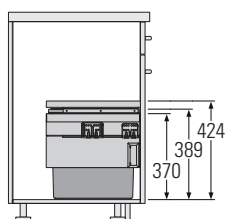

Mód.	L (mm)	P (mm)	A (mm)	V (L)	Acab.	Código
60	562-568	400	424	54	Cinza escuro	H.CS3608631

EURO CARGO

Abertura automática.
Corrediças cobertas, sincronizadas e soft-close.
Montado na ilharga, ajustável para 16-19 mm.
Prateleira de chapa metálica.

400	38 + 17 L
450	38 + 38 L
500	38 + 38 L
600	38 + 38 + 12 + 2,5 L

Euro Cargo 400 38+7L

Abertura automática.
Corrediças cobertas, sincronizadas e soft-close.
Montado na ilharga, ajustável para 16-19 mm.
Prateleira de chapa metálica.
Volume de 45L (38L + 7L).

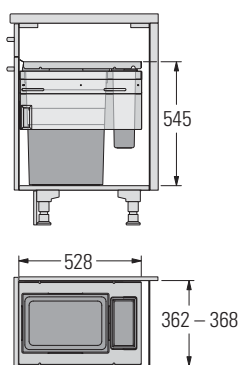

Mód.	L (mm)	P (mm)	A (mm)	V (L)	Acab.	Código
40	362-368	528	545	45	Cinza claro	H.EC3619421



Euro Cargo 450 38+38L

Abertura automática.
Corrediças cobertas, sincronizadas e soft-close.
Montado na ilharga, ajustável para 16-19 mm.
Prateleira de chapa metálica.
Volume de 76L (38L + 38L).

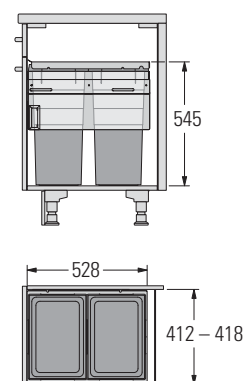

Mód.	L (mm)	P (mm)	A (mm)	V (L)	Acab.	Código
45	412-418	528	545	76	Cinza claro	H.EC3619471
45	412-418	528	545	76	Cinza escuro	H.EC3619731



AS Euro Cargo 450 35+35L

Abertura automática.
Corrediças cobertas, sincronizadas e soft-close.
Montado na ilharga, ajustável para 16-19 mm.
Prateleira de chapa metálica.
Volume de 70L (35L + 35L).

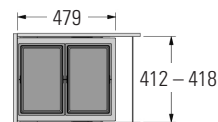
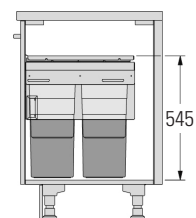

Mód.	L (mm)	P (mm)	A (mm)	V (L)	Acab.	Código
45	412-418	479	545	70	Cinza escuro	H.EC3619821

Euro Cargo 500 38+38L

Abertura automática.
Corrediças cobertas, sincronizadas e soft-close.
Montado na ilharga, ajustável para 16-19 mm.
Prateleira de chapa metálica.
Volume de 76L (38L + 38L).

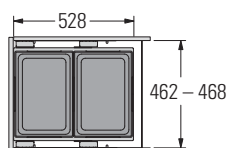
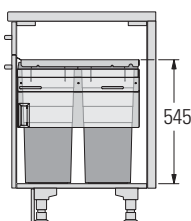

Mód.	L (mm)	P (mm)	A (mm)	V (L)	Acab.	Código
50	462-468	528	545	76	Cinza claro	H.EC3619531
50	462-468	528	545	76	Cinza escuro	H.EC3619721



AS Euro Cargo 500 35+35L

Abertura automática.
Corrediças cobertas, sincronizadas e soft-close.
Montado na ilharga, ajustável para 16-19 mm.
Prateleira de chapa metálica.
Volume de 70L (35L + 35L).

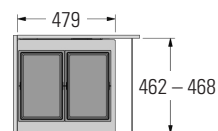
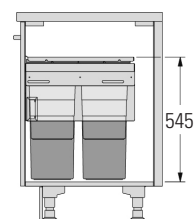

Mód.	L (mm)	P (mm)	A (mm)	V (L)	Acab.	Código
50	462-468	479	545	70	Cinza escuro	H.EC3619831

Euro Cargo 600 38+38+12+2,5L D

Abertura automática.
Corrediças cobertas, sincronizadas e soft-close.
Montado na ilharga, ajustável para 16-19 mm.
Prateleira de chapa metálica.
1 tampa de balde de 12L.
Volume de 90,5L (38L + 38L + 12L + 2,5L).

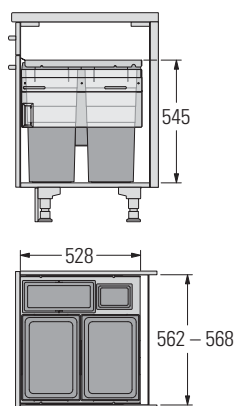

M	L (mm)	P (mm)	A (mm)	V (L)	Acab.	Código
60	562-568	528	545	90,5	Cinza claro	H.EC3619621
60	562-568	528	545	90,5	Cinza escuro	H.EC3619771



AS Euro Cargo 600 35+35+10+10L

Abertura automática.
Corrediças cobertas, sincronizadas e soft-close.
Montado na ilharga, ajustável para 16-19 mm.
Prateleira de chapa metálica.
Volume de 90L (35L + 35L + 10L + 10L).

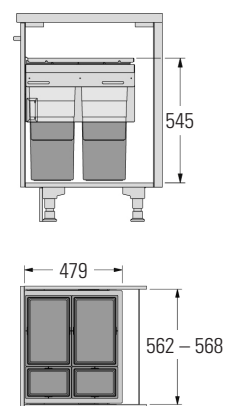

M	L (mm)	P (mm)	A (mm)	V (L)	Acab.	Código
60	562-568	479	545	90	Cinza escuro	H.EC3619841

AS CARGO

Abertura automática.

Corrediças cobertas soft-close.

Montado na ilharga, ajustável para 16-19 mm.

Prateleira de chapa metálica.

300	15 + 10 L			
450	14 + 14 L		21 + 17 L	
500	20 + 14 L	17 + 13 + 13 L	28 + 17 L	
600	20 + 10 + 10 L	28 + 13 + 13 L	28 + 28 L	13 + 13 + 13 + 13 L

Cargo Soft Short 450 14+14L

Abertura automática.

Corrediças cobertas soft-close.

Montado na ilharga, ajustável para 16-19 mm.

Prateleira de chapa metálica.

Volume de 28L (14L + 14L).



Compatível com mecanismo Libero

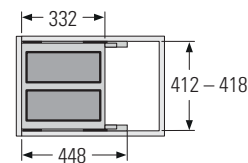
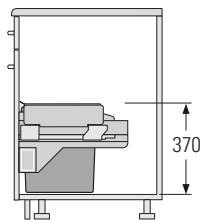

Mód.



L (mm)



P (mm)



A (mm)



V (L)



Acab.

Código

45	412-418	332/448	370	28	Cinza	H.SS3610481
----	---------	---------	-----	----	-------	-------------



Cargo Soft Short 500 20+14L

Abertura automática.

Corrediças cobertas soft-close.

Montado na ilharga, ajustável para 16-19 mm.

Prateleira de chapa metálica.

Volume de 34L (20L + 14L).



Compatível com mecanismo Libero

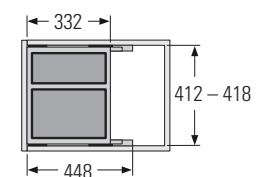
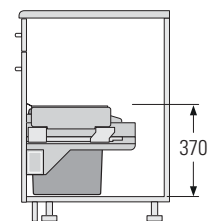

Mód.



L (mm)



P (mm)



A (mm)



V (L)



Acab.

Código

50	462-468	332/448	370	34	Cinza	H.SS3610581
----	---------	---------	-----	----	-------	-------------

Cargo Soft Short 600 20+10+10L D

Abertura automática.
Corrediças cobertas soft-close.
Montado na ilharga, ajustável para 16-19 mm.
Prateleira de chapa metálica.
1 tampa para balde de 10L.
Volume de 40L (20L + 10L + 10L).



Compatível com mecanismo Libero



Mód.

60



L (mm)

562-568



P (mm)

332/448



A (mm)

370



V (L)

40



Acab.

Cinza

Código

H.SS3610681

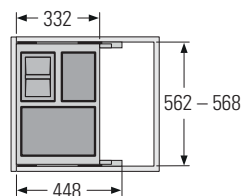
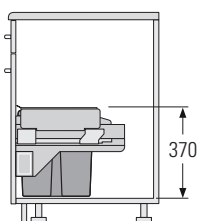

AS Cargo 300 15+10L D

Abertura automática.
Corrediças cobertas, sincronizadas e soft-close.
Montado na ilharga, ajustável para 16-19 mm.
Prateleira de chapa metálica.
1 tampa para balde de 10L.
Volume de 25L (15L + 10L)

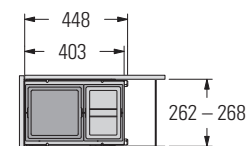
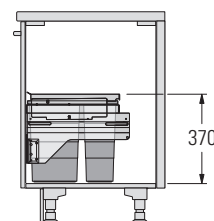

Mód.

30



L (mm)

262-268



P (mm)

403/448



A (mm)

388



V (L)

25



Acab.

Cinza escuro

Código

H.AS3610871

AS Cargo 450 21+17L

Abertura automática.
Corrediças cobertas, sincronizadas e soft-close.
Montado na ilharga, ajustável para 16-19 mm.
Prateleira de chapa metálica.
Volume de 38L (21L + 17L)

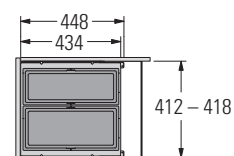
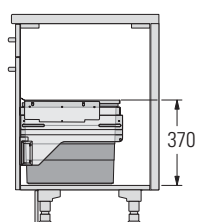

Mód.

45



L (mm)

412-418



P (mm)

434/448



A (mm)

370



V (L)

38



Acab.

Cinza escuro

Código

H.AS3610811



AS Cargo 500 28+17L

Abertura automática.
Corrediças cobertas, sincronizadas e soft-close.
Montado na ilharga, ajustável para 16-19 mm.
Prateleira de chapa metálica.
Volume de 45L (28L + 17L)

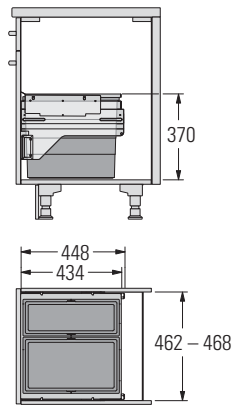

Mód.	L (mm)	P (mm)	A (mm)	V (L)	Acab.	Código
50	462-468	434/448	370	45	Cinza escuro	H.AS3610821



AS Cargo 500 17+13+13L D

Abertura automática.
Corrediças cobertas, sincronizadas e soft-close.
Montado na ilharga, ajustável para 16-19 mm.
Prateleira de chapa metálica.
1 tampa para balde de 13L.
Volume de 43L (17L + 2 x 13L).

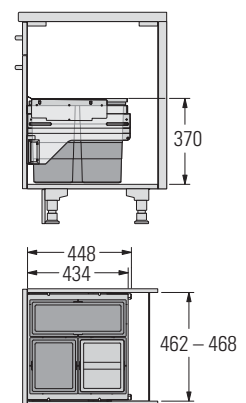

Mód.	L (mm)	P (mm)	A (mm)	V (L)	Acab.	Código
50	462-468	434/448	370	43	Cinza escuro	H.AS3610831

AS Cargo 600 28+13+13L D

Abertura automática.
Corrediças cobertas, sincronizadas e soft-close.
Montado na ilharga, ajustável para 16-19 mm.
Prateleira de chapa metálica.
1 tampa para balde de 13L.
Volume de 54L (28L + 2 x 13L).

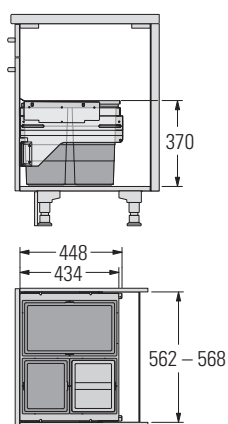

Mód.	L (mm)	P (mm)	A (mm)	V (L)	Acab.	Código
60	562-568	434/448	370	54	Cinza escuro	H.AS3610851



AS Cargo 600 28+28L

Abertura automática.
Corrediças cobertas, sincronizadas e soft-close.
Montado na ilharga, ajustável para 16-19 mm.
Prateleira de chapa metálica.
Volume de 56L (2 x 28L).

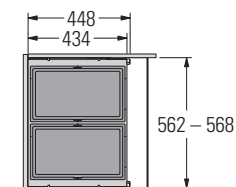
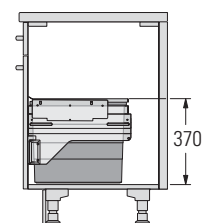

Mód.	L (mm)	P (mm)	A (mm)	V (L)	Acab.	Código
60	562-568	434/448	370	56	Cinza escuro	H.AS3610841

AS Cargo 600 13+13+13+13L D

Abertura automática.
Corrediças cobertas, sincronizadas e soft-close.
Montado na ilharga, ajustável para 16-19 mm.
Prateleira de chapa metálica.
1 tampa de balde de 13L.
Volume de 52L (13L x 4)

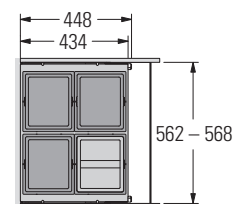
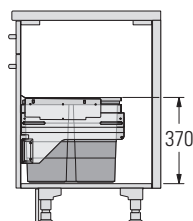

Mód.	L (mm)	P (mm)	A (mm)	V (L)	Acab.	Código
60	562-568	434/448	370	52	Cinza escuro	H.AS3610861



AS EURO CARGO

Abertura automática.

Corrediças cobertas soft-close.

Montado na ilharga, ajustável para 16-19 mm.

Prateleira de chapa metálica.

300 30 L

450 19 + 19 L

500 30 + 19 L

600 30 + 30 L 30 + 13 + 13 L

AS Euro Cargo S 300 30L

Abertura automática.

Corrediças cobertas soft-close.

Montado na ilharga, ajustável para 16-19 mm.

Prateleira de chapa metálica.

Volume de 30L (balde único).



Compatível com mecanismo Libero

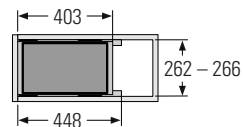
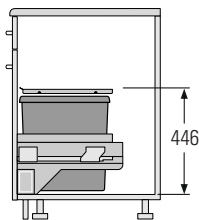

Mód. L (mm) P (mm) A (mm) V (L) Acab. Código

30 262-268 403/448 446 30 Cinza H.EC3610121



AS Euro Cargo S 450 19+19L

Abertura automática.

Corrediças cobertas soft-close.

Montado na ilharga, ajustável para 16-19 mm.

Prateleira de chapa metálica.

Volume de 38L (19L + 19L).



Compatível com mecanismo Libero

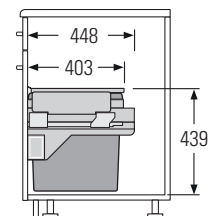

Mód. L (mm) P (mm) A (mm) V (L) Acab. Código

45 412-418 403/448 439 38 Cinza H.EC3610471



AS Euro Cargo S 500 30+19L

Abertura automática.
Corrediças cobertas soft-close.
Montado na ilharga, ajustável para 16-19 mm.
Prateleira de chapa metálica.
Volume de 49L (30L + 19L).

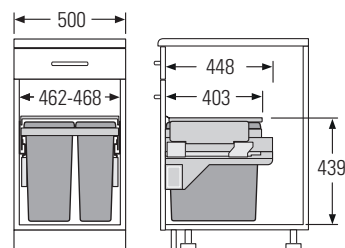

Compatível com mecanismo Libero

Mód.	L (mm)	P (mm)	A (mm)	V (L)	Acab.	Código
50	462-468	403/448	439	49	Cinza	H.EC3610521

AS Euro Cargo S 600 30+30L

Abertura automática.
Corrediças cobertas, sincronizadas e soft-close.
Montado na ilharga, ajustável para 16-19 mm.
Prateleira de chapa metálica.
Volume de 60L (30L + 30L)

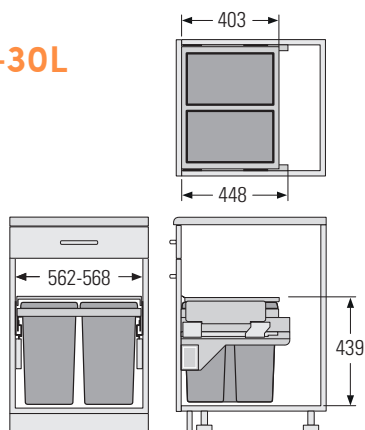

Mód.	L (mm)	P (mm)	A (mm)	V (L)	Acab.	Código
60	562-568	403/448	439	60	Cinza	H.AS3610621



AS Euro Cargo S 600 30+13+13L D

Abertura automática.
Corrediças cobertas soft-close.
Montado na ilharga, ajustável para 16-19 mm.
Prateleira de chapa metálica.
Volume de 56L (30L + 13L + 13L).

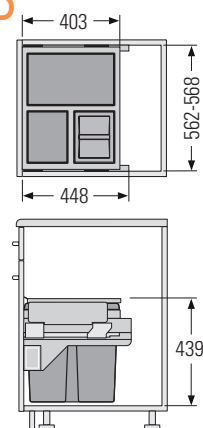

Compatível com mecanismo Libero

Mód.	L (mm)	P (mm)	A (mm)	V (L)	Acab.	Código
60	562-568	403/448	439	56	Cinza	H.AS3610631

TRIPLE XL

Abertura automática.

Instalado no fundo de qualquer gaveta standard (gaveta não fornecida).

Ajustável a ilhargas de 16-19 mm.

Laterais do balde cobrem as corrediças da gaveta. Não fornecidas.

Prateleira de chapa metálica montada na ilharga.

450	55 L	18 + 18 L
500	28 + 18 L	18 + 13 + 13 L
600	28 + 28 L	28 + 13 + 13 L
800	28 + 28 + 18 L	
900	28 + 28 + 28 L	

Triple XL 450 55L

Abertura automática.

Instalado no fundo de qualquer gaveta standard.

Ajustável a ilhargas de 16-19 mm.

Laterais do balde cobrem as corrediças da gaveta.

Prateleira de chapa metálica montada na ilharga.

Profundidade mínima da gaveta: 420 mm.

Volume de 55L (balde único).



Compatível com mecanismo Libero

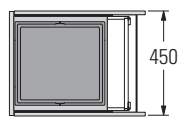
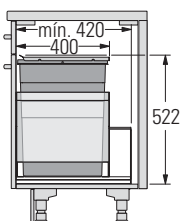

Mód.



P (mm)



A (mm)



V (L)



Acab.

Código

45	400/420	522	55	Cinza escuro	H.TX3631481
----	---------	-----	----	--------------	-------------

Triple XL 450 18+18L

Abertura automática.

Instalado no fundo de qualquer gaveta standard.

Ajustável a ilhargas de 16-19 mm.

Laterais do balde cobrem as corrediças da gaveta.

Prateleira de chapa metálica montada na ilharga.

Profundidade mínima da gaveta: 420 mm.

Volume de 36L (2 x 18L).



Compatível com mecanismo Libero

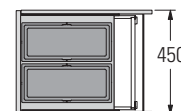
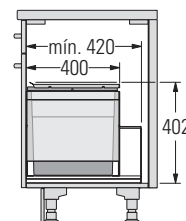

Mód.



P (mm)



A (mm)



V (L)



Acab.

Código

45	400/420	402	36	Cinza escuro	H.TX3631491
----	---------	-----	----	--------------	-------------

Triple XL 500 28+18L

Abertura automática.

Instalado no fundo de qualquer gaveta standard.

Ajustável a ilhargas de 16-19 mm.

Laterais do balde cobrem as corrediças da gaveta.

Prateleira de chapa metálica montada na ilharga.

Profundidade mínima da gaveta: 420 mm.

Volume de 46L (28L + 18L).



Compatível com mecanismo Libero



Mód.



P (mm)



A (mm)



V (L)



Acab.

Código

50

400/420

402

46

Cinza escuro

H.TX3631581

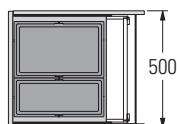
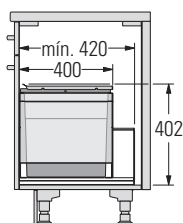

Triple XL 500 18+13+13 D

Abertura automática.

Instalado no fundo de qualquer gaveta standard.

Ajustável a ilhargas de 16-19 mm.

Laterais do balde cobrem as corrediças da gaveta.

Prateleira de chapa metálica montada na ilharga.

Profundidade mínima da gaveta: 420 mm.

Volume de 44L (18L + 2 x 13L).



Compatível com mecanismo Libero



Mód.



P (mm)



A (mm)



V (L)



Acab.

Código

50

400/420

402

44

Cinza escuro

H.TX3631591

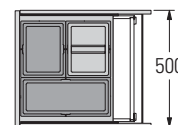
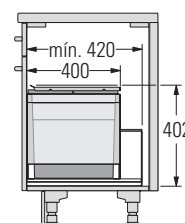

Triple XL 600 28+28L

Abertura automática.

Instalado no fundo de qualquer gaveta standard.

Ajustável a ilhargas de 16-19 mm.

Laterais do balde cobrem as corrediças da gaveta.

Prateleira de chapa metálica montada na ilharga.

Profundidade mínima da gaveta: 420 mm.

Volume de 56L (2 x 28L).



Compatível com mecanismo Libero



Mód.



P (mm)



A (mm)



V (L)



Acab.

Código

60

400/420

402

56

Cinza escuro

H.TX3631681

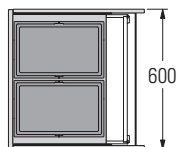
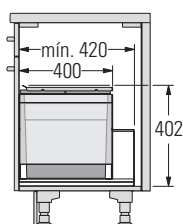



Triple XL 600 28+13+13L D

Abertura automática.
 Instalado no fundo de qualquer gaveta standard.
 Ajustável a ilhargas de 16-19 mm.
 Laterais do balde cobrem as corrediças da gaveta.
 Prateleira de chapa metálica montada na ilharga.
 Profundidade mínima da gaveta: 420 mm.
 Volume de 54L (28L + 2 x 13L).

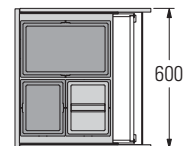
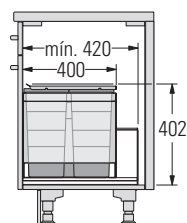

Compatível com mecanismo Libero



Mód.



P (mm)



A (mm)



V (L)



Acab.

Código

60

400/420

402

54

Cinza escuro

H.TX3631691

Triple XL 800 28+28+18L

Abertura automática.
 Instalado no fundo de qualquer gaveta standard.
 Ajustável a ilhargas de 16-19 mm.
 Laterais do balde cobrem as corrediças da gaveta.
 Prateleira de chapa metálica montada na ilharga.
 Profundidade mínima da gaveta: 420 mm.
 Volume de 74L (2 x 28L + 18L).



Compatível com mecanismo Libero



Mód.



P (mm)



A (mm)



V (L)



Acab.

Código

80

400/420

402

74

Cinza escuro

H.TX3631881

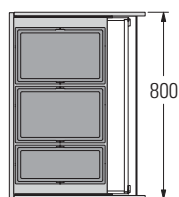
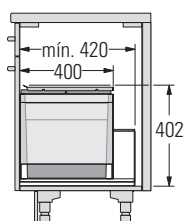

Triple XL 900 28+28+28L

Abertura automática.
 Instalado no fundo de qualquer gaveta standard.
 Ajustável a ilhargas de 16-19 mm.
 Laterais do balde cobrem as corrediças da gaveta.
 Prateleira de chapa metálica montada na ilharga.
 Profundidade mínima da gaveta: 420 mm.
 Volume de 84L (3 x 28L).



Compatível com mecanismo Libero



Mód.



P (mm)



A (mm)



V (L)



Acab.

Código

90

400/420

402

84

Cinza escuro

H.TX3631981

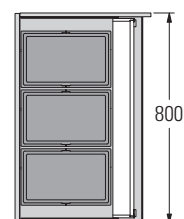
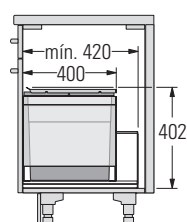

AS XXL

Abertura automática.

Instalado no fundo de qualquer gaveta standard (gaveta não fornecida).

Ajustável a ilhargas de 16-19 mm.

Com depósito(s) para utensílios e/ou cesto(s) para artigos de limpeza.

Tampa para balde de 18L.

450	18 + 12 L
500	12 + 8,5 + 8,5 L
600	18 + 8,5 + 8,5 L
800	18 + 18 + 12 L
900	18 + 18 + 12 + 12 L

AS XXL 450 18+12L D+P+U

Abertura automática.

Instalado no fundo de qualquer gaveta standard.

Ajustável a ilhargas de 16-19 mm.

Com 1 depósito para utensílios de 0,7L e 1 cesto para artigos de limpeza de 4,1L.

Com tampa para o balde de 18L.

Profundidade mínima da gaveta: 500 mm.

Volume de 30L (18L + 12L).



Compatível com mecanismo Libero

Mód.	P (mm)	A (mm)	V (L)	Acab.	Código
45	433	330	30	Cinza	H.XL3630451

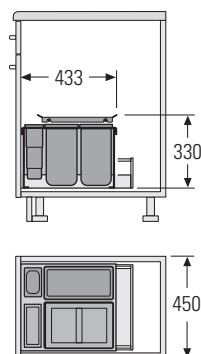

AS XXL 500 12+8,5+8,5L D+2P

Abertura automática.

Instalado no fundo de qualquer gaveta standard.

Ajustável a ilhargas de 16-19 mm.

Com 2 cestos para artigos de limpeza de 4,1L cada.

Com tampa para o balde de 12L.

Profundidade mínima da gaveta: 500 mm.

Volume de 29L (12L + 8,5L + 8,5L).



Compatível com mecanismo Libero

Mód.	P (mm)	A (mm)	V (L)	Acab.	Código
50	433	330	29	Cinza	H.XL3630501

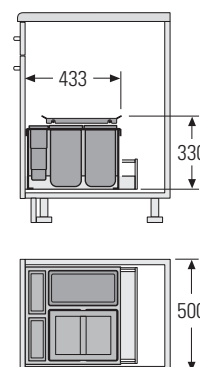

AS XXL 600 18+8,5+8,5L D+2P

Abertura automática.

Instalado no fundo de qualquer gaveta standard.

Ajustável a ilhargas de 16-19 mm.

Com 2 cestos para artigos de limpeza de 4,1L cada.

Com tampa para o balde de 18L.

Profundidade mínima da gaveta: 500 mm.

Volume de 35L (18L + 8,5L + 8,5L).



Compatível com mecanismo Libero

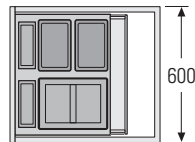
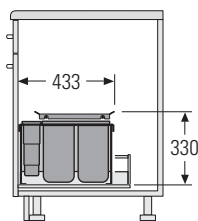

Mód. P (mm) A (mm) V (L) Acab. Código

60 433 330 35 Cinza H.XL3630601



AS XXL 800 18+18+12L 2D+2P

Abertura automática.

Instalado no fundo de qualquer gaveta standard.

Ajustável a ilhargas de 16-19 mm.

Com 3 cestos para artigos de limpeza de 4,1L cada.

Com tampas para os baldes de 18L.

Profundidade mínima da gaveta: 500 mm.

Volume de 48L (18L + 18L + 12L).



Compatível com mecanismo Libero

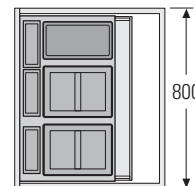
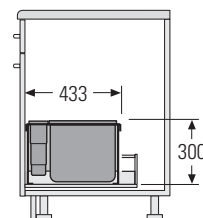

Mód. P (mm) A (mm) V (L) Acab. Código

80 433 300 48 Cinza H.XL3630801

AS XXL 900 18+18+12+12L 2D+2P+2U

Abertura automática.

Instalado no fundo de qualquer gaveta standard.

Ajustável a ilhargas de 16-19 mm.

Com 2 depósitos para utensílios de 0,7L cada e 2 cestos para artigos de limpeza de 4,1L cada.

Com tampas para os baldes de 18L.

Profundidade mínima da gaveta: 500 mm.

Volume de 60L (18L + 18L + 12L + 12L).



Compatível com mecanismo Libero

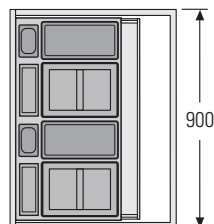
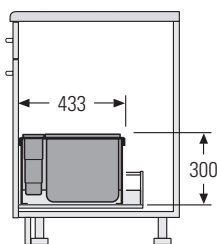

Mód. P (mm) A (mm) V (L) Acab. Código

90 433 300 60 Cinza H.XL3630901

CARGO SEPARATO

Abertura automática.

Para aplicação em gavetão médio ou alto (gavetão não fornecido).

Não compatível com Blum Legra Box F.

Prateleira de plástico de extensão única.

Tampa para balde de 8L.

450	18 + 8 + 8 L	
500	18 + 8 + 8 L	
600	18 + 8 + 8 L	20 + 20 L
800	18 + 18 + 8 + 8 L	

Cargo Separato K 450 18+8+8L D

Abertura automática.

Para aplicação em gavetão médio ou alto.

Não compatível com Blum Legra Box F.

Prateleira de plástico de extensão única.

1 tampa de balde de 8L.

Volume de 34L (18L + 8L + 8L).



Compatível com mecanismo Libero



Mód.



L (mm)



P (mm)



A (mm)



V (L)



Acab.

Código

45	407	491	340	34	Cinza	H.SK3620461
----	-----	-----	-----	----	-------	-------------

45	407	491	340	34	Cinza escuro	H.SK3620471
----	-----	-----	-----	----	--------------	-------------

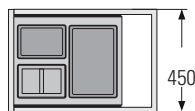
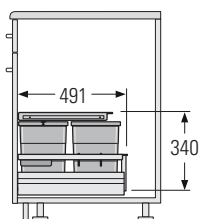

Cargo Separato K 500 18+8+8L D

Abertura automática.

Para aplicação em gavetão médio ou alto.

Não compatível com Blum Legra Box F.

Prateleira de plástico de extensão única.

1 tampa de balde de 8L.

Volume de 34L (18L + 8L + 8L).



Compatível com mecanismo Libero



Mód.



L (mm)



P (mm)



A (mm)



V (L)



Acab.

Código

50	457	491	340	34	Cinza	H.SK3620511
----	-----	-----	-----	----	-------	-------------

50	457	491	340	34	Cinza escuro	H.SK3620521
----	-----	-----	-----	----	--------------	-------------

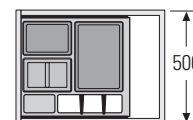
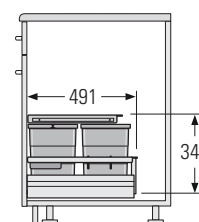

Cargo Separato K 600 18+8+8L D

Abertura automática.

Para aplicação em gavetão médio ou alto.

Não compatível com Blum Legra Box F.

Prateleira de plástico de extensão única.

1 tampa de balde de 8L.

Volume de 34L (18L + 8L + 8L).

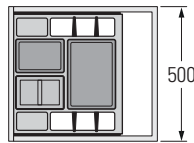
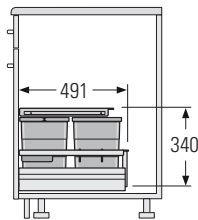

 Compatível com mecanismo Libero

Mód.	L (mm)	P (mm)	A (mm)	V (L)	Acab.	Código
60	557	491	340	34	Cinza	H.SK3620611
60	557	491	340	34	Cinza escuro	H.SK3620651



Cargo Separato K 600 20+20L

Abertura automática.

Para aplicação em gavetão médio ou alto.

Não compatível com Blum Legra Box F.

Prateleira de plástico de extensão única.

Volume de 40L (20L + 20L).

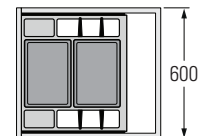
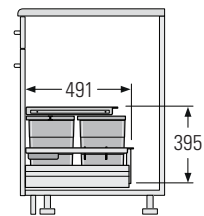

 Compatível com mecanismo Libero

Mód.	L (mm)	P (mm)	A (mm)	V (L)	Acab.	Código
60	557	491	395	40	Cinza	H.SK3620801
60	557	491	395	40	Cinza escuro	H.SK3620811

Cargo Separato K 900 18+18+8+8L D KS

Abertura automática.

Para aplicação em gavetão médio ou alto.

Não compatível com Blum Legra Box F.

Prateleira de plástico.

1 tampa de balde de 8L.

Inclui escova e pá de pó.

Volume de 52L (18L + 18L + 8L + 8L).

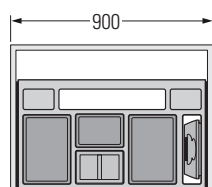
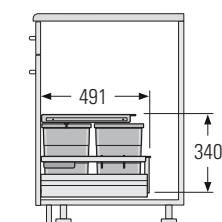

Mód.	L (mm)	P (mm)	A (mm)	V (L)	Acab.	Código
90	860	491	340	52	Cinza	H.SK3620911

Compatível com mecanismo Libero



TANDEM

Modelos de extração total, outros parcial.
Instalado no fundo do móvel.

300	15 + 15 L	24 + 7 L	24 L
400	15 + 15 L	18 + 18 L	20 + 20 L
500	18 + 12 L		

Tandem 15+15L (3666)

Extração total.

Montagem no fundo do móvel.

Volume de 30L (15L + 15L).

Modelos incluem acessórios diferentes:

- Mód. 30 inclui tampa para um balde.
- Mód. 40 inclui escova e apanhador.

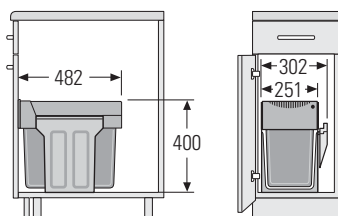

M	L (mm)	P (mm)	A (mm)	V (L)	Acab.	Código
30	251	482	400	30	Cinza	H.T3666821
40	302	482	400	30	Cinza	H.T3666801



Tandem 24+7L / 15+15L

Extração total.

Montagem no fundo do móvel.

Opção entre volume de:

- 31L (24L + 7L).
- 30L (2 x 15L).

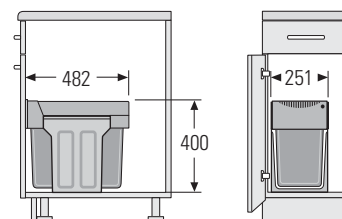

M	L (mm)	P (mm)	A (mm)	V (L)	Acab.	Código
30	251	482	400	31	Cinza escuro	H.T3666111
30	251	482	400	30	Cinza escuro	H.T3666101



Tandem 15+15L Black Edition

Extração total.
Montagem no fundo do móvel.
Volume de 30L (15L + 15L).

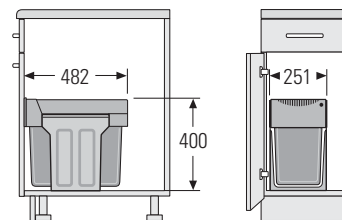

Mód.	L (mm)	P (mm)	A (mm)	V (L)	Acab.	Código
30	251	482	400	30	Preto	H.T3666851

Tandem 15+15L Anti-Bactérias

Extração total.
Montagem no fundo do móvel.
Menos 99.9 % bactérias nas superfícies plásticas: tampa, painel de abertura e baldes.
Propriedade anti-bacteriana em plena ação por mais de 15 anos.
Testado em mais de 50 tipos de bactérias.
Volume de 30L (15L + 15L).

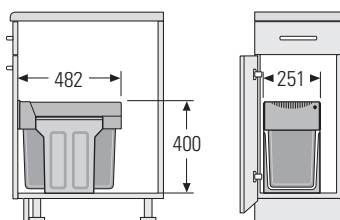

Mód.	L (mm)	P (mm)	A (mm)	V (L)	Acab.	Código
30	251	482	400	30	Anti-bactérias	H.T3666661



Tandem Single Box 24L

Extração total.
Montagem no fundo do móvel.
Volume de 24L (balde único).

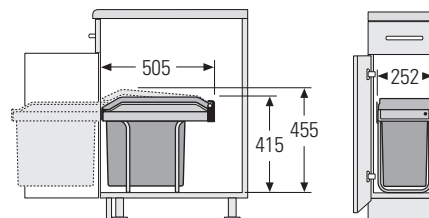

Mód.	L (mm)	P (mm)	A (mm)	V (L)	Acab.	Código
30	252	505	415/455	24	Cinza escuro	H.T3650241

Tandem 15+15L (3650)

Extração parcial.
Montagem no fundo do móvel.
Volume de 30L (15L + 15L).

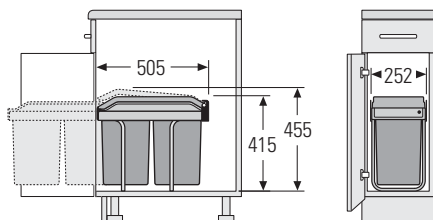

Mód.	L (mm)	P (mm)	A (mm)	V (L)	Acab.	Código
30	252	505	415/455	30	Cinza escuro	H.T3650101



Space-Saving Tandem 18+18L

Extração total.
Montagem no fundo do móvel.
Volume de 36L (18L + 18L).

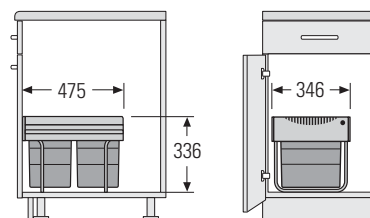

Mód.	L (mm)	P (mm)	A (mm)	V (L)	Acab.	Código
40	346	475	336	36	Cinza	H.ST3641121
40	346	475	336	36	Cinza escuro	H.ST3641521

Space-Saving Tandem Comfort 20+20L KS

Extração total.
Montagem no fundo do móvel.
Inclui escova e apanhador.
Volume de 40L (20L + 20L).

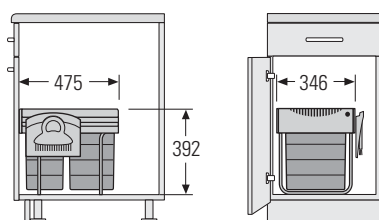

Mód.	L (mm)	P (mm)	A (mm)	V (L)	Acab.	Código
40	346	475	392	40	Cinza	H.ST3641221





Space-Saving Tandem S 18+12L

Extração total.
Montagem no fundo do móvel.
Volume de 30L (18L + 12L).

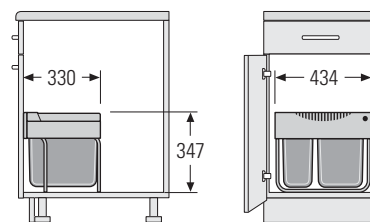

Mód.	L (mm)	P (mm)	A (mm)	V (L)	Acab.	Código
50	434	330	347	30	Cinza	H.ST3644701
50	434	330	347	30	Cinza escuro	H.ST3644901

AS Space-Saving Tandem S Plus 18+12L

Extração total.
Mecanismo de abertura com a porta.
Montagem no fundo do móvel.
Prateleira montada nas ilhargas.
Volume de 30L (18L + 12L).

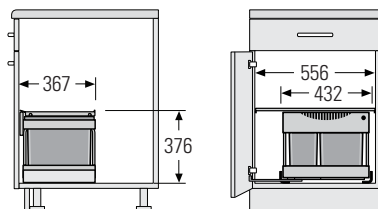

Mód.	L (mm)	P (mm)	A (mm)	V (L)	Acab.	Código
60	556	367	376	30	Cinza	H.STP3644801



AS Space-Saving Tandem S Plus 18+8+8L

Extração total.
Mecanismo de abertura com a porta.
Montagem no fundo do móvel.
Prateleira montada nas ilhargas.
Tampa para um dos baldes de 8L.
Volume de 28L (12L + 8L + 8L).

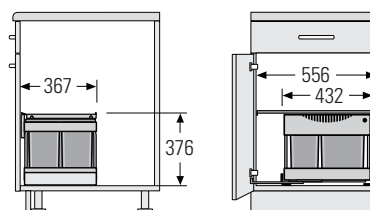

Mód.	L (mm)	P (mm)	A (mm)	V (L)	Acab.	Código
60	556	367	376	28	Cinza	H.STP3644831

AS Tandem 13/13

Extração total.

Montagem no fundo do móvel.

Volume de 26L (13L + 13L).

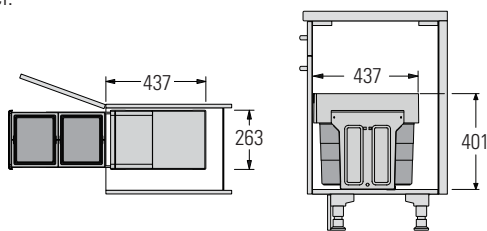

Mód.	L (mm)	P (mm)	A (mm)	V (L)	Acab.	Código
40	263	437	401	26	Cinza escuro	H.AST3666901



AS Tandem 28

Extração total.

Montagem no fundo do móvel.

Volume de 28L (balde único).

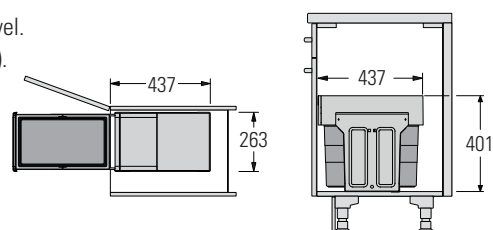

Mód.	L (mm)	P (mm)	A (mm)	V (L)	Acab.	Código
40	263	437	401	28	Cinza escuro	H.AST3666911

AS Tandem 8/8/8

Extração total.

Montagem no fundo do móvel.

Volume de 24L (3 x 8L).

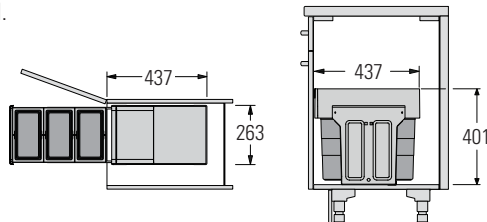

Mód.	L (mm)	P (mm)	A (mm)	V (L)	Acab.	Código
40	263	437	401	24	Cinza escuro	H.AST3666921



AS ALLEGRO

Sistema composto por um tapete anti-derrapante, os baldes e uma tampa extensível.
Montado na ilharga, 16-19 mm.

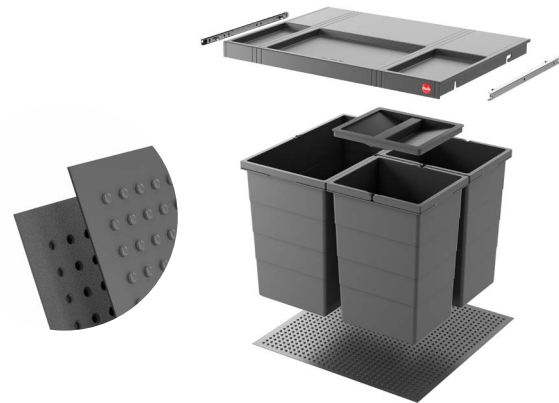

600	2 x 14 L	14 + 2 x 6,5 L	18 + 2 x 8 L
	2 x 18 L + 2 x 8 L	2 x 28 L	28 + 2 x 13 L
	2 x 28 L	28 + 2 x 13 L	

AS Allegro 220 14/14

Volume de 28L (14L + 14L).
Montado na ilharga, 16-19 mm.
Tampa de plástico extensível montada na ilharga.

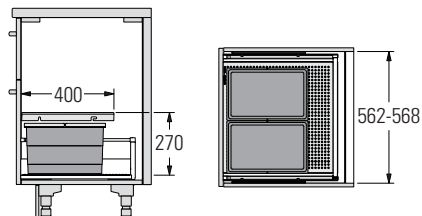

M	L	P	A	V	Acab.	Código
Mód.	L (mm)	P (mm)	A (mm)	V (L)		
60	476	473	270	28	Cinza escuro	H.A3301611

AS Allegro 220 14/6,5/6,5/D

Volume de 27L (14L + 2 x 6,5L).
Montado na ilharga, 16-19 mm.
Tampa para balde de 6,5L.
Tampa de plástico extensível montada na ilharga.

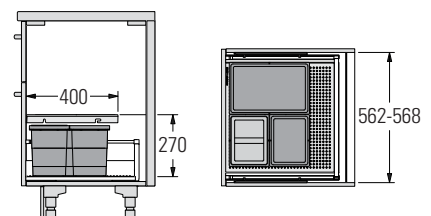

M	L	P	A	V	Acab.	Código
Mód.	L (mm)	P (mm)	A (mm)	V (L)		
60	476	473	270	27	Cinza escuro	H.A3301621

AS Allegro 295 18/8/8/D



Volume de 34L (18L + 2 x 8L).
Montado na ilharga, 16-19 mm.
Tampa para balde de 8L.
Tampa de plástico extensível
montada na ilharga.

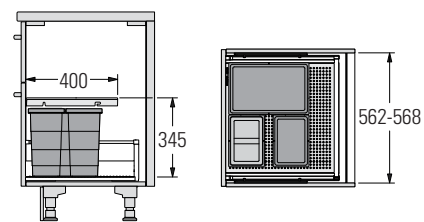

Mód.	L (mm)	P (mm)	A (mm)	V (L)	Acab.	Código
60	476	473	345	34	Cinza escuro	H.A3301631

AS Allegro 295 18/18/8/8/D

Volume de 52L (2 x 18L + 2 x 8L).
Montado na ilharga, 16-19 mm.
Tampa para balde de 8L.
Tampa de plástico extensível
montada na ilharga.

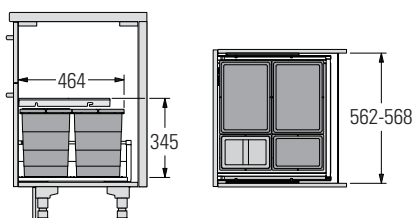

Mód.	L (mm)	P (mm)	A (mm)	V (L)	Acab.	Código
60	476	473	345	52	Cinza escuro	H.A3301641

AS Allegro 350 28/28



Volume de 56L (2 x 28L).
Montado na ilharga, 16-19 mm.
Tampa de plástico extensível
montada na ilharga.

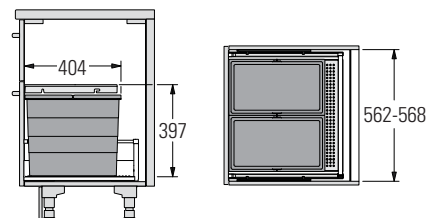

Mód.	L (mm)	P (mm)	A (mm)	V (L)	Acab.	Código
60	476	473	397	56	Cinza escuro	H.A3301651

AS Allegro 350 28/13/13/D

Volume de 54L (28L + 2 x 13L).
Montado na ilharga, 16-19 mm.
Tampa para balde de 13L.
Tampa de plástico extensível montada na ilharga.

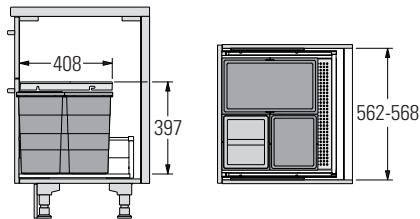

M	L (mm)	P (mm)	A (mm)	V (L)	Acab.	Código
Mód.	476	473	397	54	Cinza escuro	H.A3301661

AS Allegro 380 28/28

Volume de 56L (2 x 28L).
Montado na ilharga, 16-19 mm.
Tampa de plástico extensível montada na ilharga.

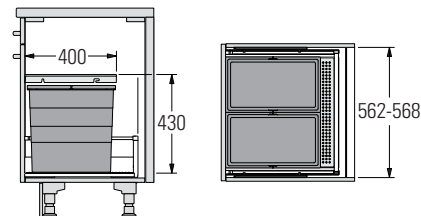

M	L (mm)	P (mm)	A (mm)	V (L)	Acab.	Código
Mód.	476	473	430	56	Cinza escuro	H.A3301671

AS Allegro 380 28/13/13/D

Volume de 54L (28L + 2 x 13L).
Montado na ilharga, 16-19 mm.
Tampa para balde de 13L.
Tampa de plástico extensível montada na ilharga.

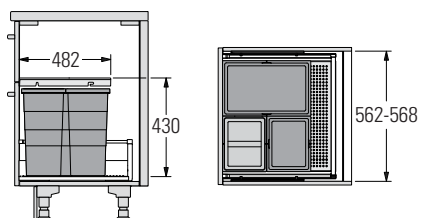

M	L (mm)	P (mm)	A (mm)	V (L)	Acab.	Código
Mód.	476	473	430	54	Cinza escuro	H.A3301681

EASY CARGO

Extração total.

Unidade integrada na prateleira.

Montagem no fundo do móvel.

400

42 L

500

30 + 19 L

Easy Cargo 42L

Extração total.

Unidade integrada na prateleira.

Montagem no fundo do móvel.

Volume de 42L (balde único).

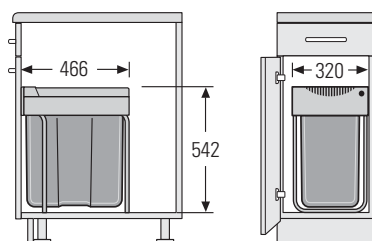

BALDES DE LIXO



Código

Mód.

L (mm)

P (mm)

A (mm)

V (L)

Acab.

40

320

466

542

42

Cinza

H.E3668401



Easy Cargo 30+19L

Extração total.

Montagem no fundo do móvel.

Volume de 49L (30L + 19L).

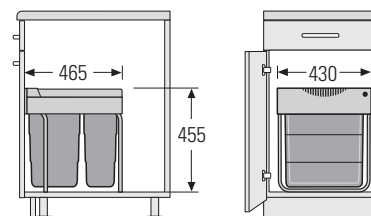

Código

Mód.

L (mm)

P (mm)

A (mm)

V (L)

Acab.

50

430

465

455

49

Cinza

H.E3668501

CARGO AQUA

Abertura automática.

Corrediças cobertas, sincronizadas e soft-closing.

Para instalação junto de um purificador de água.

600 13 + 13 L 28 L

750 28 + 18 L

900 28 + 13 + 13 L



AS Cargo Aqua 600 13/13/D

Volume de 26L (2 x 13L).

Montado apenas numa ilharga, esquerda ou direita, de 16-19 mm.

Self-closing.

Uma tampa para balde de 13L.

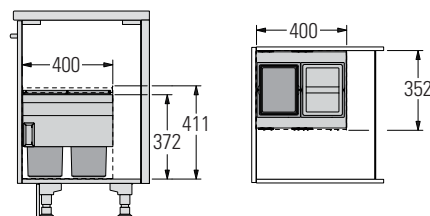

Mód.	L (mm)	P (mm)	A (mm)	V (L)	Acab.	Código
60	352	400	411	26	Cinza escuro	H.A3608601

AS Cargo Aqua 600 28

Volume de 28L (28L).

Montado apenas numa ilharga, esquerda ou direita, de 16-19 mm.

Self-closing.

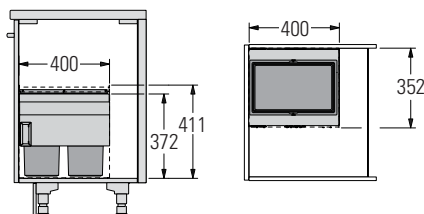

Mód.	L (mm)	P (mm)	A (mm)	V (L)	Acab.	Código
60	352	400	411	28	Cinza escuro	H.A3608611





AS Cargo Aqua 750 28/18

Volume de 46L (28 + 18L).
Montado apenas numa ilharga,
esquerda ou direita, de 16-19 mm.
Self-closing.

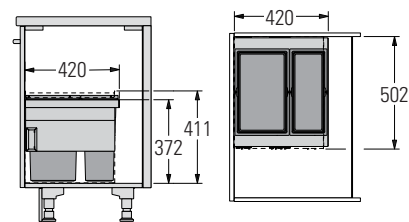

Mód.	L (mm)	P (mm)	A (mm)	V (L)	Acab.	Código
75	502	420	411	46	Cinza escuro	H.A3608751

AS Cargo Aqua 900 28/13/13/D

Volume de 54L (28 + 13L).
Montado apenas numa ilharga,
esquerda ou direita, de 16-19 mm.
Self-closing.
Uma tampa para balde de 13L.

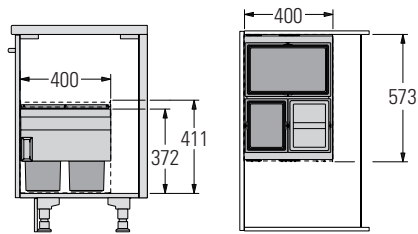

Mód.	L (mm)	P (mm)	A (mm)	V (L)	Acab.	Código
90	573	400	411	54	Cinza escuro	H.A3608901



INSTALAÇÃO NA GAVETA

Abertura automática.

Instalação dentro de gaveta disponível. Gaveta não fornecida.

Prateleira de plástico.

300

38 + 7 L

15 + 15 L



Euro Cargo 300 38+7L

Abertura automática.

Instalação dentro de gaveta disponível.

Prateleira de plástico.

Volume de 45L (38L + 7L).

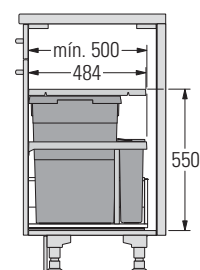

Mód.



L (mm)



P (mm)



A (mm)



V (L)



Acab.

Código

30

259

484/500

550

45

Cinza escuro

H.EC3669101

AS Tandem 300 15+15L

Abertura automática.

Instalação dentro de gaveta disponível.

Prateleira de plástico.

Volume de 30L (2 x 15L).

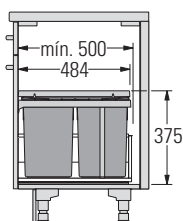

Mód.



L (mm)



P (mm)



A (mm)



V (L)



Acab.

Código

30

259

484

375

30

Cinza escuro

H.T3669001

SOLO

Extração total.
Montagem no fundo do móvel.

300 20 L

400 20 L



Solo 20L

Extração total.
Montagem no fundo do móvel.
Volume de 20L (balde único).

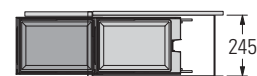
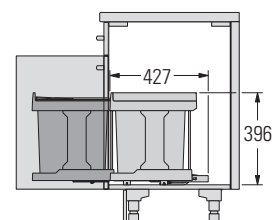

Mód.	L (mm)	P (mm)	A (mm)	V (L)	Acab.	Código
30	245	427	396	20	Cinza escuro	H.S3635001

Solo 20L com Abertura Automática

Abertura com acompanhamento da porta automático.
Extração total.
Montagem no fundo do móvel.
Volume de 20 (balde único).

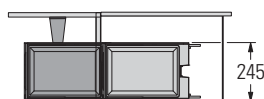
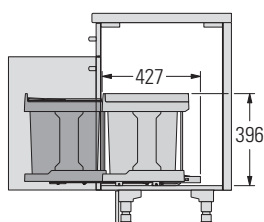

Mód.	L (mm)	P (mm)	A (mm)	V (L)	Acab.	Código
40	245	427	396	20	Cinza escuro	H.S3636001



MONO

Viragem e inclinação da tampa sem mola.
Montado na ilharga.

400 12 L 15 L 20 L



Mono 15L

Viragem e inclinação da tampa sem mola.
Montado na ilharga.
Volume de 15L (balde único).

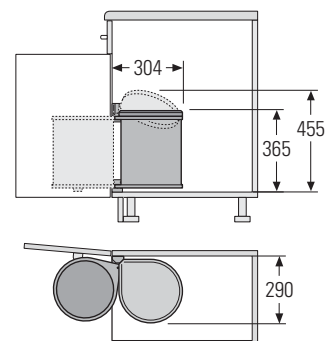

Mód.	L (mm)	P (mm)	A (mm)	V (L)	Acabamento		Código
					Corpo	Tampa	
40	290	304	365/455	15	Branco	Branco	H.M3515001
40	290	304	365/455	15	Antracite	Preto	H.M3515071
40	290	304	365/455	15	Inox	Branco	H.M3515011
40	290	304	365/455	15	Inox	Preto	H.M3515031

Mono 12L

Viragem e inclinação da tampa sem mola.
Montado na ilharga.
Volume de 12L (balde único).

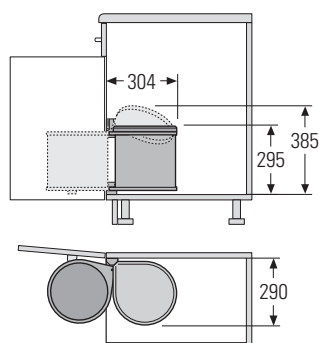

Mód.	L (mm)	P (mm)	A (mm)	V (L)	Acabamento		Código
					Corpo	Tampa	
40	290	304	295/385	12	Branco	Branco	H.M3512001
40	290	304	295/385	12	Inox	Preto	H.M3512031
40	290	304	295/385	12	Inox	Branco	H.M3512011





Mono 20L

Viragem e inclinação da tampa sem mola.
Montado na ilharga.
Volume de 20L (balde único).

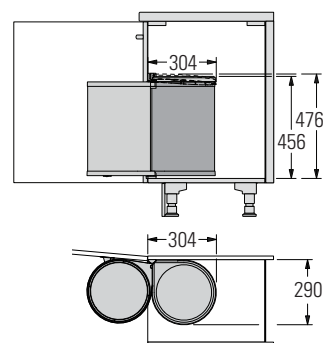

Mód.	L (mm)	P (mm)	A (mm)	V (L)	Acabamento		
					Corpo	Tampa	Código
40	290	304	456/476	20	Inox	Preto	H.M3520001
40	290	304	456/476	20	Antracite	Preto	H.M3520071

OUTROS

Baldes diversos.

450 18 L variável

Uno 18L

Tampa com mecanismo de virar e inclinar.
Montado na ilharga.
Volume de 18L (balde único).

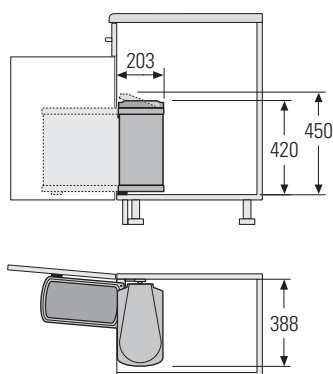

Mód.	L (mm)	P (mm)	A (mm)	V (L)	Acab.	Código
45	388	203	420/450	18	Aço inoxidável	H.U3418101



Balde Depot

Porta-sacos de lavanderia.
Suporte de parede e tampa em chapa de metal.
Com dispositivo de fixação para sacos de plástico ou sacos de tecido de algodão.
Fornecido com saco de algodão.
Para aplicar na ilharga lateral.

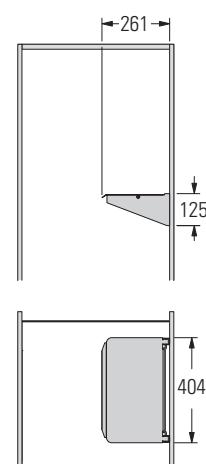

L (mm)	P (mm)	A (mm)	Acab.	Código
404	261	125	Lacado branco	H.D3272111
404	261	125	Cinza escuro	H.D3272121



Balde para Reciclagem 53

Instalação na base da gaveta.

Volume de 53L.

Módulo	L (mm)	P (mm)	A (mm)	V (L)	Acab.	Código
M	260	340	623	53	Preto	H.3273101

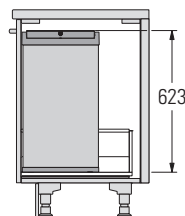
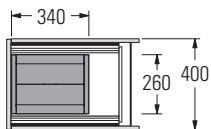

ACESSÓRIOS



Libero 3.0 — Abertura sem mãos

Mecanismo para abertura automática de sistemas de lixo montados na frente da porta ou gaveta. Operável com sensor eletrônico acionável com o pé ou com comando de voz, quando integrado com o sistema de casa inteligente Amazon Alexa.

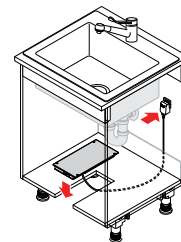

Destaques:

- Para módulos de 30 a 120.
- 5V 2A, com entrada USB-C. Para tomadas de 110-230V. Inclui cabo USB-C de 2m.
- Inclui luz LED para localização do sensor, com intensidade ajustável e desligável.
- Configuração da força de abertura, alcance do sensor e outras no Web Browser.
- Identifica obstáculos com sensor de fricção.
- Proteção contra água com certificação IP 21.

L (mm)	P (mm)	A (mm)	Código
157	300	33	H.3697301

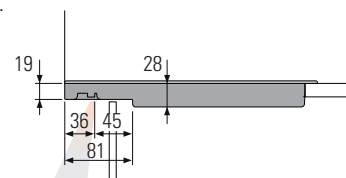

Kick-and-Go 1301

Pedal para portas e gavetas inferiores.

H.3691301

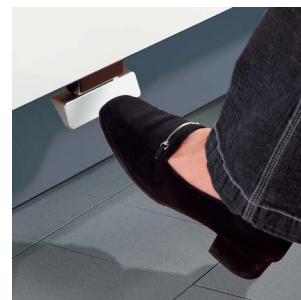
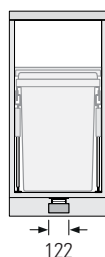
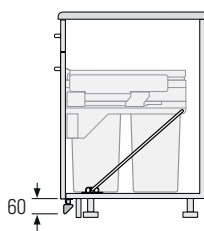

Kick-and-Go 2021

Pedal para portas com dobradiças a partir de 300 mm.

H.3692021