



# BALDES DE LIXO

CASATREND | HAILO

# CARGO SYNCHRO

Abertura automática.

Corrediças cobertas, sincronizadas e soft-close.

Montado na ilharga, ajustável para 16-19 mm.

Prateleira de metal/plástico de puxar com tapete anti-derrapante de borracha.

300	30 L	
450	55 L	18 + 18 L
500	28 + 18 L	18 + 13 + 13 L
600	28 + 28 L	28 + 13 + 13 L

## Cargo Synchro 300 30L

Abertura automática.

Corrediças cobertas, sincronizadas e soft-close.

Montado na ilharga, ajustável para 16-19 mm.

Prateleira de metal/plástico de puxar, com tapete anti-derrapante de borracha.

Volume de 30L (balde único).

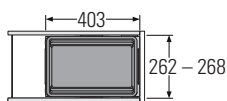
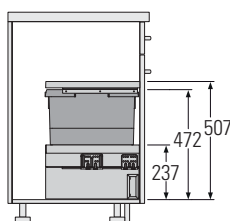

Mód.	L (mm)	P (mm)	A (mm)	V (L)	Acab.	Código
30	262-268	403	507	30	Cinza escuro	H.CS3608311



## Cargo Synchro 450 55L

Abertura automática.

Corrediças cobertas, sincronizadas e soft-close.

Montado na ilharga, ajustável para 16-19 mm.

Prateleira de metal/plástico de puxar, com tapete anti-derrapante de borracha.

Volume de 55L (balde único).

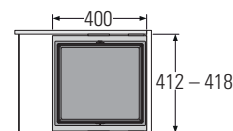
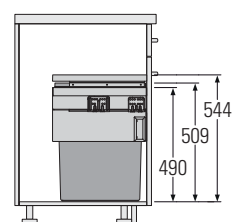

Mód.	L (mm)	P (mm)	A (mm)	V (L)	Acab.	Código
45	412-418	400	544	55	Cinza escuro	H.CS3608461

## Cargo Synchro 450 18+18L

Abertura automática.

Corrediças cobertas, sincronizadas e soft-close.

Montado na ilharga, ajustável para 16-19 mm.

Prateleira de metal/plástico de puxar, com tapete anti-derrapante de borracha.

Volume de 36L (18L + 18L).

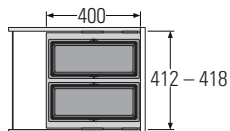
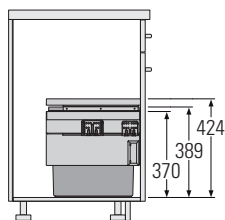

Mód.	L (mm)	P (mm)	A (mm)	V (L)	Acab.	Código
45	412-418	400	424	36	Cinza escuro	H.CS3608471



## Cargo Synchro 500 28+18L

Abertura automática.

Corrediças cobertas, sincronizadas e soft-close.

Montado na ilharga, ajustável para 16-19 mm.

Prateleira de metal/plástico de puxar, com tapete anti-derrapante de borracha.

Volume de 46L (28L + 18L).

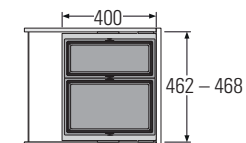
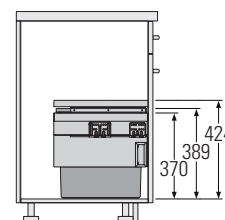

Mód.	L (mm)	P (mm)	A (mm)	V (L)	Acab.	Código
50	462-468	400	424	46	Cinza escuro	H.CS3608521

## Cargo Synchro 500 18+13+13L D

Abertura automática.

Corrediças cobertas, sincronizadas e soft-close.

Montado na ilharga, ajustável para 16-19 mm.

Prateleira de metal/plástico de puxar, com tapete anti-derrapante de borracha.

1 tampa de balde.

Volume de 44L (18L + 13L + 13L).

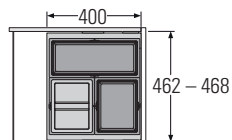
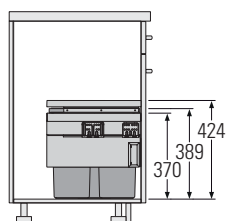

Mód.	L (mm)	P (mm)	A (mm)	V (L)	Acab.	Código
50	462-468	400	424	44	Cinza escuro	H.CS3608531



## Cargo Synchro 600 28+28L

Abertura automática.  
 Corrediças cobertas, sincronizadas e soft-close.  
 Montado na ilharga, ajustável para 16-19 mm.  
 Prateleira de metal/plástico de puxar, com tapete anti-derrapante de borracha.  
 Volume de 56L (28L + 28L).

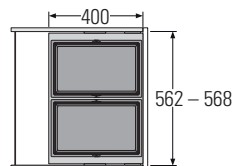
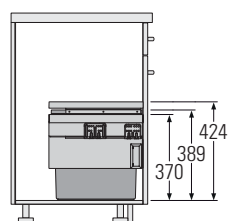

Mód.	L (mm)	P (mm)	A (mm)	V (L)	Acab.	Código
60	562-568	400	424	56	Cinza escuro	H.CS3608621

## Cargo Synchro 600 28+13+13L D

Abertura automática.  
 Corrediças cobertas, sincronizadas e soft-close.  
 Montado na ilharga, ajustável para 16-19 mm.  
 Prateleira de metal/plástico de puxar, com tapete anti-derrapante de borracha.  
 1 tampa para balde de 13L.  
 Volume de 54L (28L + 13L + 13L).

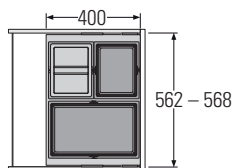
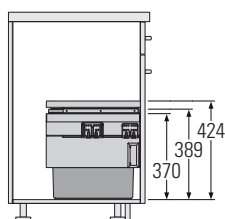

Mód.	L (mm)	P (mm)	A (mm)	V (L)	Acab.	Código
60	562-568	400	424	54	Cinza escuro	H.CS3608631

# EURO CARGO

Abertura automática.  
Corrediças cobertas, sincronizadas e soft-close.  
Montado na ilharga, ajustável para 16-19 mm.  
Prateleira de chapa metálica.

400	38 + 17 L
450	38 + 38 L
500	38 + 38 L
600	38 + 38 + 12 + 2,5 L

## Euro Cargo 400 38+7L

Abertura automática.  
Corrediças cobertas, sincronizadas e soft-close.  
Montado na ilharga, ajustável para 16-19 mm.  
Prateleira de chapa metálica.  
Volume de 45L (38L + 7L).

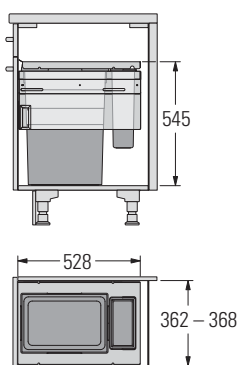

Mód.	L (mm)	P (mm)	A (mm)	V (L)	Acab.	Código
40	362-368	528	545	45	Cinza claro	H.EC3619421



## Euro Cargo 450 38+38L

Abertura automática.  
Corrediças cobertas, sincronizadas e soft-close.  
Montado na ilharga, ajustável para 16-19 mm.  
Prateleira de chapa metálica.  
Volume de 76L (38L + 38L).

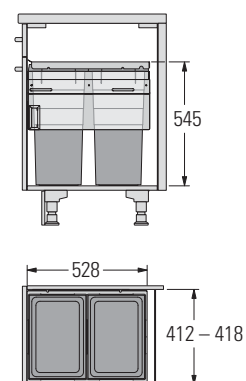

Mód.	L (mm)	P (mm)	A (mm)	V (L)	Acab.	Código
45	412-418	528	545	76	Cinza claro	H.EC3619471
45	412-418	528	545	76	Cinza escuro	H.EC3619731



## Euro Cargo 500 38+38L

Abertura automática.  
 Corrediças cobertas, sincronizadas e soft-close.  
 Montado na ilharga, ajustável para 16-19 mm.  
 Prateleira de chapa metálica.  
 Volume de 76L (38L + 38L).

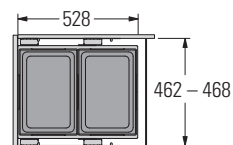
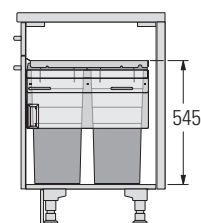

Mód.	L (mm)	P (mm)	A (mm)	V (L)	Acab.	Código
50	462-468	528	545	76	Cinza claro	H.EC3619521
50	462-468	528	545	76	Cinza escuro	H.EC3619721

## Euro Cargo 600 38+38+12+2,5L D

Abertura automática.  
 Corrediças cobertas, sincronizadas e soft-close.  
 Montado na ilharga, ajustável para 16-19 mm.  
 Prateleira de chapa metálica.  
 1 tampa de balde de 12L.  
 Volume de 90,5L (38L + 38L + 12L + 2,5L).

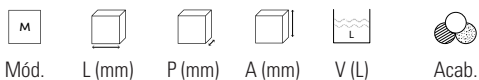
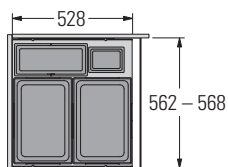
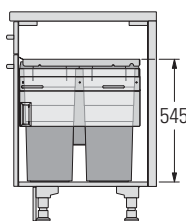

Mód.	L (mm)	P (mm)	A (mm)	V (L)	Acab.	Código
60	562-568	528	545	90,5	Cinza claro	H.EC3619621
60	562-568	528	545	90,5	Cinza escuro	H.EC3619771

# AS CARGO

Abertura automática.  
Corrediças cobertas soft-close.  
Montado na ilharga, ajustável para 16-19 mm.  
Prateleira de chapa metálica.

300	15 + 10 L			
450	14 + 14 L		21 + 17 L	
500	20 + 14 L	17 + 13 + 13 L	28 + 17 L	
600	20 + 10 + 10 L	28 + 13 + 13 L	28 + 28 L	13 + 13 + 13 + 13 L

## Cargo Soft Short 450 14+14L

Abertura automática.  
Corrediças cobertas soft-close.  
Montado na ilharga, ajustável para 16-19 mm.  
Prateleira de chapa metálica.  
Volume de 28L (14L + 14L).



Compatível com mecanismo Libero

Mód.	L (mm)	P (mm)	A (mm)	V (L)	Acab.	Código
45	412-418	332/448	370	28	Cinza	H.SS3610481

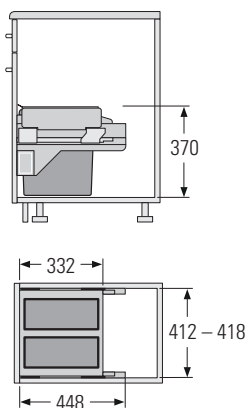

## Cargo Soft Short 500 20+14L

Abertura automática.  
Corrediças cobertas soft-close.  
Montado na ilharga, ajustável para 16-19 mm.  
Prateleira de chapa metálica.  
Volume de 34L (20L + 14L).



Compatível com mecanismo Libero

Mód.	L (mm)	P (mm)	A (mm)	V (L)	Acab.	Código
50	462-468	332/448	370	34	Cinza	H.SS3610581

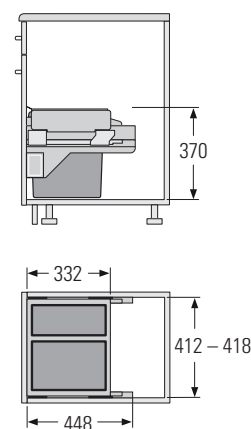

## Cargo Soft Short 600 20+10+10L D

Abertura automática.  
Corrediças cobertas soft-close.  
Montado na ilharga, ajustável para 16-19 mm.  
Prateleira de chapa metálica.  
1 tampa para balde de 10L.  
Volume de 40L (20L + 10L + 10L).



Compatível com mecanismo Libero



Mód.



L (mm)



P (mm)



A (mm)



V (L)



Acab.

Código

60

562-568

332/448

370

40

Cinza

H.SS3610681

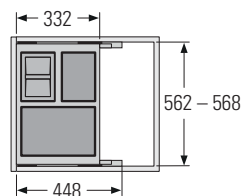
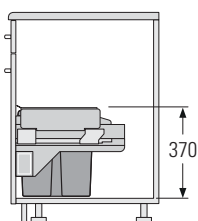

## AS Cargo 300 15+10L D

Abertura automática.  
Corrediças cobertas, sincronizadas e soft-close.  
Montado na ilharga, ajustável para 16-19 mm.  
Prateleira de chapa metálica.  
1 tampa para balde de 10L.  
Volume de 25L (15L + 10L)

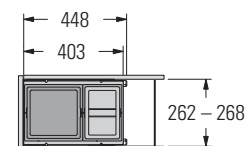
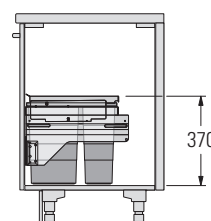

Mód.



L (mm)



P (mm)



A (mm)



V (L)



Acab.

Código

30

262-268

403/448

388

25

Cinza escuro

H.AS3610871

## AS Cargo 450 21+17L

Abertura automática.  
Corrediças cobertas, sincronizadas e soft-close.  
Montado na ilharga, ajustável para 16-19 mm.  
Prateleira de chapa metálica.  
Volume de 38L (21L + 17L)

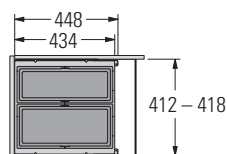
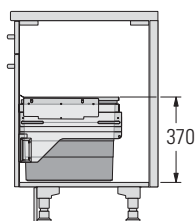

Mód.



L (mm)



P (mm)



A (mm)



V (L)



Acab.

Código

45

412-418

434/448

370

38

Cinza escuro

H.AS3610811





## AS Cargo 500 28+17L

Abertura automática.  
Corrediças cobertas, sincronizadas e soft-close.  
Montado na ilharga, ajustável para 16-19 mm.  
Prateleira de chapa metálica.  
Volume de 45L (28L + 17L)

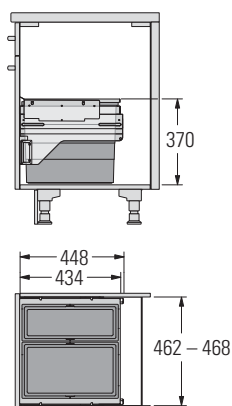

Mód.	L (mm)	P (mm)	A (mm)	V (L)	Acab.	Código
50	462-468	434/448	370	45	Cinza escuro	H.AS3610821



## AS Cargo 500 17+13+13L D

Abertura automática.  
Corrediças cobertas, sincronizadas e soft-close.  
Montado na ilharga, ajustável para 16-19 mm.  
Prateleira de chapa metálica.  
1 tampa para balde de 13L.  
Volume de 43L (17L + 2 x 13L).

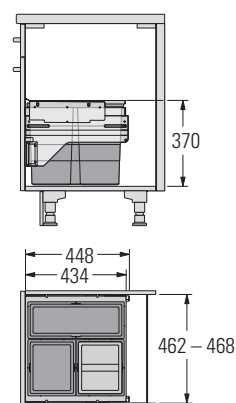

Mód.	L (mm)	P (mm)	A (mm)	V (L)	Acab.	Código
50	462-468	434/448	370	43	Cinza escuro	H.AS3610831

## AS Cargo 600 28+13+13L D

Abertura automática.  
Corrediças cobertas, sincronizadas e soft-close.  
Montado na ilharga, ajustável para 16-19 mm.  
Prateleira de chapa metálica.  
1 tampa para balde de 13L.  
Volume de 54L (28L + 2 x 13L).

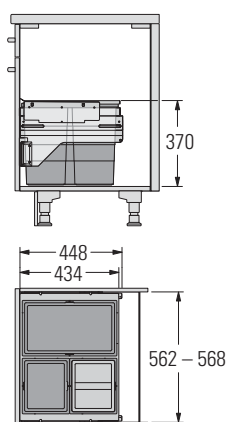

Mód.	L (mm)	P (mm)	A (mm)	V (L)	Acab.	Código
60	562-568	434/448	370	54	Cinza escuro	H.AS3610851





## AS Cargo 600 28+28L

Abertura automática.  
 Corrediças cobertas, sincronizadas e soft-close.  
 Montado na ilharga, ajustável para 16-19 mm.  
 Prateleira de chapa metálica.  
 Volume de 56L (2 x 28L).

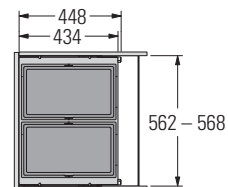
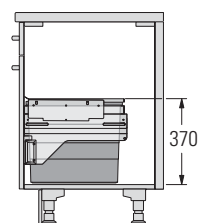

Mód.	L (mm)	P (mm)	A (mm)	V (L)	Acab.	Código
60	562-568	434/448	370	56	Cinza escuro	H.AS3610841

## AS Cargo 600 13+13+13+13L D

Abertura automática.  
 Corrediças cobertas, sincronizadas e soft-close.  
 Montado na ilharga, ajustável para 16-19 mm.  
 Prateleira de chapa metálica.  
 1 tampa de balde de 13L.  
 Volume de 52L (13L x 4)

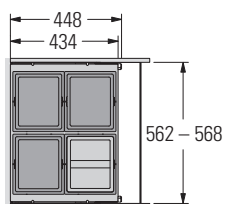
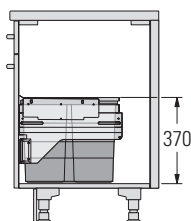

Mód.	L (mm)	P (mm)	A (mm)	V (L)	Acab.	Código
60	562-568	434/448	370	52	Cinza escuro	H.AS3610861

# AS EURO CARGO

Abertura automática.  
Corrediças cobertas soft-close.  
Montado na ilharga, ajustável para 16-19 mm.  
Prateleira de chapa metálica.

300	30 L	
450	19 + 19 L	
500	30 + 19 L	
600	30 + 30 L	30 + 13 + 13 L

## AS Euro Cargo S 300 30L

Abertura automática.  
Corrediças cobertas soft-close.  
Montado na ilharga, ajustável para 16-19 mm.  
Prateleira de chapa metálica.  
Volume de 30L (balde único).



Compatível com mecanismo Libero

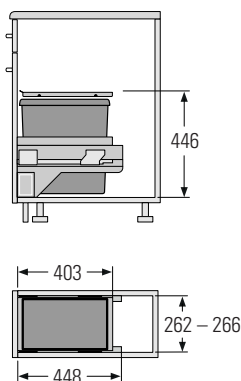

Mód.	L (mm)	P (mm)	A (mm)	V (L)	Acab.	Código
30	262-268	403/448	446	30	Cinza	H.EC3610121



## AS Euro Cargo S 450 19+19L

Abertura automática.  
Corrediças cobertas soft-close.  
Montado na ilharga, ajustável para 16-19 mm.  
Prateleira de chapa metálica.  
Volume de 38L (19L + 19L).



Compatível com mecanismo Libero

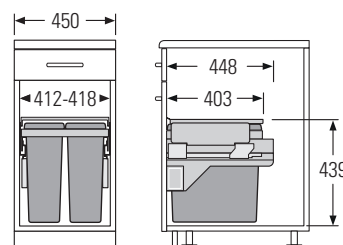

Mód.	L (mm)	P (mm)	A (mm)	V (L)	Acab.	Código
45	412-418	403/448	439	38	Cinza	H.EC3610471



## AS Euro Cargo S 500 30+19L

Abertura automática.  
 Corrediças cobertas soft-close.  
 Montado na ilharga, ajustável para 16-19 mm.  
 Prateleira de chapa metálica.  
 Volume de 49L (30L + 19L).

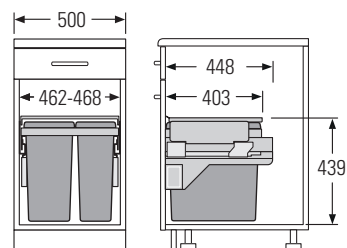

Compatível com mecanismo Libero

Mód.	L (mm)	P (mm)	A (mm)	V (L)	Acab.	Código
50	462-468	403/448	439	49	Cinza	H.EC3610521

## AS Euro Cargo S 600 30+30L

Abertura automática.  
 Corrediças cobertas, sincronizadas e soft-close.  
 Montado na ilharga, ajustável para 16-19 mm.  
 Prateleira de chapa metálica.  
 Volume de 60L (30L + 30L)

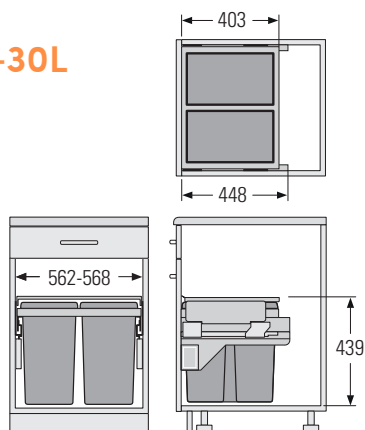

Mód.	L (mm)	P (mm)	A (mm)	V (L)	Acab.	Código
60	562-568	403/448	439	60	Cinza	H.AS3610621



## AS Euro Cargo S 600 30+13+13L D

Abertura automática.  
 Corrediças cobertas soft-close.  
 Montado na ilharga, ajustável para 16-19 mm.  
 Prateleira de chapa metálica.  
 Volume de 56L (30L + 13L + 13L).

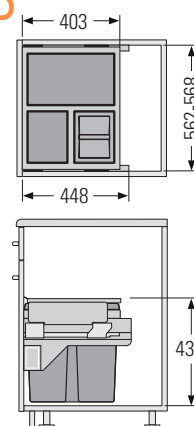

Compatível com mecanismo Libero

Mód.	L (mm)	P (mm)	A (mm)	V (L)	Acab.	Código
60	562-568	403/448	439	56	Cinza	H.AS3610631

# TRIPLE XL

Abertura automática.

Instalado no fundo de qualquer gaveta standard.

Ajustável a ilhargas de 16-19 mm.

Laterais do balde cobrem as corrediças da gaveta. Não fornecidas.

Prateleira de chapa metálica montada na ilharga.

450	55 L	18 + 18 L
500	28 + 18 L	18 + 13 + 13 L
600	28 + 28 L	28 + 13 + 13 L
800	28 + 28 + 18 L	
900	28 + 28 + 28 L	

## Triple XL 450 55L

Abertura automática.

Instalado no fundo de qualquer gaveta standard.

Ajustável a ilhargas de 16-19 mm.

Laterais do balde cobrem as corrediças da gaveta.

Prateleira de chapa metálica montada na ilharga.

Profundidade mínima da gaveta: 420 mm.

Volume de 55L (balde único).



Compatível com mecanismo Libero

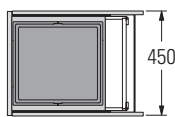
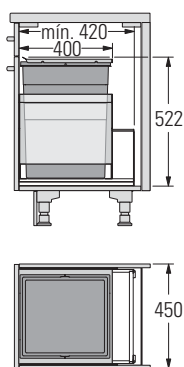

Mód.



P (mm)



A (mm)



V (L)



Acab.

Código

45

400/420

522

55

Cinza escuro

H.TX3631481



## Triple XL 450 18+18L

Abertura automática.

Instalado no fundo de qualquer gaveta standard.

Ajustável a ilhargas de 16-19 mm.

Laterais do balde cobrem as corrediças da gaveta.

Prateleira de chapa metálica montada na ilharga.

Profundidade mínima da gaveta: 420 mm.

Volume de 36L (2 x 18L).



Compatível com mecanismo Libero

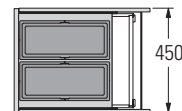
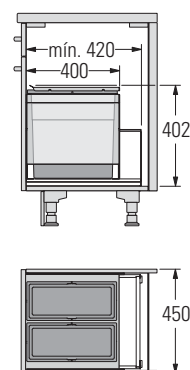

Mód.



P (mm)



A (mm)



V (L)



Acab.

Código

45

400/420

402

36

Cinza escuro

H.TX3631491

## Triple XL 500 28+18L

Abertura automática.

Instalado no fundo de qualquer gaveta standard.

Ajustável a ilhargas de 16-19 mm.

Laterais do balde cobrem as corredeiras da gaveta.

Prateleira de chapa metálica montada na ilharga.

Profundidade mínima da gaveta: 420 mm.

Volume de 46L (28L + 18L).



Compatível com mecanismo Libero

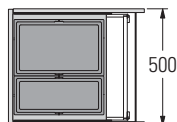
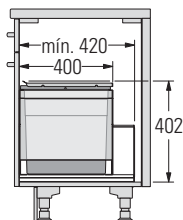

Mód.



P (mm)



A (mm)



V (L)



Acab.

Código

50

400/420

402

46

Cinza escuro

H.TX3631581



## Triple XL 500 18+13+13L D

Abertura automática.

Instalado no fundo de qualquer gaveta standard.

Ajustável a ilhargas de 16-19 mm.

Laterais do balde cobrem as corredeiras da gaveta.

Prateleira de chapa metálica montada na ilharga.

Profundidade mínima da gaveta: 420 mm.

Volume de 44L (18L + 2 x 13L).



Compatível com mecanismo Libero

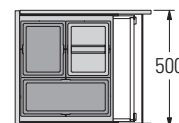
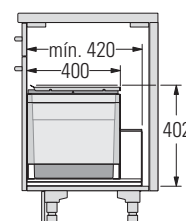

Mód.



P (mm)



A (mm)



V (L)



Acab.

Código

50

400/420

402

44

Cinza escuro

H.TX3631591

## Triple XL 600 28+28L

Abertura automática.

Instalado no fundo de qualquer gaveta standard.

Ajustável a ilhargas de 16-19 mm.

Laterais do balde cobrem as corredeiras da gaveta.

Prateleira de chapa metálica montada na ilharga.

Profundidade mínima da gaveta: 420 mm.

Volume de 56L (2 x 28L).



Compatível com mecanismo Libero

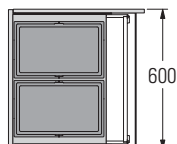
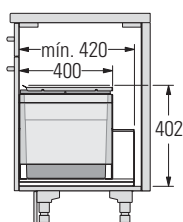

Mód.



P (mm)



A (mm)



V (L)



Acab.

Código

60

400/420

402

56

Cinza escuro

H.TX3631681



## Triple XL 600 28+13+13L D

Abertura automática.  
 Instalado no fundo de qualquer gaveta standard.  
 Ajustável a ilhargas de 16-19 mm.  
 Laterais do balde cobrem as corredeiras da gaveta.  
 Prateleira de chapa metálica montada na ilharga.  
 Profundidade mínima da gaveta: 420 mm.  
 Volume de 54L (28L + 2 x 13L).



Compatível com mecanismo Libero



Mód.



P (mm)



A (mm)



V (L)



Acab.

Código

60

400/420

402

54

Cinza escuro

H.TX3631691

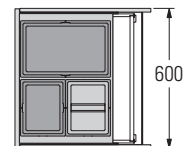
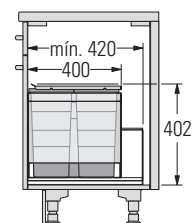

## Triple XL 800 28+28+18L

Abertura automática.  
 Instalado no fundo de qualquer gaveta standard.  
 Ajustável a ilhargas de 16-19 mm.  
 Laterais do balde cobrem as corredeiras da gaveta.  
 Prateleira de chapa metálica montada na ilharga.  
 Profundidade mínima da gaveta: 420 mm.  
 Volume de 74L (2 x 28L + 18L).



Compatível com mecanismo Libero



Mód.



P (mm)



A (mm)



V (L)



Acab.

Código

80

400/420

402

74

Cinza escuro

H.TX3631881

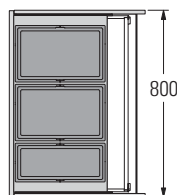
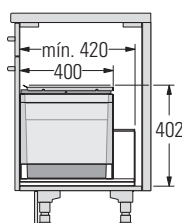

## Triple XL 900 28+28+28L

Abertura automática.  
 Instalado no fundo de qualquer gaveta standard.  
 Ajustável a ilhargas de 16-19 mm.  
 Laterais do balde cobrem as corredeiras da gaveta.  
 Prateleira de chapa metálica montada na ilharga.  
 Profundidade mínima da gaveta: 420 mm.  
 Volume de 84L (3 x 28L).



Compatível com mecanismo Libero



Mód.



P (mm)



A (mm)



V (L)



Acab.

Código

90

400/420

402

84

Cinza escuro

H.TX3631981

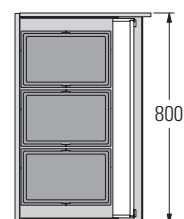
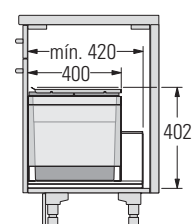

# AS XXL

Abertura automática.

Instalado no fundo de qualquer gaveta standard.

Ajustável a ilhargas de 16-19 mm.

Com depósito(s) para utensílios e/ou cesto(s) para artigos de limpeza.

Tampa para balde de 18L.

450	18 + 12 L
500	12 + 8,5 + 8,5 L
600	18 + 8,5 + 8,5 L
800	18 + 18 + 12 L
900	18 + 18 + 12 + 12 L

## AS XXL 450 18+12L D+P+U

Abertura automática.

Instalado no fundo de qualquer gaveta standard.

Ajustável a ilhargas de 16-19 mm.

Com 1 depósito para utensílios de 0,7L e 1 cesto para artigos de limpeza de 4,1L.

Com tampa para o balde de 18L.

Profundidade mínima da gaveta: 500 mm.

Volume de 30L (18L + 12L).



Compatível com mecanismo Libero



Mód.



P (mm)



A (mm)



V (L)



Acab.

Código

45	433	330	30	Cinza	H.XL3630451
----	-----	-----	----	-------	-------------

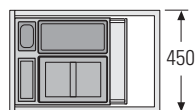
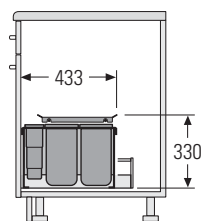

## AS XXL 500 12+8,5+8,5L D+2P

Abertura automática.

Instalado no fundo de qualquer gaveta standard.

Ajustável a ilhargas de 16-19 mm.

Com 2 cestos para artigos de limpeza de 4,1L cada.

Com tampa para o balde de 12L.

Profundidade mínima da gaveta: 500 mm.

Volume de 29L (12L + 8,5L + 8,5L).



Compatível com mecanismo Libero



Mód.



P (mm)



A (mm)



V (L)



Acab.

Código

50	433	330	29	Cinza	H.XL3630501
----	-----	-----	----	-------	-------------

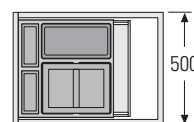
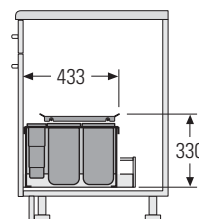



## AS XXL 600 18+8,5+8,5L D+2P

Abertura automática.  
 Instalado no fundo de qualquer gaveta standard.  
 Ajustável a ilhargas de 16-19 mm.  
 Com 2 cestos para artigos de limpeza de 4,1L cada.  
 Com tampa para o balde de 18L.  
 Profundidade mínima da gaveta: 500 mm.  
 Volume de 35L (18L + 8,5L + 8,5L).



Compatível com mecanismo Libero



Mód.



P (mm)



A (mm)



V (L)



Acab.

Código

60

433

330

35

Cinza

H.XL3630601

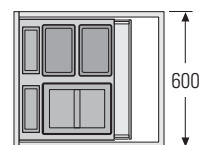
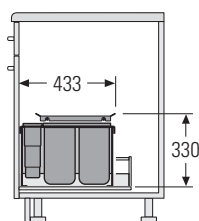

## AS XXL 800 18+18+12L 2D+2P

Abertura automática.  
 Instalado no fundo de qualquer gaveta standard.  
 Ajustável a ilhargas de 16-19 mm.  
 Com 3 cestos para artigos de limpeza de 4,1L cada.  
 Com tampas para os baldes de 18L.  
 Profundidade mínima da gaveta: 500 mm.  
 Volume de 48L (18L + 18L + 12L).



Compatível com mecanismo Libero



Mód.



P (mm)



A (mm)



V (L)



Acab.

Código

80

433

300

48

Cinza

H.XL3630801

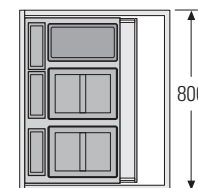
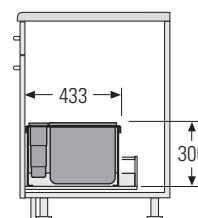

## AS XXL 900 18+18+12+12L 2D+2P+2U

Abertura automática.  
 Instalado no fundo de qualquer gaveta standard.  
 Ajustável a ilhargas de 16-19 mm.  
 Com 2 depósitos para utensílios de 0,7L cada e 2 cestos para artigos de limpeza de 4,1L cada.  
 Com tampas para os baldes de 18L.  
 Profundidade mínima da gaveta: 500 mm.  
 Volume de 60L (18L + 18L + 12L + 12L).



Compatível com mecanismo Libero



Mód.



P (mm)



A (mm)



V (L)



Acab.

Código

90

433

300

60

Cinza

H.XL3630901

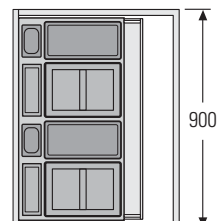
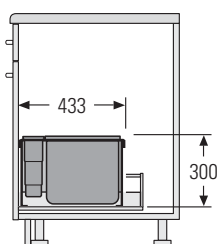

# CARGO SEPARATO

Abertura automática.

Para aplicação em gavetão médio ou alto. Gavetão não fornecido.

Não compatível com Blum Legra Box F.

Prateleira de plástico de extensão única.

Tampa para balde de 8L.

450	18 + 8 + 8 L
500	18 + 8 + 8 L
600	18 + 8 + 8 L
800	18 + 18 + 8 + 8 L

## Cargo Separato K 450 18+8+8L D

Abertura automática.

Para aplicação em gavetão médio ou alto.

Não compatível com Blum Legra Box F.

Prateleira de plástico de extensão única.

1 tampa de balde de 8L.

Volume de 34L (18L + 8L + 8L).



Compatível com mecanismo Libero

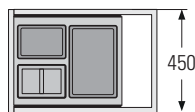
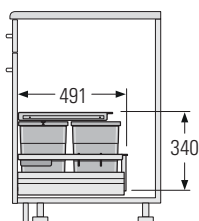

Mód.



L (mm)



P (mm)



A (mm)



V (L)



Acab.

Código

45	407	491	340	34	Cinza	H.SK3620461
----	-----	-----	-----	----	-------	-------------



## Cargo Separato K 500 18+8+8L D

Abertura automática.

Para aplicação em gavetão médio ou alto.

Não compatível com Blum Legra Box F.

Prateleira de plástico de extensão única.

1 tampa de balde de 8L.

Volume de 34L (18L + 8L + 8L).



Compatível com mecanismo Libero

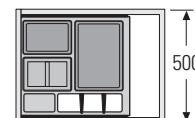
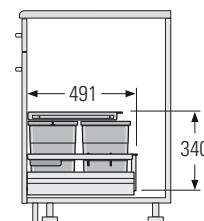

Mód.



L (mm)



P (mm)



A (mm)



V (L)



Acab.

Código

50	457	491	340	34	Cinza	H.SK3620511
----	-----	-----	-----	----	-------	-------------



## Cargo Separato K 600 18+8+8L D

Abertura automática.  
Para aplicação em gavetão médio ou alto.  
Não compatível com Blum Legra Box F.  
Prateleira de plástico de extensão única.  
1 tampa de balde de 8L.  
Volume de 34L (18L + 8L + 8L).

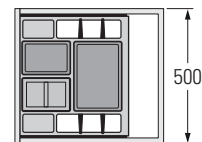
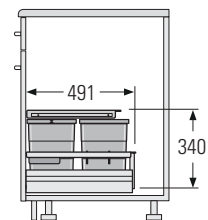

Compatível com mecanismo Libero



Mód.



L (mm)



P (mm)



A (mm)



V (L)



Acab.

Código

60

557

491

340

34

Cinza

H.SK3620611

## Cargo Separato K 900 18+18+8+8L D KS

Abertura automática.  
Para aplicação em gavetão médio ou alto.  
Não compatível com Blum Legra Box F.  
Prateleira de plástico.  
1 tampa de balde de 8L.  
Inclui escova e pá de pó.  
Volume de 52L (18L + 18L + 8L + 8L).

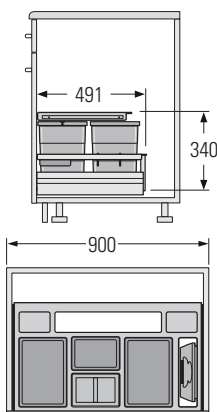

Mód.



L (mm)



P (mm)



A (mm)



V (L)



Acab.

Código

90

860

491

340

52

Cinza

H.SK3620911

Compatível com mecanismo Libero



# TANDEM

Modelos de extração total, outros parcial.  
Instalado no fundo do móvel.

300	15 + 15 L	24 + 7 L	24 L
400	15 + 15 L	18 + 18 L	20 + 20 L
500	18 + 12 L		

## Tandem 15+15L (3666)

Extração total.  
Montagem no fundo do móvel.  
Volume de 30L (15L + 15L).

Modelos incluem acessórios diferentes:

- Mód. 30 inclui tampa para um balde.
- Mód. 40 inclui escova e apanhador.

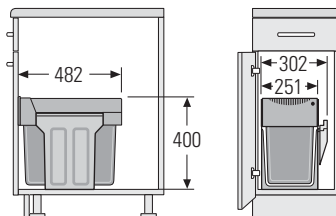

Mód.	L (mm)	P (mm)	A (mm)	V (L)	Acab.	Código
30	251	482	400	30	Cinza	H.T3666821
40	302	482	400	30	Cinza	H.T3666801



## Tandem 24+7L / 15+15L

Extração total.  
Montagem no fundo do móvel.  
Opção entre volume de:

- 31L (24L + 7L).
- 30L (2 x 15L).

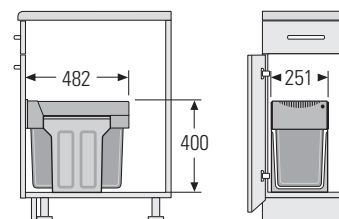

Mód.	L (mm)	P (mm)	A (mm)	V (L)	Acab.	Código
30	251	482	400	31	Cinza escuro	H.T3666111
30	251	482	400	30	Cinza escuro	H.T3666101



## Tandem 15+15L Black Edition

Extração total.  
Montagem no fundo do móvel.  
Volume de 30L (15L + 15L).

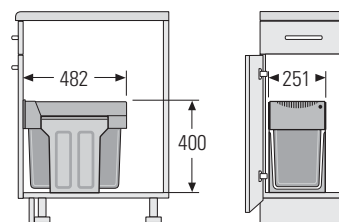

Mód.	L (mm)	P (mm)	A (mm)	V (L)	Acab.	Código
30	251	482	400	30	Preto	H.T366851

## Tandem 15+15L Anti-Bactérias

Extração total.  
Montagem no fundo do móvel.  
Menos 99.9 % bactérias nas superfícies plásticas: tampa, painel de abertura e baldes.  
Propriedade anti-bacteriana em plena ação por mais de 15 anos.  
Testado em mais de 50 tipos de bactérias.  
Volume de 30L (15L + 15L).

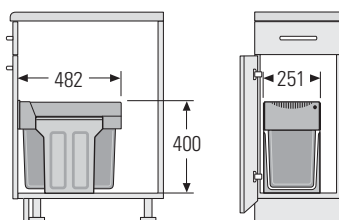

Mód.	L (mm)	P (mm)	A (mm)	V (L)	Acab.	Código
30	251	482	400	30	Anti-bactérias	H.T366661



## Tandem Single Box 24L

Extração total.  
Montagem no fundo do móvel.  
Volume de 24L (balde único).

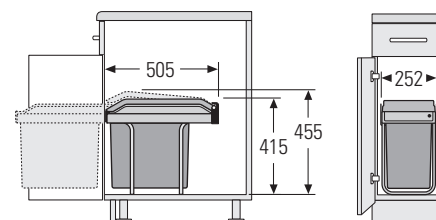

Mód.	L (mm)	P (mm)	A (mm)	V (L)	Acab.	Código
30	252	505	415/455	24	Cinza escuro	H.T3650241

## Tandem 15+15L (3650)

Extração parcial.  
Montagem no fundo do móvel.  
Volume de 30L (15L + 15L).

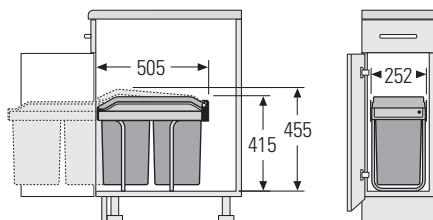

Mód.	L (mm)	P (mm)	A (mm)	V (L)	Acab.	Código
30	252	505	415/455	30	Cinza escuro	H.T3650101



## Space-Saving Tandem 18+18L

Extração total.  
Montagem no fundo do móvel.  
Volume de 36L (18L + 18L).

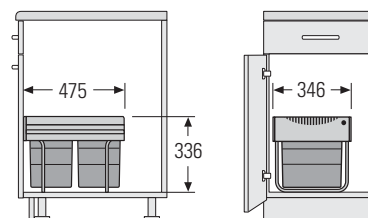

Mód.	L (mm)	P (mm)	A (mm)	V (L)	Acab.	Código
40	346	475	336	36	Cinza	H.ST3641121
40	346	475	336	36	Cinza escuro	H.ST3641521

## Space-Saving Tandem Comfort 20+20L KS

Extração total.  
Montagem no fundo do móvel.  
Inclui escova e apanhador.  
Volume de 40L (20L + 20L).

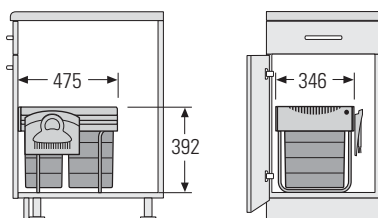

Mód.	L (mm)	P (mm)	A (mm)	V (L)	Acab.	Código
40	346	475	392	40	Cinza	H.ST3641221



## Space-Saving Tandem S 18+12L

Extração total.  
Montagem no fundo do móvel.  
Volume de 30L (18L + 12L).

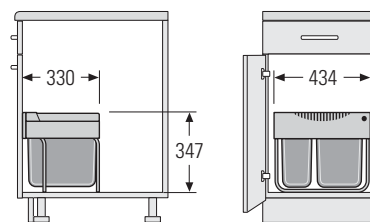

Mód.	L (mm)	P (mm)	A (mm)	V (L)	Acab.	Código
50	434	330	347	30	Cinza	H.ST3644701
50	434	330	347	30	Cinza escuro	H.ST3644901

# AS ALLEGRO

Sistema composto por um tapete anti-derrapante, os baldes e uma tampa extensível.  
Montado na ilharga, 16-19 mm.

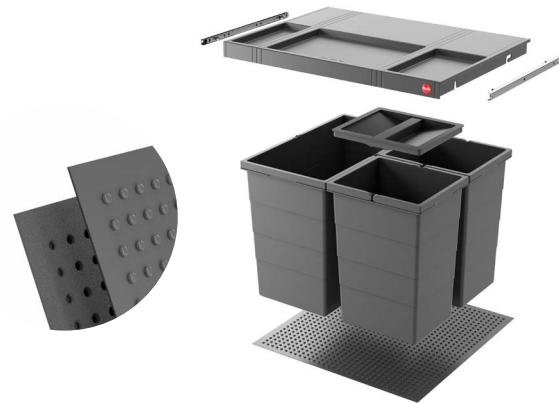

600	2 x 14 L	14 + 2 x 6,5 L	18 + 2 x 8 L
	2 x 18 L + 2 x 8 L	2 x 28 L	28 + 2 x 13 L
	2 x 28 L	28 + 2 x 13 L	

## AS Allegro 220 14/14

Volume de 28L (14L + 14L).  
Montado na ilharga, 16-19 mm.  
Tampa de plástico extensível montada na ilharga.

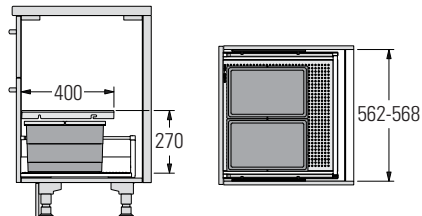

M	L	P	A	V	Acab.	Código
Mód.	L (mm)	P (mm)	A (mm)	V (L)		
60	476	473	270	28	Cinza escuro	H.A3301611

## AS Allegro 220 14/6,5/6,5/D

Volume de 27L (14L + 2 x 6,5L).  
Montado na ilharga, 16-19 mm.  
Tampa para balde de 6,5L.  
Tampa de plástico extensível montada na ilharga.

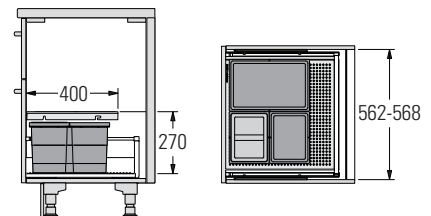

M	L	P	A	V	Acab.	Código
Mód.	L (mm)	P (mm)	A (mm)	V (L)		
60	476	473	270	27	Cinza escuro	H.A3301621



## AS Allegro 295 18/8/8/D



Volume de 34L (18L + 2 x 8L).  
Montado na ilharga, 16-19 mm.  
Tampa para balde de 8L.  
Tampa de plástico extensível  
montada na ilharga.

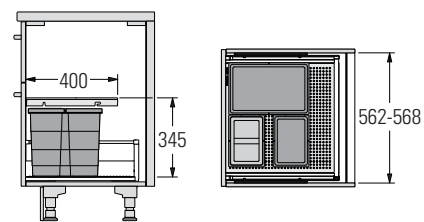

Mód.	L (mm)	P (mm)	A (mm)	V (L)	Acab.	Código
60	476	473	345	34	Cinza escuro	H.A3301631

## AS Allegro 295 18/18/8/8/D

Volume de 52L (2 x 18L + 2 x 8L).  
Montado na ilharga, 16-19 mm.  
Tampa para balde de 8L.  
Tampa de plástico extensível  
montada na ilharga.

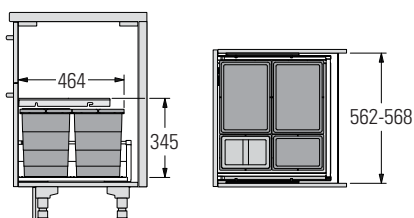

Mód.	L (mm)	P (mm)	A (mm)	V (L)	Acab.	Código
60	476	473	345	52	Cinza escuro	H.A3301641

## AS Allegro 350 28/28



Volume de 56L (2 x 28L).  
Montado na ilharga, 16-19 mm.  
Tampa de plástico extensível  
montada na ilharga.

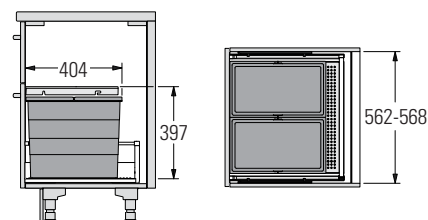

Mód.	L (mm)	P (mm)	A (mm)	V (L)	Acab.	Código
60	476	473	397	56	Cinza escuro	H.A3301651

## AS Allegro 350 28/13/13/D

Volume de 54L (28L + 2 x 13L).  
 Montado na ilharga, 16-19 mm.  
 Tampa para balde de 13L.  
 Tampa de plástico extensível  
 montada na ilharga.

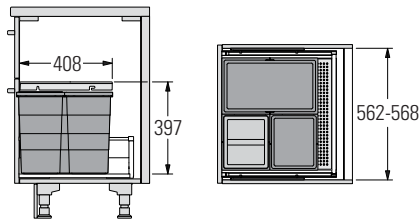

Mód.	L (mm)	P (mm)	A (mm)	V (L)	Acab.	Código
60	476	473	397	54	Cinza escuro	H.A3301661

## AS Allegro 380 28/28

Volume de 56L (2 x 28L).  
 Montado na ilharga, 16-19 mm.  
 Tampa de plástico extensível  
 montada na ilharga.

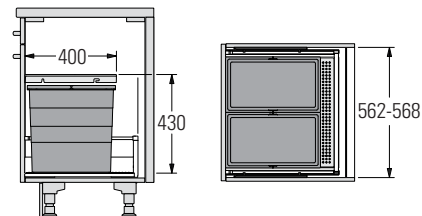

Mód.	L (mm)	P (mm)	A (mm)	V (L)	Acab.	Código
60	476	473	430	56	Cinza escuro	H.A3301671

## AS Allegro 380 28/13/13/D

Volume de 54L (28L + 2 x 13L).  
 Montado na ilharga, 16-19 mm.  
 Tampa para balde de 13L.  
 Tampa de plástico extensível  
 montada na ilharga.

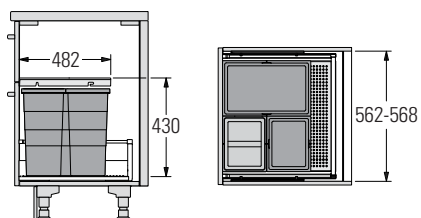

Mód.	L (mm)	P (mm)	A (mm)	V (L)	Acab.	Código
60	476	473	430	54	Cinza escuro	H.A3301681

# EASY CARGO

Extração total.  
Unidade integrada na prateleira.  
Montagem no fundo do móvel.

400 42 L

500 30 + 19 L

## Easy Cargo 42L

Extração total.  
Unidade integrada na prateleira.  
Montagem no fundo do móvel.  
Volume de 42L (balde único).

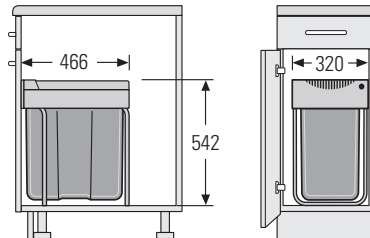

Mód.	L (mm)	P (mm)	A (mm)	V (L)	Acab.	Código
40	320	466	542	42	Cinza	H.E3668401



## Easy Cargo 30+19L

Extração total.  
Montagem no fundo do móvel.  
Volume de 49L (30L + 19L).

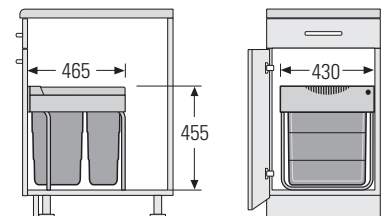

Mód.	L (mm)	P (mm)	A (mm)	V (L)	Acab.	Código
50	430	465	455	49	Cinza	H.E3668501

# INSTALAÇÃO NA GAVETA

Abertura automática.

Instalação dentro de gaveta disponível. Gaveta não fornecida.

Prateleira de plástico.

300

38 + 7 L

15 + 15 L



## Euro Cargo 300 38+7L

Abertura automática.

Instalação dentro de gaveta disponível.

Prateleira de plástico.

Volume de 45L (38L + 7L).

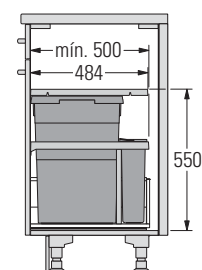

Mód.



L (mm)



P (mm)



A (mm)



V (L)



Acab.

Código

30

259

484/500

550

45

Cinza escuro

H.EC3669101

## AS Tandem 300 15+15L

Abertura automática.

Instalação dentro de gaveta disponível.

Prateleira de plástico.

Volume de 30L (2 x 15L).

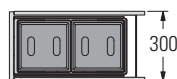
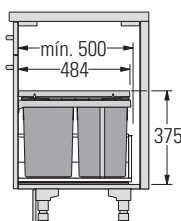

Mód.



L (mm)



P (mm)



A (mm)



V (L)



Acab.

Código

30

259

484

375

30

Cinza escuro

H.T3669001

# SOLO

Extração total.  
Montagem no fundo do móvel.

300 20 L

400 20 L



## Solo 20L

Extração total.  
Montagem no fundo do móvel.  
Volume de 20L (balde único).

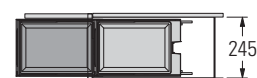
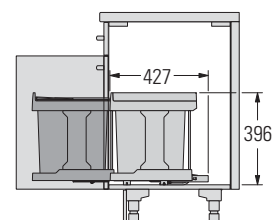

Mód.	L (mm)	P (mm)	A (mm)	V (L)	Acab.	Código
30	245	427	396	20	Cinza escuro	H.S3635001

## Solo 20L com Abertura Automática

Abertura com acompanhamento da porta automático.  
Extração total.  
Montagem no fundo do móvel.  
Volume de 20 (balde único).

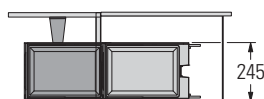
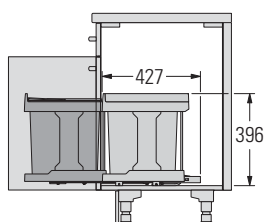

Mód.	L (mm)	P (mm)	A (mm)	V (L)	Acab.	Código
40	245	427	396	20	Cinza escuro	H.S3636001



# BIG BOX

Montado na ilharga.

Elevação da tampa automática, com mecanismo de mola.

Não é apropriado combinar a aplicação do produto com dobradiças amortecidas.

400 15 L 20 L



## Big Box 15L

Não é apropriado combinar a aplicação do produto com dobradiças amortecidas.

Montado na ilharga.

Elevação da tampa automática, com mecanismo de mola.

Volume de 15L (balde único).

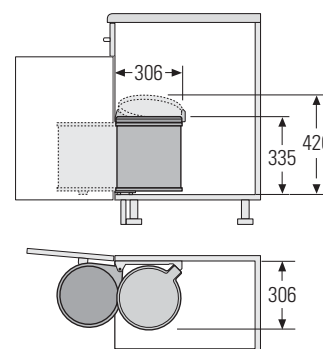

Mód.	D (mm)	A (mm)	V (L)	Acabamento		Código
				Corpo	Tampa	
40	306	335/420	15	Prata	Preto	H.BB3715211
40	306	335/420	15	Inox	Castanho	H.BB3715101
40	306	335/420	15	Inox	Branco	H.BB3715191

## Big Box 20L

Não é apropriado combinar a aplicação do produto com dobradiças amortecidas.

Montado na ilharga.

Elevação da tampa automática, com mecanismo de mola.

Volume de 20L (balde único).

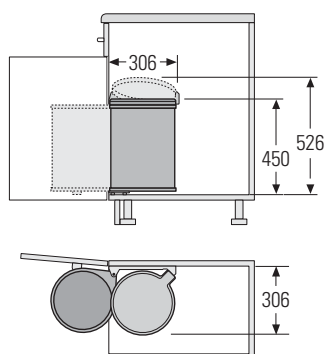

Mód.	D (mm)	A (mm)	V (L)	Acabamento		Código
				Corpo	Tampa	
40	306	450/526	20	Cinza	Preto	H.BB3720211
40	306	450/526	20	Inox	Castanho	H.BB3720101

# MONO

Viragem e inclinação da tampa sem mola.  
Montado na ilharga.

400

15 L

12 L



## Mono 15L

Viragem e inclinação da tampa sem mola.  
Montado na ilharga.  
Volume de 15L (balde único).

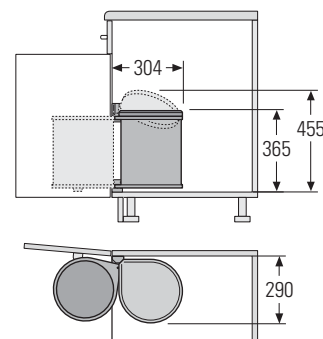

Mód.	L (mm)	P (mm)	A (mm)	V (L)	Acabamento		Código
					Corpo	Tampa	
40	290	304	365/455	15	Branco	Branco	H.M3515001
40	290	304	365/455	15	Antracite	Preto	H.M3515071
40	290	304	365/455	15	Inox	Branco	H.M3515011
40	290	304	365/455	15	Inox	Preto	H.M3515031

## Mono 12L

Viragem e inclinação da tampa sem mola.  
Montado na ilharga.  
Volume de 12L (balde único).

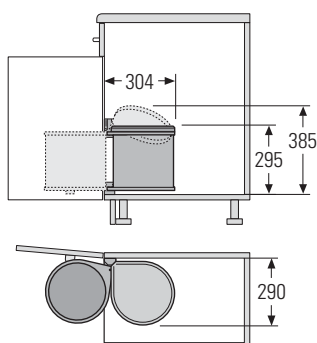

Mód.	L (mm)	P (mm)	A (mm)	V (L)	Acabamento		Código
					Corpo	Tampa	
40	290	304	295/385	12	Branco	Branco	H.M3512001
40	290	304	295/385	12	Inox	Preto	H.M3512031
40	290	304	295/385	12	Inox	Branco	H.M3512011



# OUTROS

Baldes diversos.

450 18 L variável

## Uno 18L

Tampa com mecanismo de virar e inclinar.  
Montado na ilharga.  
Volume de 18L (balde único).

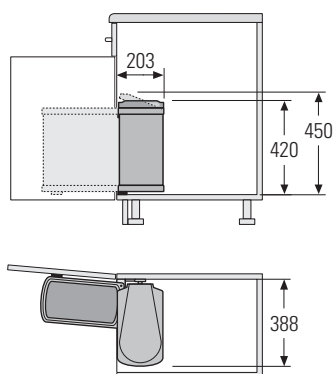

Mód.	L (mm)	P (mm)	A (mm)	V (L)	Acab.	Código
45	388	203	420/450	18	Aço inoxidável	H.U3418101



## Balde Depot

Porta-sacos de lavanderia.  
Suporte de parede e tampa em chapa de metal.  
Com dispositivo de fixação para sacos de plástico ou sacos de tecido de algodão.  
Fornecido com saco de algodão.  
Para aplicar na ilharga lateral.

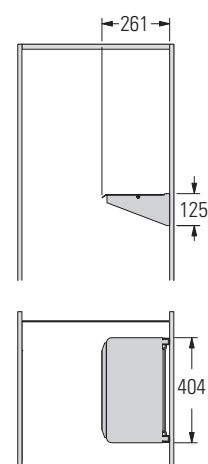

L (mm)	P (mm)	A (mm)	Acab.	Código
404	261	125	Lacado branco	H.D3272111





## Acessório



### Libero Mecanismo eletrónico de abertura de portas

- Sensor na área do plinto para fácil operação com o pé.
- Sistema de abertura para todos os tipos de extensões, gavetas de abertura amortecida, ou baldes-de-lixo no fundo da gaveta.
- Força de push-out ajustável (5 configurações para qualquer tipo de correção).
- Soft-closing dos sistemas de reciclagem.
- Instalação fácil, em poucos minutos, sem ferramentas ou acessórios especiais.
- Plug-and-Play, 230 V ( $\pm 10\%$ ), 50-60 Hz, tomada de alimentação Europeu de 2 pinos.

 L (mm)	 P (mm)	 A (mm)	Código
216	176	42	H.3697101

