

AGOFORN®

furnital

Gollinucci



PORTA-TALHERES E PORTA-PRATOS

CASATREND



Trend

AGOFORN®

Material resistente ao choque (poliestireno) de 2,5 mm de espessura. Profundidade de 480 mm, com corte mínimo de 435 mm.

Módulo	L (mm)	P (mm)	A (mm)	Acabamento	
				Cinza	Antracite
30	200-240	435-480	43	PT.T.30C	–
35	250-290	435-480	43	PT.T.35C	–
40	300-340	435-480	43	PT.T.40C	PT.T.40A
45	350-390	435-480	43	PT.T.45C	PT.T.45A
50	400-440	435-480	43	PT.T.50C	PT.T.50A
55	450-490	435-480	43	PT.T.55C	PT.T.55A
60	500-540	435-480	43	PT.T.60C	PT.T.60A
70	600-640	435-480	43	PT.T.70C	PT.T.70A
80	700-740	435-480	43	PT.T.80C	PT.T.80A
90	800-840	435-480	43	PT.T.90C	PT.T.90A
100	900-940	435-480	43	PT.T.100C	PT.T.100A
110	1000-1040	435-480	43	PT.T.110C	–
120	1100-1140	435-480	43	PT.T.120C	PT.T.120A

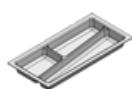

Mód. 30

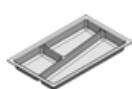

Mód. 35

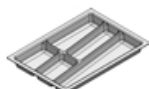

Mód. 40

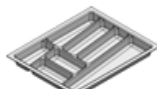

Mód. 45

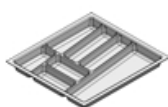

Mód. 50

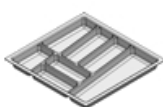

Mód. 55

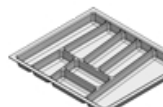

Mód. 60

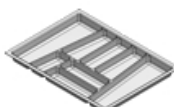

Mód. 70

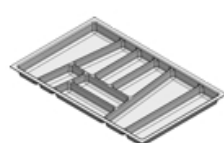

Mód. 80

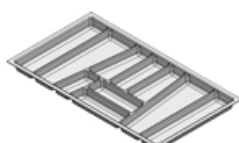

Mód. 90

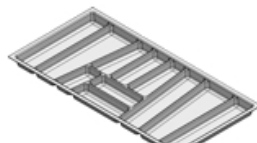

Mód. 100



Mód. 110

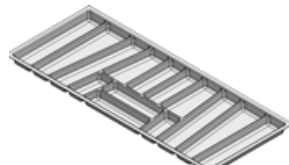

Mód. 120



Scoop II

AGOFORN®

Material resistente ao choque (poliestireno) de 2,5 mm de espessura.
Secções multi-propósito com divisores amovíveis.
Profundidade de 490 mm, com corte mínimo de 440 mm.

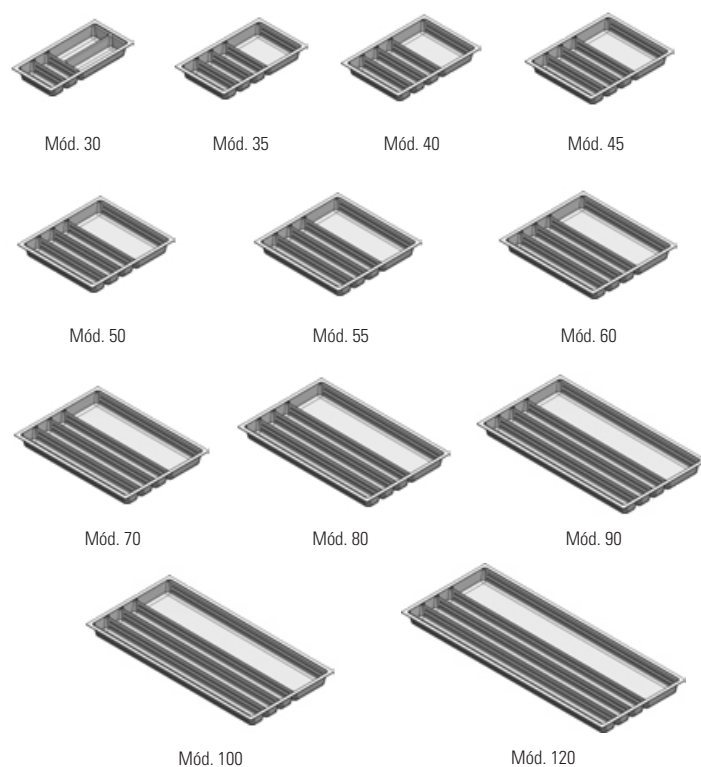

Módulo	L (mm)	P (mm)	A (mm)	Acab.	Código
30	200-240	440-490	57,5	Cinza	PT.S.30C
35	250-290	440-490	57,5	Cinza	PT.S.35C
40	300-340	440-490	57,5	Cinza	PT.S.40C
45	350-390	440-490	57,5	Cinza	PT.S.45C
50	400-440	440-490	57,5	Cinza	PT.S.50C
55	450-490	440-490	57,5	Cinza	PT.S.55C
60	500-540	440-490	57,5	Cinza	PT.S.60C
70	600-640	440-490	57,5	Cinza	PT.S.70C
80	700-740	440-490	57,5	Cinza	PT.S.80C
90	800-840	440-490	57,5	Cinza	PT.S.90C
100	900-940	440-490	57,5	Cinza	PT.S.100C
120	1100-1140	440-490	57,5	Cinza	PT.S.120C



Kit Divisor para Scoop II

3 peças pequenas e 1 peça grande.



Acab. Código

Cinza PT.S.D.C



Classicco

AGOFORN®



Mód. 30/35

Mód. 40

Mód. 45



Mód. 50

Mód. 55

Mód. 60

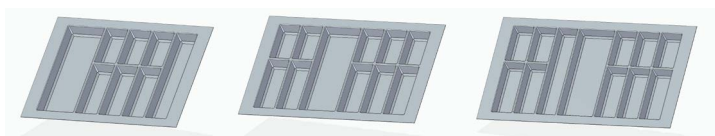

Mód. 70

Mód. 80

Mód. 90

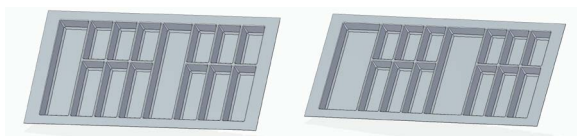

Mód. 100

Mód. 110

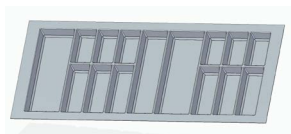

Mód. 120



Módulo	L (mm)	P (mm)	A (mm)	Acabamento	
				Cinza	Antracite
30/35	190-290	455-490	50,5	PT.C.30/35C	PT.C.30/35A
40	290-340	455-490	50,5	PT.C.40C	PT.C.40A
45	340-390	455-490	50,5	PT.C.45C	PT.C.45A
50	390-440	455-490	50,5	PT.C.50C	PT.C.50A
55	440-490	455-490	50,5	PT.C.55C	PT.C.55A
60	490-550	455-490	50,5	PT.C.60C	PT.C.60A
70	590-650	455-490	50,5	PT.C.70C	PT.C.70A
80	690-750	455-490	50,5	PT.C.80C	PT.C.80A
90	790-850	455-490	50,5	PT.C.90C	PT.C.90A
100	890-950	455-490	50,5	PT.C.100C	PT.C.100A
110	990-1050	455-490	50,5	PT.C.110C	PT.C.110A
120	1090-1150	455-490	50,5	PT.C.120C	PT.C.120A



Classic

Gollinucci

Mód.	L (mm)	P (mm)	Cinza	Acabamento	
				Branco	Antracite
30	200-251	390-490	PT.770.30C	PT.770.30B	PT.770.30A
40	297-351	390-490	PT.772.40C	PT.772.40B	PT.772.40A
45	347-401	390-490	PT.773.45C	PT.773.45B	PT.773.45A
50	397-451	390-490	PT.774.50C	PT.774.50B	PT.774.50A
60	497-551	390-490	PT.776.60C	PT.776.60B	PT.776.60A
80	697-740	390-490	PT.778.80C	PT.778.80B	PT.778.80A
90	795-840	390-490	PT.780.90C	PT.780.90B	PT.780.90A
100	895-940	390-490	PT.781.100C	PT.781.100B	PT.781.100A
120	1095-1140	390-490	PT.783.120C	PT.783.120B	PT.783.120A



Mód. 30



Mód. 40



Mód. 45



Mód. 50



Mód. 60



Mód. 80



Mód. 90



Mód. 100

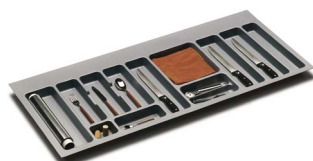

Mód. 120



Tábua, Porta Facas e Dispensador de Papel Filme para Classic

Artigo	Acab.	Aplicável a Módulos	Código
Tábua	Madeira	80-120	PT.791TM
Porta Facas	Madeira	50-120	PT.794PF
Dispensador Papel Filme	Aço	50-120	PT.795PR



Mód. 20



Mód. 30



Mód. 35



Mód. 40



Mód. 45



Mód. 50



Mód. 60



Mód. 70



Mód. 80



Mód. 90

Techno

Módulo	L (mm)	P (mm)	A (mm)	Acabamento		
				Antracite	Branco	Cinza
20	—	473	45	PT.TECH.20.A	PT.TECH.20.B	PT.TECH.20.C
30	224	473	45	PT.TECH.30.A	PT.TECH.30.B	PT.TECH.30.C
35	274	473	45	PT.TECH.35.A	PT.TECH.35.B	PT.TECH.35.C
40	324	473	45	PT.TECH.40.A	PT.TECH.40.B	PT.TECH.40.C
45	374	473	45	PT.TECH.45.A	PT.TECH.45.B	PT.TECH.45.C
50	424	473	45	PT.TECH.50.A	PT.TECH.50.B	PT.TECH.50.C
60	524	473	45	PT.TECH.60.A	PT.TECH.60.B	PT.TECH.60.C
70	624	473	45	PT.TECH.70.A	PT.TECH.70.B	PT.TECH.70.C
80	724	473	45	PT.TECH.80.A	PT.TECH.80.B	PT.TECH.80.C
90	824	473	45	PT.TECH.90.A	PT.TECH.90.B	PT.TECH.90.C



União

Permite combinar o porta-talheres de módulo 20 com outro de qualquer medida. Por exemplo, permite fazer as seguintes combinações:

- Mód. 80 + Mód. 20 + União = Mód. 100
 - Mód. 80 + 2 x Mód. 20 + 2 x União = Mód. 120
- Embalagem de 20 unidades.

Acabamento		
Antracite	Branco	Cinza
PT.TECH.U.A	PT.TECH.U.A	PT.TECH.U.C



Antracite



Branco



Cinza



Combi

Gollinucci

Modelos com aba numa das laterais, para que o porta-talheres seja inserido numa lateral da gaveta, à exceção do modelo 712, com abas em ambos os lados para ser colocado no centro da gaveta. Acessórios (vendidos à parte) aplicáveis aos modelos 714 e 715.

Modelo	L (mm)	P (mm)	A (mm)	Acab.	Código
710	266	420-490	45	Antracite	PT.710A
712	278	420-490	45	Antracite	PT.712A
714	376	420-490	45	Antracite	PT.714A
715	240	420-490	45	Antracite	PT.715A

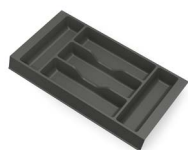

Mod. 710



Mod. 712



Mod. 714



Mod. 715



Porta Facas e Tábua para Combi

Para modelos 714 e 715.

Artigo	Acab.	Código
Porta Facas	Madeira de faia	PT.716PF
Tábua	Acrílico	PT.717TA



Connect

Sistema modular, unidos com conectores, para flexibilidade na organização da gaveta. Pode ser usado em qualquer gaveta.



Profundidade ajustável.

Porta-Talheres até 529 mm Ajustável

L (mm)	P (mm)	A (mm)	Acab.	Código
--------	--------	--------	-------	--------

275	529	50	Antracite	PT.CO.AJ
-----	-----	----	-----------	----------



Porta-Talheres 40/20 com 3 Divisões

L (mm)	P (mm)	A (mm)	Acab.	Código
--------	--------	--------	-------	--------

200	400	50	Antracite	PT.CO.40/20
-----	-----	----	-----------	-------------

Porta-Talheres 30/10 com 1 Divisão

L (mm)	P (mm)	A (mm)	Acab.	Código
--------	--------	--------	-------	--------

100	300	50	Antracite	PT.CO.30/10
-----	-----	----	-----------	-------------

Divisão em Forma de L

L (mm)	P (mm)	A (mm)	Acab.	Código
--------	--------	--------	-------	--------

100	250	50	Antracite	PT.CO.L
-----	-----	----	-----------	---------

Divisão em Forma de E

L (mm)	P (mm)	A (mm)	Acab.	Código
--------	--------	--------	-------	--------

100	200	50	Antracite	PT.CO.E
-----	-----	----	-----------	---------

Tapete Antideslizante Pearl

Módulo	L (mm)	P (mm)	Acab.	Código
--------	--------	--------	-------	--------

60	525	482	Preto	PT.CO.OPT60
----	-----	-----	-------	-------------

90	825	482	Preto	PT.CO.OPT90
----	-----	-----	-------	-------------

120	1125	482	Preto	PT.CO.OPT120
-----	------	-----	-------	--------------

Conector para União dos Elementos

L (mm)	P (mm)	A (mm)	Acab.	Código
--------	--------	--------	-------	--------

45	20	20	Vermelho	PT.CO.CUE
----	----	----	----------	-----------

Set A
Mód. 45-60



Set B
Mód. 50-60



Set C
Mód. 70-90



Set D
Mód. 80-90



Set E
Mód. 70-120

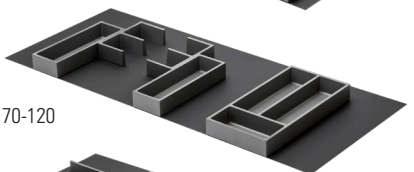

Set F
Mód. 100-120



2 unidades.



Pode ser cortado à medida da gaveta.



Set

	A	B	C	D	E	F
PT 40/20	1	1	2	2	1	2
PT 30/10	-	-	-	1	2	-
Divisão em L	-	1	-	1	-	2
Divisão em E	1	-	2	-	2	-
Conector	1	2	2	2	2	4

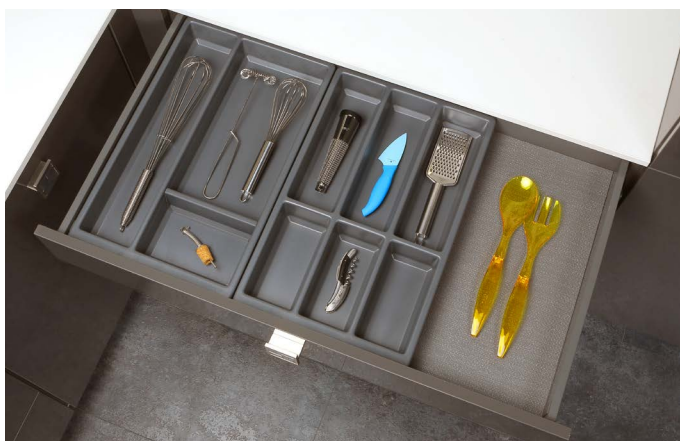

Island

O sistema Island é composto por 3 peças que podem ser combinados para caber em gavetas desde 500 mm até 1200 mm de largura.

Porta-Talheres



Com 6 divisões verticais.

L (mm)	P (mm)	A (mm)	Acab.	Código
300	480	49	Antracite	PT.I.PT

Porta-Especiarias



Com 33 ranhuras.

L (mm)	P (mm)	A (mm)	Acab.	Código
300	480	49	Antracite	PT.I.PE

Acessórios

Divisão Horizontal



Para aplicar no porta-utensílios.

L (mm)	P (mm)	A (mm)	Acab.	Código
166	10	30	Antracite	PT.I.D

Porta-Facas



Para aplicar no porta-utensílios.

L (mm)	P (mm)	A (mm)	Acab.	Código
166	433	30	Antracite	PT.I.PF

Porta-Utensílios



Com 2 divisões verticais.

L (mm)	P (mm)	A (mm)	Acab.	Código
300	480	49	Antracite	PT.I.PU

Tapete Antideslizante Slim

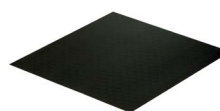

Módulo	L (mm)	P (mm)	Acab.	Código
60	525	482	Preto	PT.I.T60
90	825	482	Preto	PT.I.T90
120	1125	482	Preto	PT.I.T120



Open System

Sistema elegante que oferece flexibilidade na organização da gaveta.



Perfis para Gaveta

Para encaixe das divisões metálicas.
Conjunto de 2 perfis.



Módulo



L (mm)



Acab.

Código

xx

yy

Antracite

PT.G.OS.xx

Substituir xx por um dos módulos: 60, 90, 120.

Para obter a largura máxima (yy), subtrair 75 mm ao módulo.

Acessórios



Caixa de Madeira

Madeira de carvalho.



L (mm)



P (mm)



A (mm)



Acab.

Código

80

162

50

Madeira

PT.OS.CMS

80

298

50

Madeira

PT.OS.CML



Divisão Metálica



L (mm)



P (mm)



A (mm)



Acab.

Código

82

468

51

Antracite

PT.OS.D



Porta-Facas

Madeira de carvalho.



L (mm)



P (mm)



A (mm)



Acab.

Código

163

463

35

Madeira

PT.OS.PF



Tapete Antideslizante Pearl



Módulo



L (mm)



P (mm)



Acab.

Código

60

525

482

Preto

PT.CO.OPT60

90

825

482

Preto

PT.CO.OPT90

120

1125

482

Preto

PT.CO.OPT120



Porta-Especiarias

Madeira de carvalho.



L (mm)



P (mm)



A (mm)



Acab.

Código

163

463

35

Madeira

PT.OS.PE

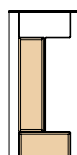

Set A
Mód. 30

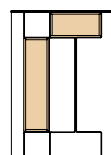

Set B
Mód. 40-45

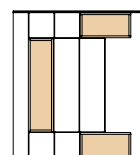

Set C
Mód. 50-60

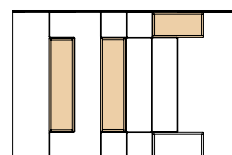

Set D
Mód. 70

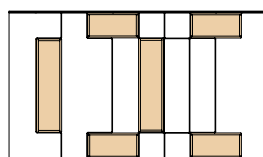

Set E
Mód. 80-90

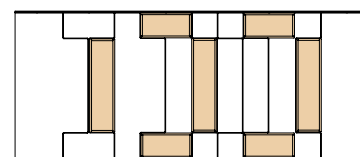

Set F
Mód. 120

	Set					
	A	B	C	D	E	F
Perfis	1	1	1	1	1	1
Divisão metálica	2	3	3	4	5	7
Caixa madeira L	1	1	1	2	2	3
Caixa madeira S	1	1	2	2	4	4

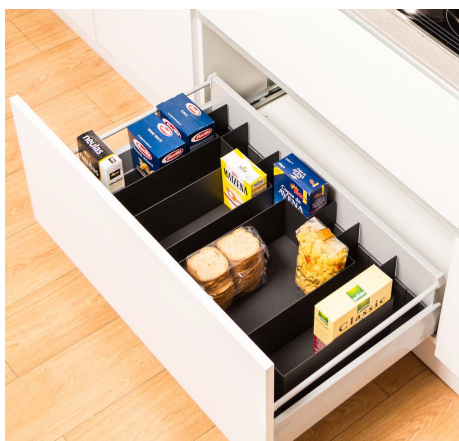

Open System para Gavetão

Sistema elegante que oferece flexibilidade na organização do gavetão.



Perfis para Gaveta

Para encaixe das divisões metálicas.
Conjunto de 2 perfis.

Módulo	L (mm)	Acab.	Código
xx	yy	Antracite	PT.G.OS.xx

Substituir xx por um dos módulos: 60, 90, 120.

Para obter a largura máxima (yy), subtrair 75 mm ao módulo.



Divisão Metálica

L (mm)	P (mm)	A (mm)	Acab.	Código
82	468	129	Antracite	PG.OS.D



Tapete Antideslizante Pearl

Módulo	L (mm)	P (mm)	Acab.	Código
60	525	482	Preto	PT.CO.OPT60
90	825	482	Preto	PT.CO.OPT90
120	1125	482	Preto	PT.CO.OPT120

Bambu

Módulo 120: 40-60 + 70-90.

Módulo	L (mm)	P (mm)	Acabamento	
			Bétula	Nogueira
40 / 60	305 / 525	473	PT.BAMBU.40.B	PT.BAMBU.40.N
70 / 90	605 / 825	473	PT.BAMBU.70.B	PT.BAMBU.70.N
100 / 110	905 / 1025	473	PT.BAMBU.100.B	PT.BAMBU.100.N



Mód. 40 / 60



Mód. 40 / 60



Mód. 70 / 90



Mód. 70 / 90



Mód. 100 / 110



Mód. 100 / 110



Bétula



Nogueira



Extensível

Customi

Porta-talheres ajustável em largura.

L (mm)	P (mm)	A (mm)	Acab.	Código
305 - 535	474	50	Madeira	CUSTOMI.60L500
512 - 950	474	50	Madeira	CUSTOMI.80L500

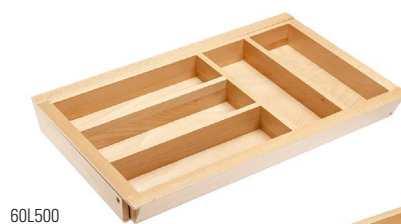

60L500



80L500

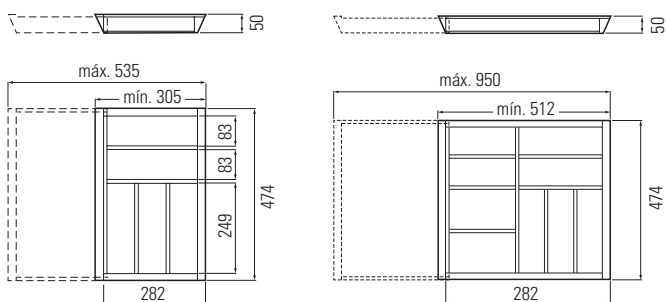

Organizador Belnet 472

Acessórios modulares para organização de gavetas de cozinha.

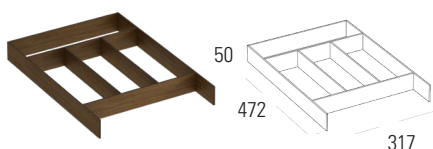

Porta-Talheres



Acab.

Código

Madeira	BN521.007.001
---------	---------------

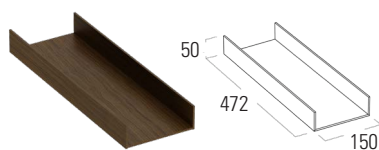

Tabuleiro Universal



Acab.

Código

Madeira	BN520.001.001
---------	---------------

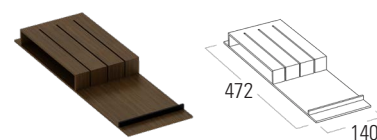

Porta-Facas



Acab.

Código

Madeira	BN521.003.001
---------	---------------

Preto	BN521.003.006
-------	---------------

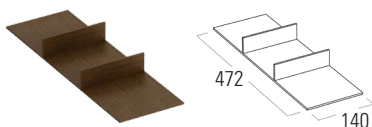

Divisor



Acab.

Código

Madeira	BN521.006.001
---------	---------------

Preto	BN521.006.006
-------	---------------

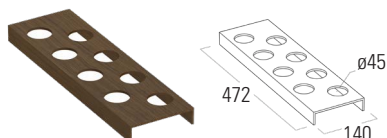

Porta-Especiarias Grande



Acab.

Código

Madeira	BN521.004.001
---------	---------------

Preto	BN521.002.004
-------	---------------

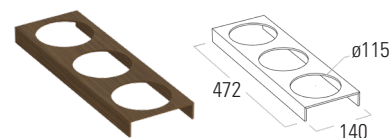

Porta-Garrafas



Acab.

Código

Madeira	BN521.001.002
---------	---------------

Preto	BN521.001.007
-------	---------------



Porta-Rolos



Acab.

Código

Preto	BN521.008.003
-------	---------------

Organizador Belnet Cuibus

Acessórios modulares para organização de gavetas de cozinha.

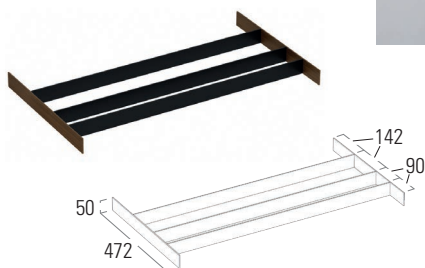

Grelha



Acab.	Módulo	Código
Madeira e preto	60	BN523.001.001
Madeira e preto	90	BN523.001.002
Madeira e preto	120	BN523.001.003

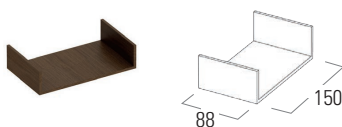

Tabuleiro pequeno



Acab.	Código
Madeira	BN523.003.002
Preto	BN523.003.006



Tabuleiro em U



Acab.	Código
Madeira	BN508.001.003
Preto	BN508.001.007

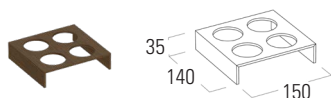

Porta-Especiarias Pequeno



Acab.	Código
Madeira	BN508.002.003
Preto	BN508.002.007

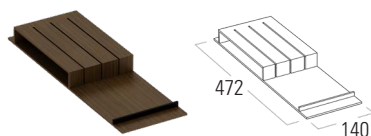

Porta-Facas



Acab.	Código
Madeira	BN521.003.001
Preto	BN521.003.006

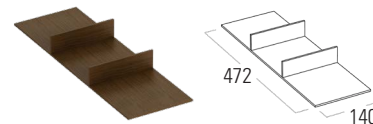

Divisor



Acab.	Código
Madeira	BN521.006.001
Preto	BN521.006.006

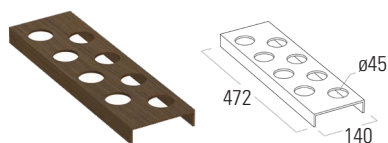

Porta-Especiarias Grande



Acab.	Código
Madeira	BN521.004.001
Preto	BN521.002.004

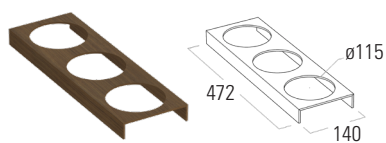

Porta-Garrafas



Acab.	Código
Madeira	BN521.001.002
Preto	BN521.001.007



Porta-Rolos



Acab.	Código
Preto	BN521.008.003



Bases Perfuradas de 8 e 16 mm



Faia



Nogueira

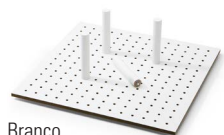

Branco

Base Perfurada de 8 mm

Módulo	L (mm)	P (mm)	A (mm)	Código
45	375	480	8	BP8.x.45
60	525	480	8	BP8.x.60
90	825	480	8	BP8.x.90
120	1125	480	8	BP8.x.120

Substituir x por um dos acabamentos: F = Faia, N = Nogueira e B = Branco.

Pivôs

Para base de 8 mm.
Conjunto de 4 pivôs.

A (mm)	Acab.	Código
135	Faia	PB8.Px



Base Perfurada de 16 mm

Pode substituir o fundo da gaveta ou ser posto sobre ele.

Módulo	L (mm)	P (mm)	A (mm)	Acab.	Código
45	400	500	16	Faia	BP16.45
60	600	500	16	Faia	BP16.60
90	850	500	16	Faia	BP16.90
120	1150	500	16	Faia	BP16.120

Pivô

Para base de 16 mm.
Vendido à unidade.

A (mm)	Acab.	Código
145	Faia	BP16.P



Porta-Garrafas

L (mm)	P (mm)	A (mm)	Acab.	Código
472	110	120	Faia	BP:PGP
481	110	120	Faia	BP:PGG



Porta-Frigideiras

Contém na base uma borracha antideslizante.

L (mm)	P (mm)	A (mm)	Acab.	Código
397	315	215	Faia	BP:PF



Porta-Pratos de Base Perfurada

A base perfurada pode substituir o fundo da gaveta, por ter uma espessura de 16 mm, ou ser posto sobre ele.

Base Perfurada



M					
Módulo	L (mm)	P (mm)	A (mm)	Acab.	Código
60	530	500	16	Faixa	BPG.60
90	830	500	16	Faixa	BPG.90
120	1130	500	16	Faixa	BPG.120

Pivô



Acab.	Código
Faixa	BPG.P

Porta-Pratos Regulável

Regulável em diâmetro.

D (mm)	P (mm)	A (mm)	Acab.	Código
265 - 410	160	175	Cinza	APPR

