



INTERIORES PARA ROUPEIRO

CASATREND | AMBOS

Cabide Lift

Aplicação lateral.
Largura extensível em 10 cm.

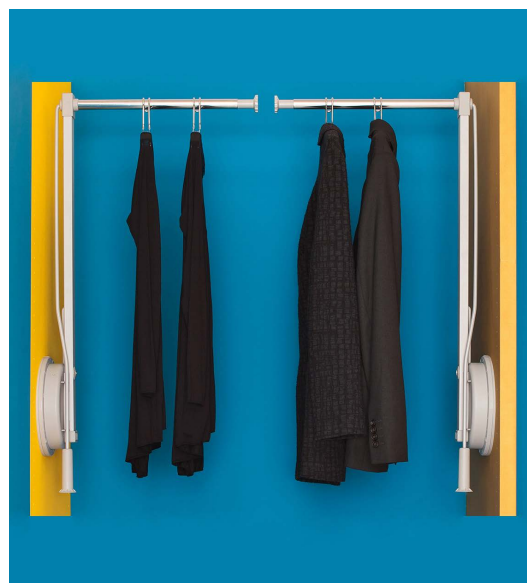
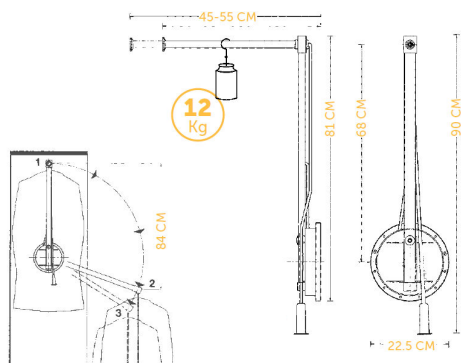

L (mm)



P (mm)



A (mm)



Cap. (kg)

Montagem

Esquerda

Direita

450-550

225

900

12

101A.LIFT.E

101A.LIFT.D

Distanciador para Cabide Lift



P (mm)

Código

20

103A.LIFT.DI

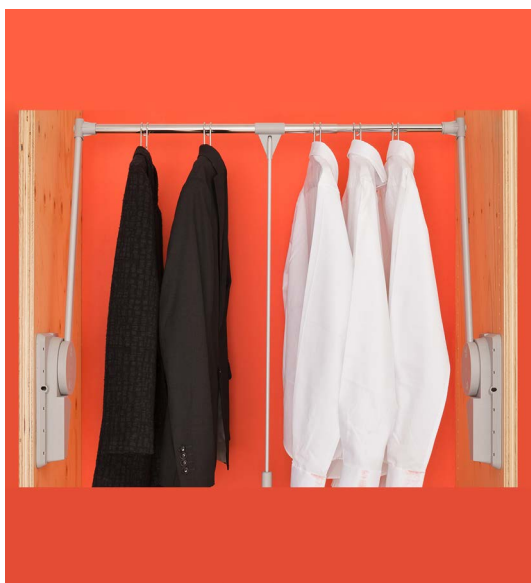
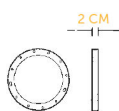

Cabide Super Lift

Regulação da verticalidade do braço.
Regulação da potência.
Possibilidade de aplicar à parede (com suporte vendido à parte).

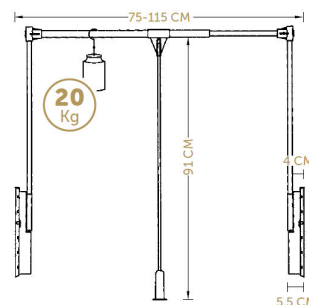

L (mm)



A (mm)



Cap. (kg)

Código

750-1150

910

14-20

151A.SLIFT

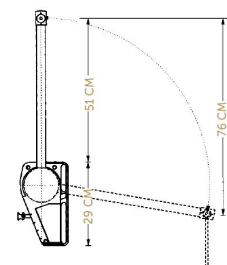

Acessórios para Cabide Super Lift

Artigo	L (mm)	A (mm)	Código
Distanciador	-	-	152A.SLIFT.DI
Suporte de parede	425	290	153A.SLIFT.SP

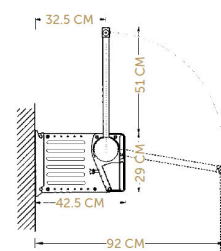



Cabide Lift 700

Forma que evita dobradiças.

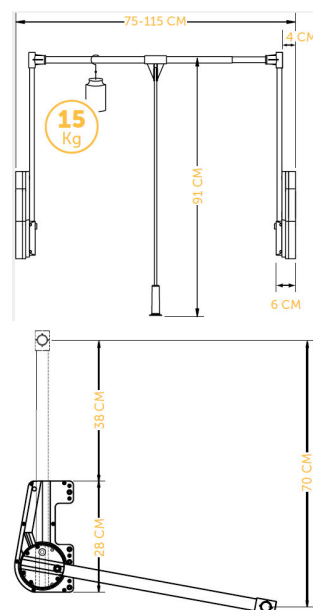

L (mm)	A (mm)	Cap. (kg)	Código
750-1150	910	15	700A.LIFT700

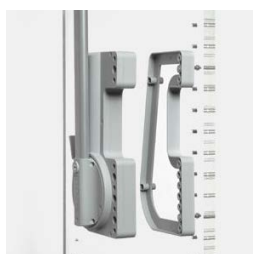

Distanciador para Cabide Lift 700

P (mm)	Código
20	701A.LIFT.DI

Trombone Cruzetas

Extensível em 31 cm.

4 ganchos com capacidade para 16 cruzetas.

P (mm)	Código
510	405A.TROMB

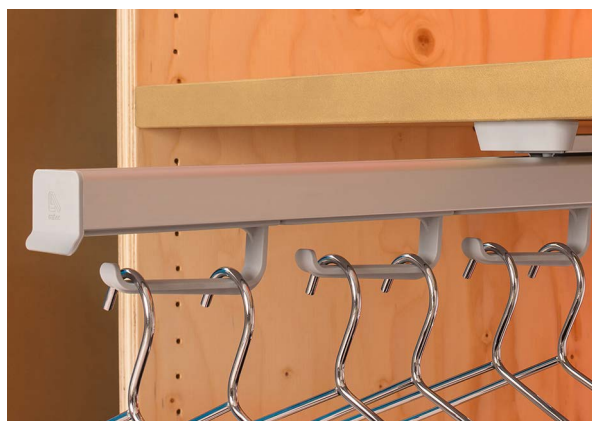
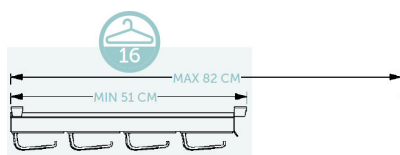

Calceiro Central

Extensível em 31 cm.

Capacidade para 10 calças.

L (mm)	P (mm)	Código
355	510	407A.PCALC

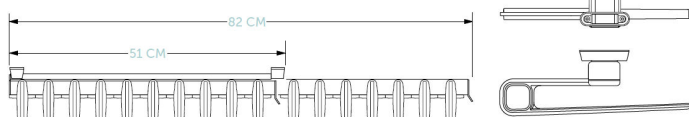



Calceiro Central Duplo

Extensível em 31 cm.
Capacidade para 20 calças.

L (mm)	P (mm)	Código
680	510	409A.PCALCD

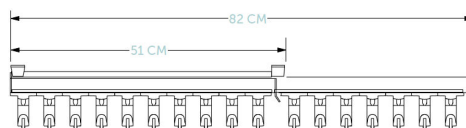
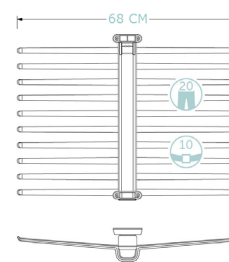

Porta-Calças

Extensível em 31 cm.
Fornecido com 12 cruzetas para até 24 calças.

L (mm)	P (mm)	A (mm)	Código
750-1150	510	110	402A.PCALC

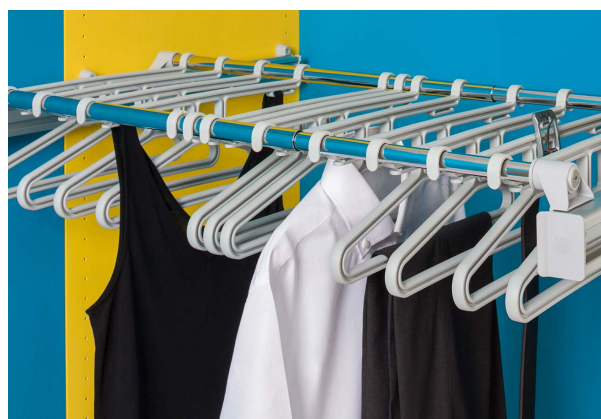
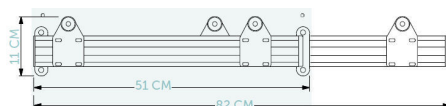
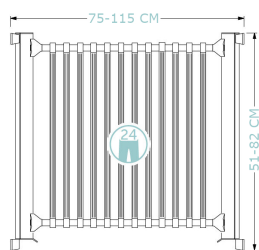

Porta-Cruzetas

Extensível em 31 cm.
Fornecido com 12 cruzetas para até 24 calças.

L (mm)	P (mm)	A (mm)	Código
750-1150	510	110	404A.PCRUZ

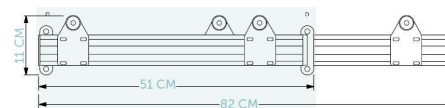
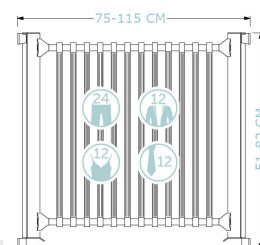

Porta-Gravatas

Extensível em 31 cm.
Capacidade para 19 gravatas.

P (mm)	A (mm)	Código
510	99	142A.PGRAV

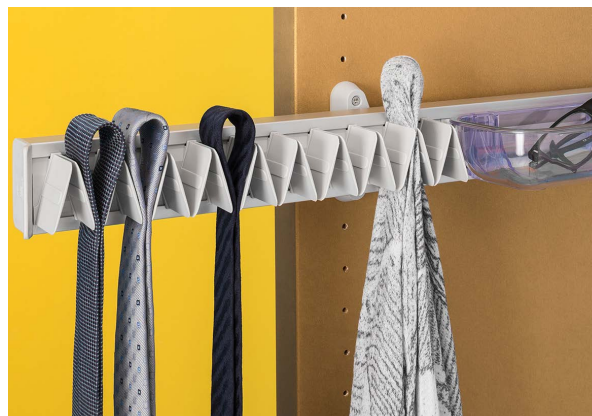
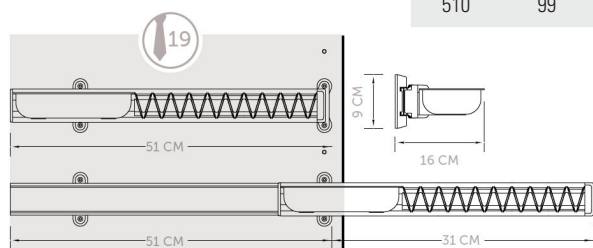

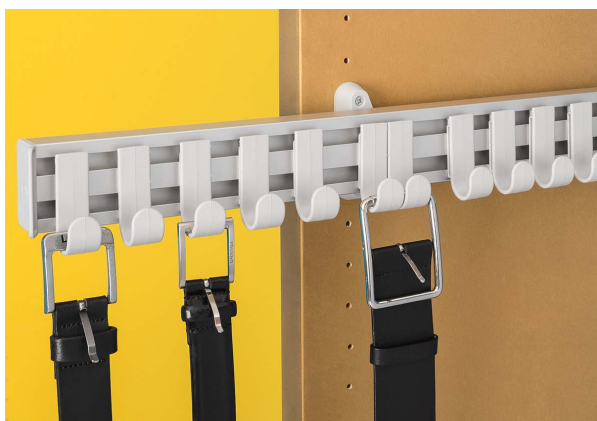

Porta-Cintos

Extensível em 31 cm.
Capacidade para 12 cintos.

P (mm)	A (mm)	Código
510	90	162A.PCINT

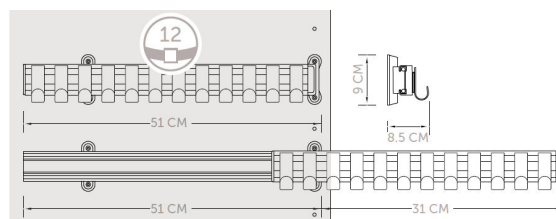

Sapateira Lateral

Fixação lateral.
Possibilidade de aplicação em guias de alumínio (vendido à parte)

L (mm)	P (mm)	A (mm)	Código
480-830	130	90	115A.SAPLP
830-1130	130	90	116A.SAPLG

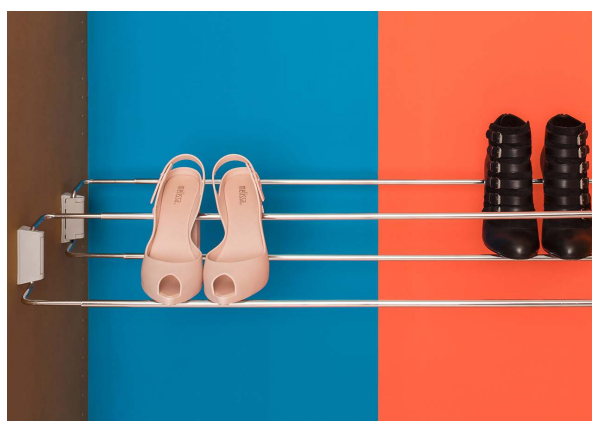
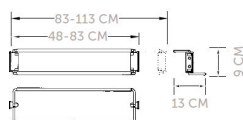

Sapateira Frontal

Fixação frontal.
Possibilidade de aplicação em guias de alumínio (vendido à parte)

L (mm)	P (mm)	A (mm)	Código
480-830	210	90	111A.SAPFP
830-1130	210	90	112A.SAPFG

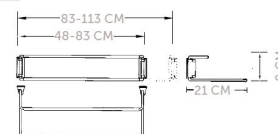

Guias de Alumínio para Sapateiras

Capacidade para 6 sapateiras laterais/
frontais.

L (mm)	P (mm)	A (mm)	Código
15	30	1120	117A.SAPGUIA

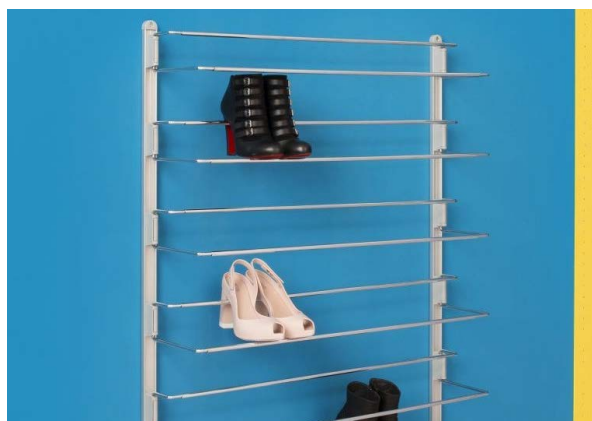
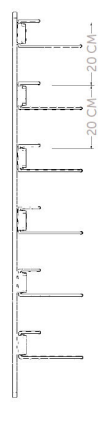
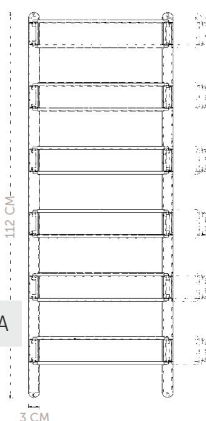



Suporte para Botas



L (mm)



P (mm)



A (mm)

Código

100

130

65

121A.SBOTAS

