



CEMUX

furnital

GTV



nexo|05



INTERIORES PARA ROUPEIRO
CASATREND | DIVERSOS



Porta-Calças Elite

Extensão total soft-close.

Módulo	L (mm)	Acabamento	
		Branco	Antracite
60	560-618	E.PC60B	E.PC60A
70	660-718	E.PC70B	E.PC70A
80	760-818	E.PC80B	E.PC80A
90	860-918	E.PC90B	E.PC90A

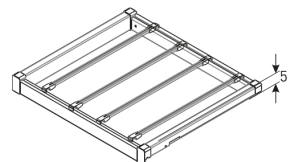
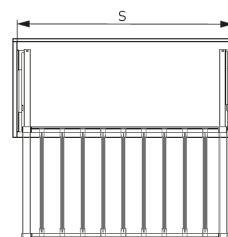

Varão para Porta-Calças

Sapateira em Arame Elite

Extensão total soft-close.

Módulo	L (mm)	Acabamento	
		Branco	Antracite
60	560-618	E.SA60B	E.SA60A
70	660-718	E.SA70B	E.SA70A
80	760-818	E.SA80B	E.SA80A
90	860-918	E.SA90B	E.SA90A

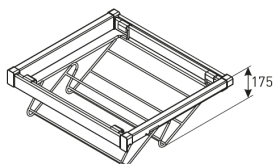
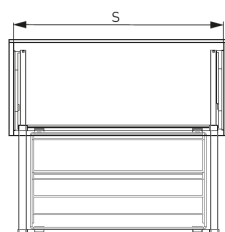

Sapateira Metálica Elite

Extensão total soft-close.

Módulo	L (mm)	Acabamento	
		Branco	Antracite
60	560-618	E.SM60B	E.SM60A
70	660-718	E.SM70B	E.SM70A
80	760-818	E.SM80B	E.SM80A
90	860-918	E.SM90B	E.SM90A

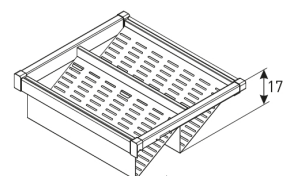
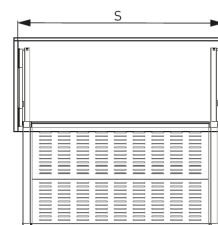

Cesto Baixo Metálico Elite

Extensão total soft-close.

Módulo	L (mm)	Acabamento	
		Branco	Antracite
60	560-618	E.CB60B	E.CB60A
70	660-718	E.CB70B	E.CB70A
80	760-818	E.CB80B	E.CB80A
90	860-918	E.CB90B	E.CB90A

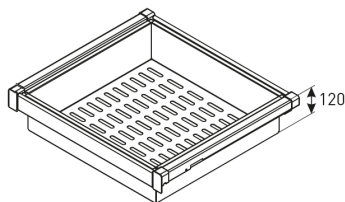
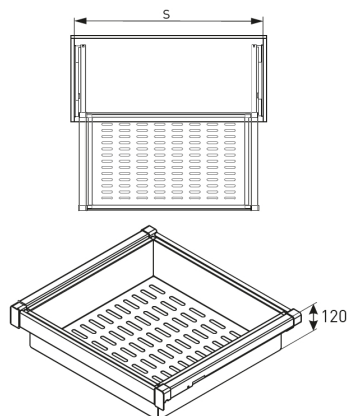

Cesto Alto em Arame Elite

Extensão total soft-close.

Módulo	L (mm)	Acabamento	
		Branco	Antracite
60	560-618	E.CA60B	E.CA60A
70	660-718	E.CA70B	E.CA70A
80	760-818	E.CA80B	E.CA80A
90	860-918	E.CA90B	E.CA90A

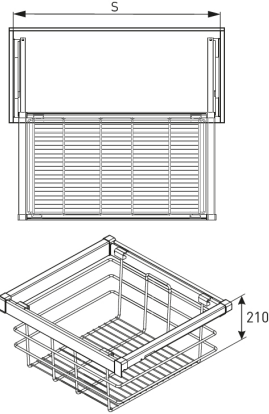

Organizador de Acessórios Elite

Extensão total soft-close.

Módulo	L (mm)	Acabamento	
		Branco	Antracite
60	560-618	E.O60B	E.O60A
70	660-718	E.O70B	E.O70A
80	760-818	E.O80B	E.O80A
90	860-918	E.O90B	E.O90A

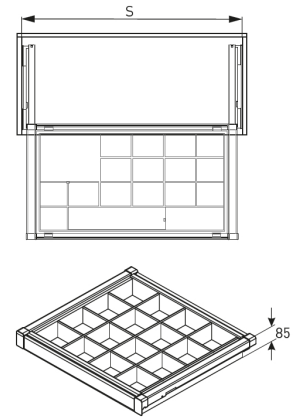

Cabide Extensível Elite

L (mm)	Cap. (kg)	Acabamento	
		Branco	Antracite
545-700	8	E.ERP B	E.ERPA
645-910	8	E.ERMB	E.ERMA
875-1200	8	E.ERGB	E.ERGA

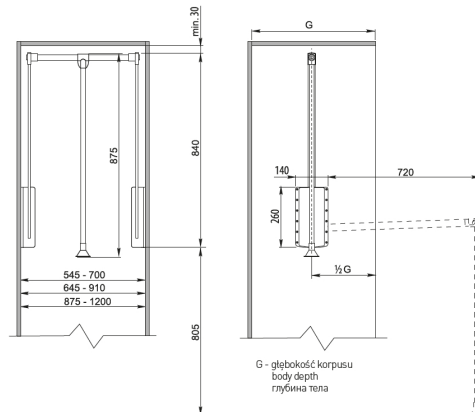

Série Quadro

Com possibilidade de montagem com frente.
Guias de 45cm.

Organizador de Acessórios Quadro

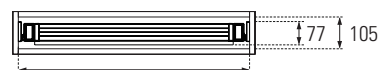
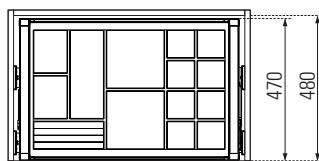

Mód. 600 - Mín. 564
Mód. 700 - Mín. 664
Mód. 800 - Mín. 764
Mód. 900 - Mín. 864
Extensível +50



Módulo

Acab.

60

70

80

90

Antracite

Q.060A

Q.070A

Q.080A

Q.090A

Moca

Q.060M

Q.070M

Q.080M

Q.090M

Cesto Multiusos Quadro

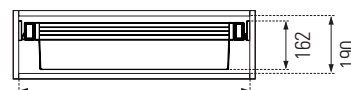
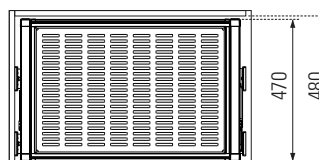

Mód. 600 - Mín. 564
Mód. 700 - Mín. 664
Mód. 800 - Mín. 764
Mód. 900 - Mín. 864
Extensível +50



Módulo

Acab.

60

70

80

90

Antracite

Q.CB60A

Q.CB70A

Q.CB80A

Q.CB90A

Moca

Q.CB60M

Q.CB70M

Q.CB80M

Q.CB90M

Sapateira Lux Quadro

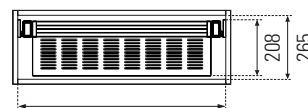
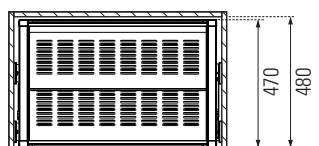

Mód. 600 - Mín. 564
Mód. 700 - Mín. 664
Mód. 800 - Mín. 764
Mód. 900 - Mín. 864
Extensível +50



Módulo

Acab.

60

70

80

90

Antracite

Q.SM60A

Q.SM70A

Q.SM80A

Q.SM90A

Moca

Q.SM60M

Q.SM70M

Q.SM80M

Q.SM90M

Sapateira Aramada Quadro

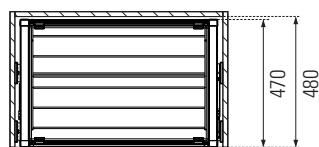

Mód. 600 - Mín. 564
Mód. 700 - Mín. 664
Mód. 800 - Mín. 764
Mód. 900 - Mín. 864
Extensível +50



Módulo

Acab.

60

70

80

90

Antracite

Q.SA60A

Q.SA70A

Q.SA80A

Q.SA90A

Moca

Q.SA60M

Q.SA70M

Q.SA80M

Q.SA90M

Calceiro Quadro

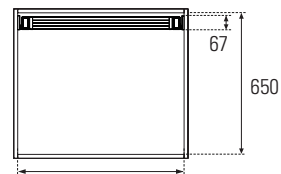
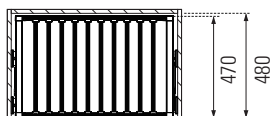

Mód. 600 - Mín. 564
 Mód. 700 - Mín. 664
 Mód. 800 - Mín. 764
 Mód. 900 - Mín. 864
 Extensível +50

Acab.	Módulo			
	60	70	80	90
Antracite	Q.PC60A	Q.PC70A	Q.PC80A	Q.PC90A
Moca	Q.PC60M	Q.PC70M	Q.PC80M	Q.PC90M

Cabide Lift



Aplicação lateral.
Largura extensível em 10 cm.

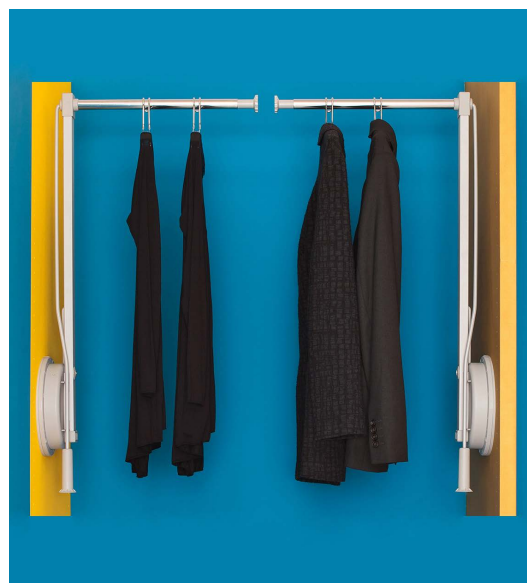
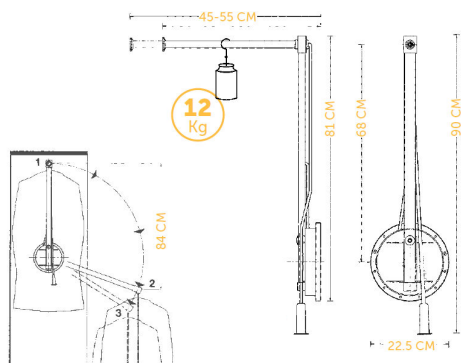

L (mm)



P (mm)



A (mm)



Cap. (kg)

Montagem

Esquerda

Direita

450-550

225

900

12

101A.LIFT.E

101A.LIFT.D

Distanciador para Cabide Lift



P (mm)

Código

20

103A.LIFT.DI

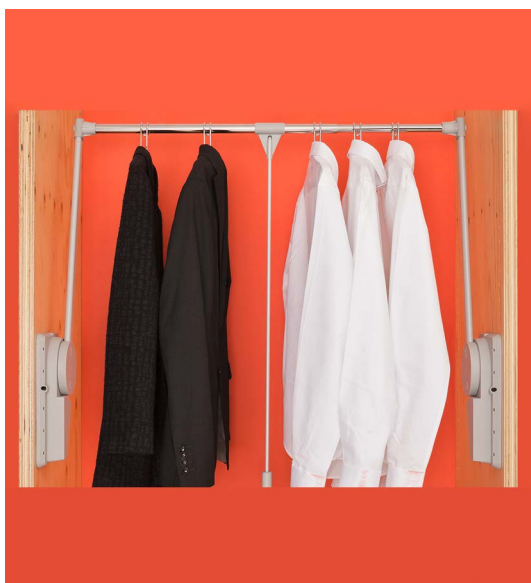
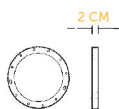

Cabide Super Lift



Regulação da verticalidade do braço.
Regulação da potência.
Possibilidade de aplicar à parede (com suporte vendido à parte).

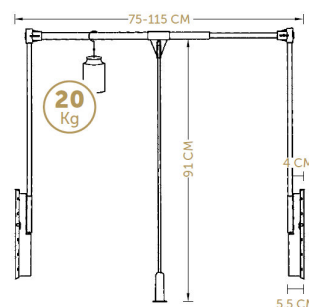

L (mm)



A (mm)



Cap. (kg)

Código

750-1150

910

14-20

151A.SLIFT

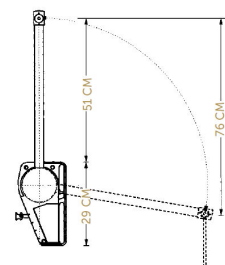

Acessórios para Cabide Super Lift

Artigo	L (mm)	A (mm)	Código
Distanciador	-	-	152A.SLIFT.DI
Suporte de parede	425	290	153A.SLIFT.SP

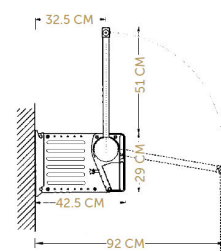



Cabide Lift 700



Forma que evita dobradiças.

L (mm)	A (mm)	Cap. (kg)	Código
750-1150	910	15	700A.LIFT700

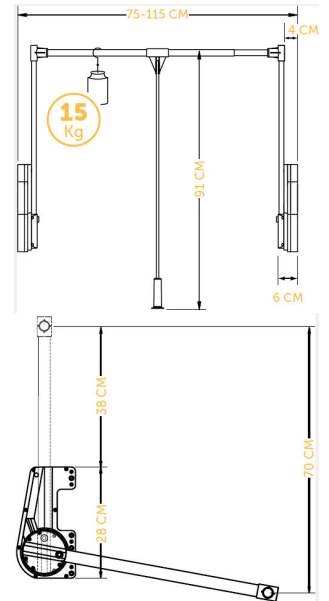

Distanciador

P (mm)	Código
20	701A.LIFT.DI

Trombone Cruzetas



Extensível em 31 cm.
4 ganchos com capacidade para 16 cruzetas.

P (mm)	Código
510	405A.TROMB

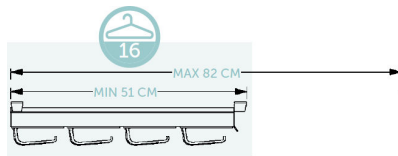

Calceiro Central



Extensível em 31 cm.
Capacidade para 10 calças.

L (mm)	P (mm)	Código
355	510	407A.PCALC

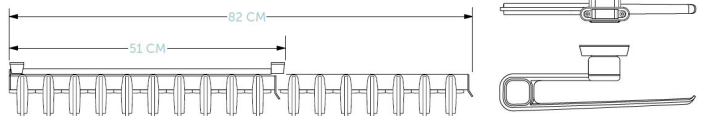

Calceiro Central Duplo



Extensível em 31 cm.
Capacidade para 20 calças.

L (mm)	P (mm)	Código
680	510	409A.PCALCD

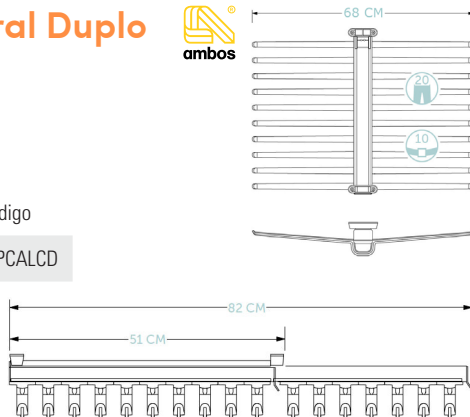

Porta-Calças



Extensível em 31 cm.

Fornecido com 12 cruzetas para até 24 calças.



L (mm)



P (mm)



A (mm)

Código

750-1150

510

110

402A.PCALC

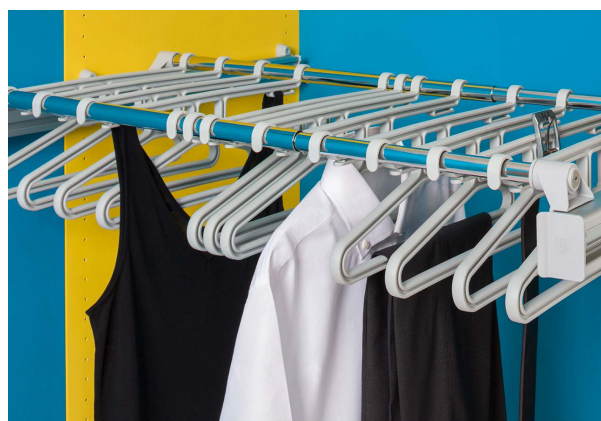
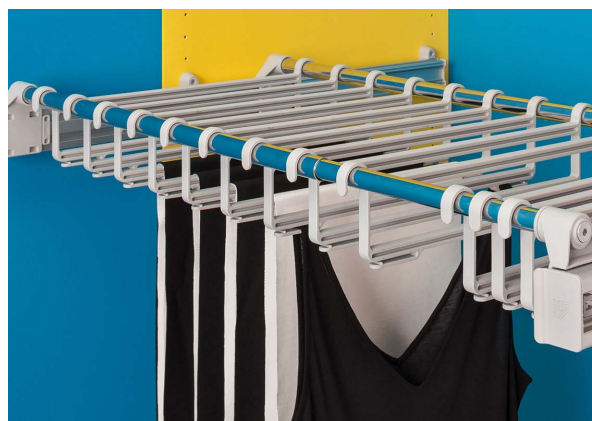
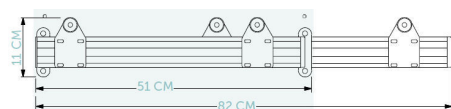
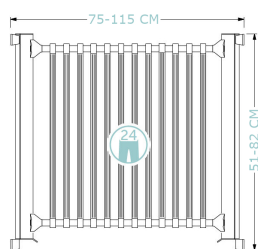

Porta-Cruzetas



Extensível em 31 cm.

Fornecido com 12 cruzetas para até 24 calças.



L (mm)



P (mm)



A (mm)

Código

750-1150

510

110

404A.PCRUZ

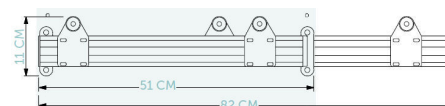
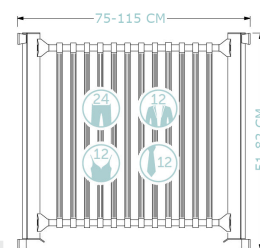

Porta-Gravatas



Extensível em 31 cm.

Capacidade para 19 gravatas.



P (mm)



A (mm)

Código

510

99

142A.PGRAV

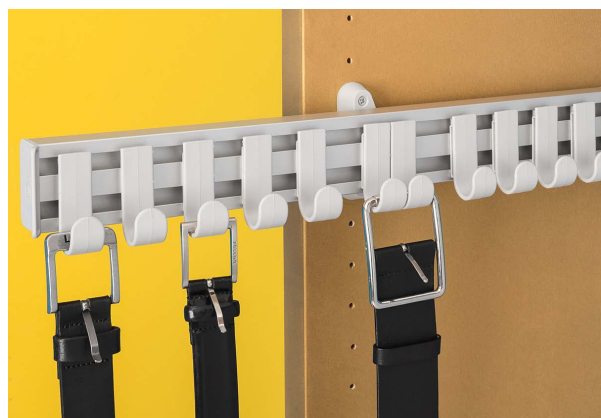
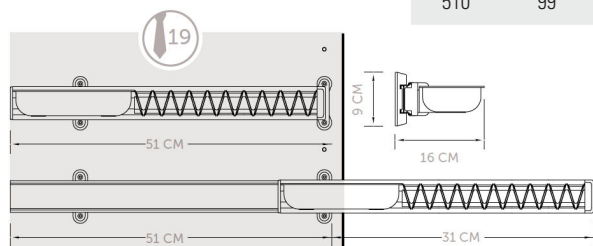

Porta-Cintos



Extensível em 31 cm.

Capacidade para 12 cintos.



P (mm)



A (mm)

Código

510

90

162A.PCINT

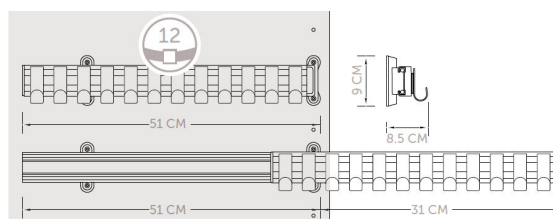

Sapateira Lateral

Fixação lateral.

Possibilidade de aplicação em guias de alumínio (vendido à parte)

L (mm)	P (mm)	A (mm)	Código
480-830	130	90	115A.SAPLP
830-1130	130	90	116A.SAPLG

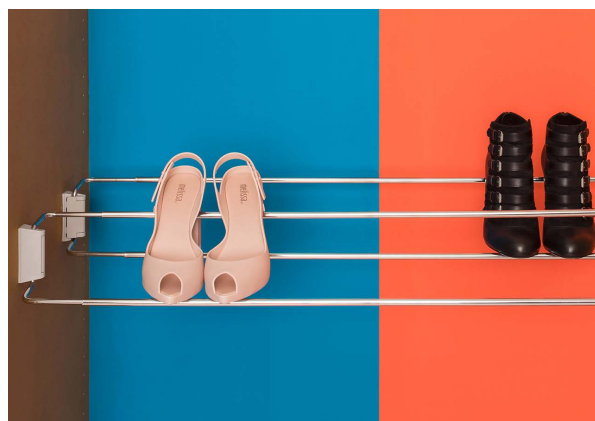
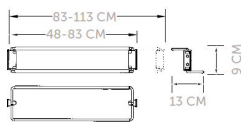

Sapateira Frontal

Fixação frontal.

Possibilidade de aplicação em guias de alumínio (vendido à parte)

L (mm)	P (mm)	A (mm)	Código
480-830	210	90	111A.SAPFP
830-1130	210	90	112A.SAPFG

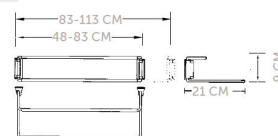

Guias de Alumínio para Sapateiras

Capacidade para 6 sapateiras laterais/ frontais.

L (mm)	P (mm)	A (mm)	Código
15	30	1120	117A.SAPGUIA

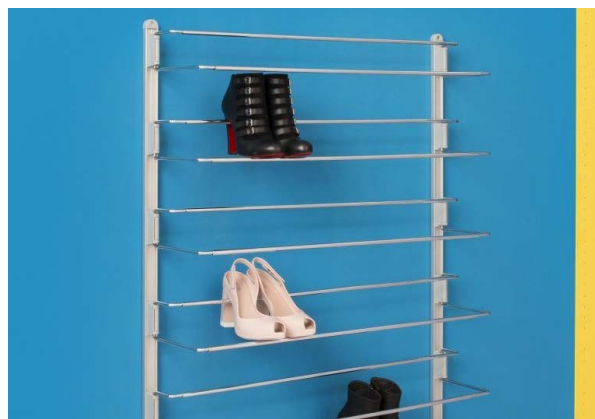
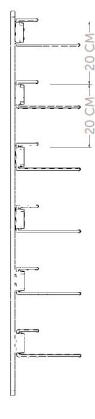
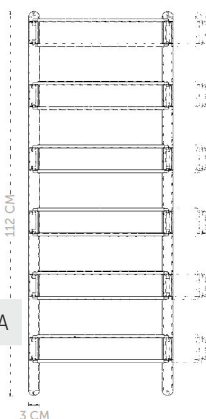

Suporte para Botas

L (mm)	P (mm)	A (mm)	Código
100	130	65	121A.SBOTAS

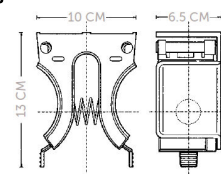



Elevador de Roupeiro

Mód.	Acabamento			
	Alumínio	Antracite	Moka	Preto
60-70	ER.P60.A	ER.P60.ANT	ER.P60.MK	ER.P60.P
70-90	ER.P70.A	ER.P70.ANT	ER.P70.MK	ER.P70.P
90-120	ER.P90.A	ER.P90.ANT	ER.P90.MK	ER.P90.P

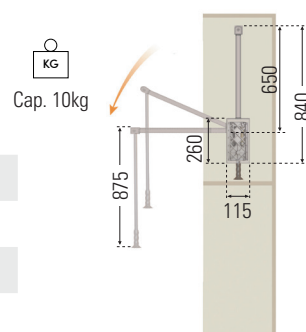

Distanciador de 25mm

		Alumínio	Antracite	Moka	Preto
		ER.P.DA	ER.P.DANT	ER.P.DMK	ER.P.DP

Elevador de Roupeiro Intoo

nexo|05

L (mm)	Acabamento		
	Moca	Alumínio	Branco
450-600	ER.21809	ER.23811	ER.27960
600-830	ER.21810	ER.23813	ER.27961
830-1150	ER.21811	ER.23815	ER.27850

Cap. 10kg



Calceiro Standard

Extraível.
Possibilidade de abertura automática com suporte frontal de gaveta (vendido à parte).

L (mm)	P (mm)	A (mm)	Barras	Acab.	Código
350	380	120	9	Cromado	C.STAND.9
350	480	120	11	Cromado	C.STAND.11



C.LUX.FF

Calceiro Lux

Revestimento anti-deslizante de silicone.
Extraível.
Possibilidade de abertura automática com suporte frontal de gaveta (vendido à parte).

L (mm)	P (mm)	A (mm)	Barras	Acab.	Revestimento	Código
350	380	120	9	Cromado	Silicone	C.LUX.9S
350	480	120	11	Cromado	Silicone	C.LUX.11S



Revestimento em silicone



C.LUX.FF



Calceiro 8AC

Extraível.



L (mm)	P (mm)	A (mm)	Barras	Código
690	475	85	10	C.8AC

Sapateira de Gaveta de Extração Parcial

Extração parcial.

Extensível e extraível.

Possibilidade de abertura automática com suporte frontal de gaveta (vendido à parte).

L (mm)	P (mm)	Altura da guia (mm)	Acab.	Código
400-600	450	27	Cromado	SEGEP.400
600-1000	450	27	Cromado	SEGEP.600

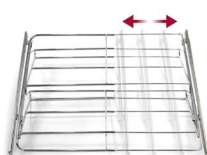

SEG.FF

Sapateira de Gaveta de Extração Total

Extração total.

Extensível e extraível.

Possibilidade de abertura automática com suporte frontal de gaveta (vendido à parte).

L (mm)	P (mm)	Altura da guia (mm)	Acab.	Código
400-600	450	35	Cromado	SEGET.400
600-1000	450	35	Cromado	SEGET.600

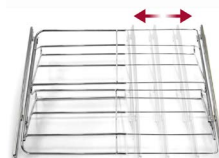

SEG.FF

Sapateira Abatível

Plástico.

Adaptável até o tamanho de sapato 44 (EU).

Frente	Acab.	Código
35	Branco	SA.B

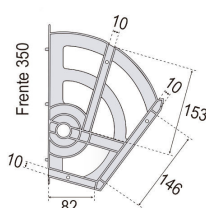
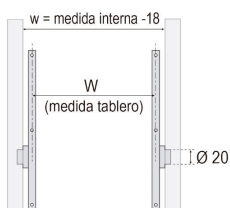

Sapateira Hailo



Gaveta Universal



Fixação na ilharga lateral de 16 mm.
Corrediças sincronizadas.
Gaveta de metal pintado.

Cap. 18 kg

Mód.	L (mm)	P (mm)	A (mm)	Acab.	Código
60	568	510	68	Branco	H.3271351
60	568	510	68	Antracite	H.3271831



Sapateira



Sapateira metálica de aplicação na gaveta universal.

L (mm)	P (mm)	A (mm)	Acab.	Código
496	356	158	Branco	H.3271661



Cabide Trombone

P (mm)	Acabamento	
	Antracite	Moka
300	CT.300.ANT	CT.300.MK
350	CT.350.ANT	CT.350.MK
400	CT.400.ANT	CT.400.MK

100
40 P+7



Cabide Trombone 1G

P (mm)	P estendido (mm)	Código
280	410	CT.1G.280
330	510	CT.1G.330
380	610	CT.1G.380
430	710	CT.1G.430
480	810	CT.1G.480
530	910	CT.1G.530

65

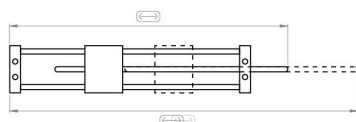

Espelho de Roupeiro 1

Extensível.

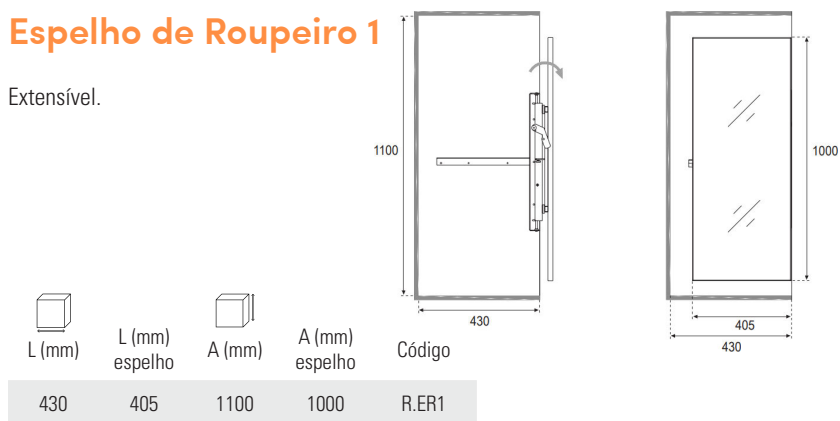

L (mm)	L (mm) espelho	A (mm)	A (mm) espelho	Código
430	405	1100	1000	R.ER1

Espelho de Roupeiro 2



L (mm)	P (mm)	A (mm)	Código
300	40	1000	R.ER2

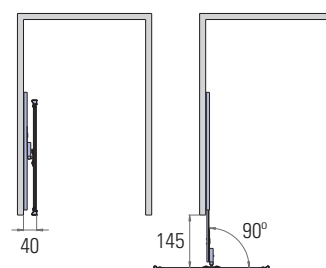

Espelho de Roupeiro Básico Intoo nexo105

Extraível com rotação de 90°.

L (mm)	P (mm)	A (mm)	Acab.	Código
423	56	1040	Branco	ER.21800
423	56	1040	Moca	ER.21801



Espelho de Roupeiro Compacto Intoo nexo105

Extraível com rotação de 90°.

L (mm)	P (mm)	A (mm)	Acab.	Código
340	40	1000	Branco	ER.21849
340	40	1000	Moca	ER.21850

Tábua de Engomar de Fixação Vertical

L (mm)	P (mm)	A (mm)	Código
400	450	1800	TEFV

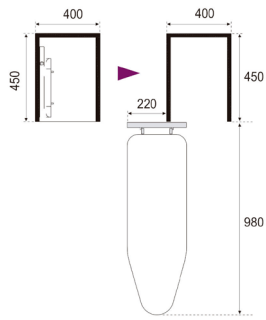

Tábua de Engomar de Fixação Horizontal

L (mm)	P (mm)	Código
400	460	TEFH

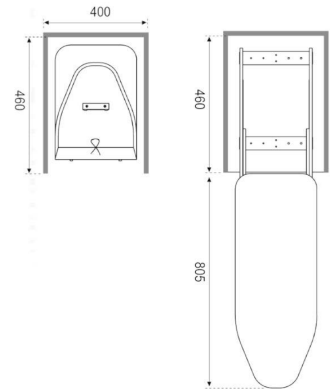

Organizador em Veludo

Perfil



C (mm)	P (mm)	Acab.	Altura (mm)	
2000	8	Cinza	ARV.P60	ARV.P90



Porta-Relógio



L (mm)	P (mm)	A (mm)	Acab.	Código
85	70	45	Cinza	ARV.PR

Conectores

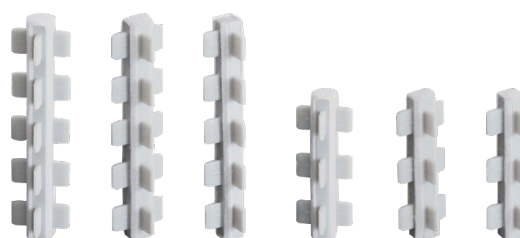

90 mm

60 mm

Porta-Anéis



L (mm)	P (mm)	A (mm)	Acab.	Código
120	100	50	Cinza	ARV.PA



4 vias

3 vias

2 vias

Vias	Acab.	Altura (mm)	
		60	90
2	Cinza	ARV.2V.60	ARV.2V.90
3	Cinza	ARV.3V.60	ARV.3V.90
4	Cinza	ARV.4V.60	ARV.4V.90

Tapete Autoadesivo



L (mm)	P (mm)	Acab.	Código
10000	1500	Cinza	ARV.TV.R10M
1500	1500	Cinza	ARV.TV.1M

Organizador Belnet Wood

Todos os acessórios em madeira de carvalho e antracite.



Porta-Relógios

Medidas	Código
150 x 472 x 50	BA556.004.003



Porta-Óculos

Medidas	Código
150 x 472 x 50	BA556.010.003



Porta-Jóias

Medidas	Código
150 x 472 x 50	BA556.003.003



Porta-Brincos

Medidas	Código
150 x 472 x 50	BA556.008.003

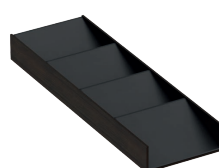

Porta-Complementos

Medidas	Código
150 x 472 x 50	BA556.009.003



Porta-Cintos

Medidas	Código
150 x 472 x 50	BA556.002.003



Porta-Gravatas

Medidas	Código
150 x 472 x 50	BA556.007.002



Tabuleiro Universal

Medidas	Código
150 x 472 x 50	BA556.001.003



Porta-Maquiagem

Medidas	Código
150 x 472 x 50	BA556.011.003



Tapete de 12 metros

Medidas	Código
12 000 x 472	BA560.001.001



Caixa Com Tampa

Medidas	Código
350 x 330 x 205	BA558.001.002
350 x 430 x 205	BA558.001.003



Caixa Sem Tampa

Medidas	Código
275 x 332 x 85	BA558.003.005

Organizador Belnet Millennial

Todos os acessórios em tecido e veludo.



Porta-Relógios

Medidas	Código
181 x 181 x 30	BA559.003.002

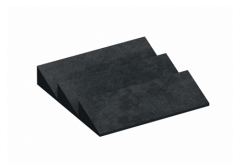

Porta-Óculos

Medidas	Código
181 x 181 x 30	BA559.004.002



Porta-Jóias

Medidas	Código
181 x 181 x 30	BA559.002.002



Tabuleiro Universal

Medidas	Código
194 x 432 x 49	BA559.001.002



Divisória Tabuleiro

Medidas	Código
181 x 181 x 30	BA559.005.002