

CEMUX

HAUSSMANN

scilm



RODAPÉS E PÉS PARA RODAPÉ
CASATREND

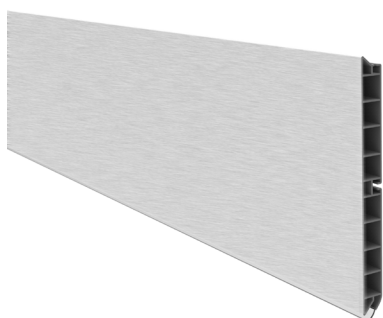

Rodapé de PVC Cemux

Barra de 4 metros.

A (mm)	Acab.	Código
100	Alumínio escovado	KP01100AL
120	Alumínio escovado	KP01120AL
150	Alumínio escovado	KP01150AL

CEMUX

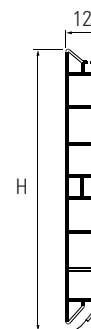

Canto 90º de PVC Cemux

A (mm)	Acab.	Código
100	Alumínio escovado	KP01100AL
120	Alumínio escovado	KP01120AL
150	Alumínio escovado	KP01150AL

CEMUX

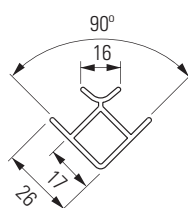

Canto Flexível de PVC Cemux

A (mm)	Acab.	Código
100	Alumínio escovado	KAC02100AL
120	Alumínio escovado	KAC02120AL
150	Alumínio escovado	KAC02150AL

CEMUX

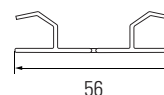

União de PVC Cemux

A (mm)	Acab.	Código
100	Alumínio escovado	KAC03100AL
120	Alumínio escovado	KAC03120AL
150	Alumínio escovado	KAC03150AL

CEMUX

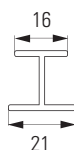

Rodapés

Rodapé de PVC

scilm

Barra de 4 metros.

A (mm)	Caixa (m)	Acabamento					
		Alumínio	Inox	Branco mate	Branco brilho	Preto mate	Antracite mate
100	44	RS100AE	RS100I	RS100BM	RS100BB	RS100PM	RS100ANT
120	40	RS120AE	RS120I	RS120BM	RS120BB	RS120PM	RS120ANT
150	36	RS150AE	RS150I	RS150BM	RS150BB	RS150PM	RS150ANT
170	32	RS170AE	RS170I	RS170BM	RS170BB	-	RS170ANT

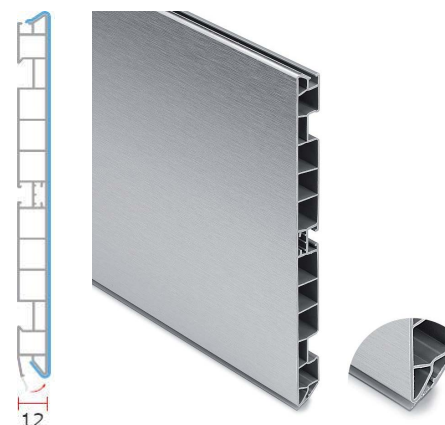

Canto 90° de PVC

scilm

A (mm)	Acabamento		Branco mate	Branco brilho	Antracite mate
	Alumínio	Inox			
100	RSCR100AE	RSCR100I	RSCR100BM	RSCR100BB	RSCR100ANT
120	RSCR120AE	RSCR120I	RSCR120BM	RSCR120BB	RSCR120ANT
150	RSCR150AE	RSCR150I	RSCR150BM	RSCR150BB	RSCR150ANT
170	RSCR170AE	RSCR170I	RSCR170BM	RSCR170BB	RSCR170ANT

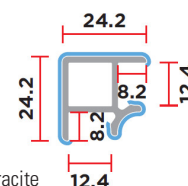

Canto Flexível de PVC

scilm

A (mm)	Acabamento				
	Alumínio	Inox	Branco mate	Branco brilho	Antracite mate
100	RSCF100AE	RSCF100I	RSCF100BM	RSCF100BB	RSCF100ANT
120	RSCF120AE	RSCF120I	RSCF120BM	RSCF120BB	RSCF120ANT
150	RSCF150AE	RSCF150I	RSCF150BM	RSCF150BB	RSCF150ANT
170	RSCF170AE	RSCF170I	RSCF170BM	RSCF170BB	RSCF170ANT

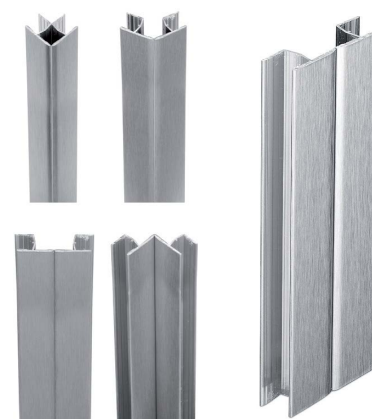
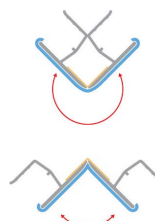
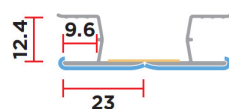

Rodapé de Alumínio Sistema A

Barra de 3,95 metros.
Caixa de 10 barras.

A (mm)	Acabamento			
	Mate	Branco mate	Branco brilho	Preto mate
102	RA102A	RA102BM	RA102BR	RA102PM
146	RA146A	RA146BM	RA146BR	RA146PM
166	RA166A	RA166BM	RA166BR	RA166PM

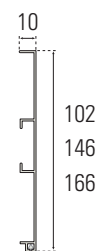

Canto Flexível para Rodapé de Alumínio Sistema A

A (mm)	Acabamento				
	Mate	Branco mate	Branco brilho	Preto mate	Preto brilho
102	RACF102A	RACF102BM	RACF102BR	RACF102PM	RACF102PB
146	RACF146A	RACF146BM	RACF146BR	RACF146PM	RACF146PB
166	RACF166A	RACF166BM	RACF166BR	RACF166PM	RACF166PB

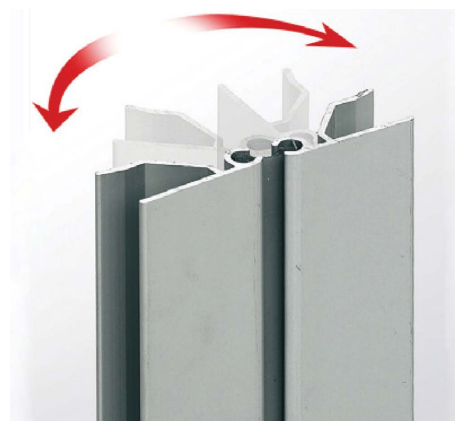
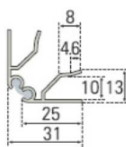

Rodapé de Alumínio Sistema B

Barra de 3,6 e de 4 metros.
Caixa de 16 barras.

C (m)	A (mm)	Acab.	Código
3,6	80	Mate	RB80A
4,0	95	Mate	RB95A
4,0	120	Mate	RB120A
4,0	145	Mate	RB145A



Canto 90° para Rodapé de Alumínio Sistema B

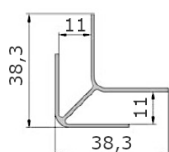

A (mm)	Acab.	Código
80	Mate	RBCR80A
95	Mate	RBCR95A
120	Mate	RBCR120A
145	Mate	RBCR145A



Canto Flexível para Rodapé de Alumínio Sistema B

A (mm)	Acab.	Código
80	Mate	RBCF80A
95	Mate	RBCF95A
120	Mate	RBCF120A
145	Mate	RBCF145A

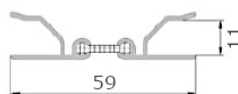

Rodapés

Rodapé de Alumínio Sistema C

Barra de 4 metros.
Caixa de 16 barras.

A (mm)	Acabamento			
	Mate	Brilho	Inox	Branco
100	RC100A	RC100AB	RC100I	RC100B
120	RC120A	RC120AB	RC120I	RC120B
142	RC142A	RC142AB	RC142I	RC142B
170	RC170A	RC170AB	RC170I	RC170B



Canto 90º para Rodapé de Alumínio Sistema C



A (mm)	Acabamento			
	Mate	Brilho	Inox	Branco
100	RCCR100A	RCCR100AB	RCCR100I	RCCR100B
120	RCCR120A	RCCR120AB	RCCR120I	RCCR120B
142	RCCR142A	RCCR142AB	RCCR142I	RCCR142B
170	RCCR170A	RCCR170AB	RCCR170I	RCCR170B

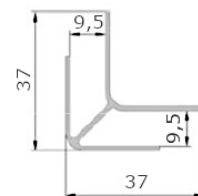

Canto Flexível para Rodapé de Alumínio Sistema C

A (mm)	Acabamento			
	Mate	Brilho	Inox	Branco
100	RCCF100A	RCCF100AB	RCCF100I	RCCF100B
120	RCCF120A	RCCF120AB	RCCF120I	RCCF120B
142	RCCF142A	RCCF142AB	RCCF142I	RCCF142B
170	RCCF170A	RCCF170AB	RCCF170I	RCCF170B

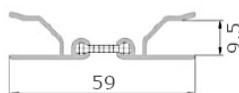

Pé Bucha Ø 13mm

Caixa de 200 unidades.

A (mm)	Acab.	Código
102 – 132	Preto	PE98B13
102 – 145	Preto	PE99B13
132 – 200	Preto	PE97B13

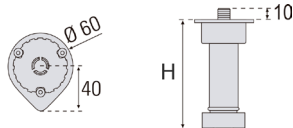

Pé Parafuso

Caixa de 200 unidades.
Fornecido sem parafuso.

A (mm)	Acab.	Código
74 – 90	Preto	PE95PTST
94 – 110	Preto	PE96PTST
102 – 132	Preto	PE98PTST
102 – 145	Preto	PE99PTST
132 – 200	Preto	PE97PTST

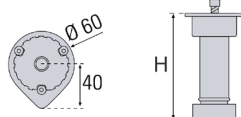

Pé Parafuso

Caixa de 200 unidades.

A (mm)	Acab.	Código
80 *	Preto	PE92PTST
102 – 132	Preto	PE93PTST
132 – 200	Preto	PE94PTST

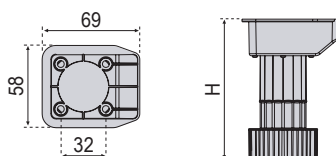

* Altura ajustável na base para aumentar em 10 mm ou diminuir em 5 mm.

Pinça para Rodapé de PVC com Deslize

Modelo	Aplicação	Acab.	Código
98ABC	Rodapé PVC	Preto	PIN98ABC

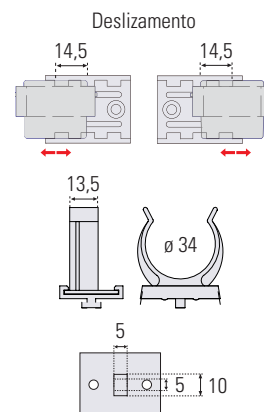

Pés para Rodapé

Pinça para Rodapé de Alumínio



Modelo	Aplicação	Acab.	Código
97ABAF	Rodapé de Alumínio	Preto	PIN97ABAF

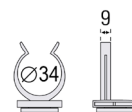

Pinça para Rodapé de PVC

Modelo	Aplicação	Acab.	Código
97ABP	Rodapé PVC	Preto	PIN97ABP

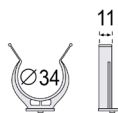

Pé Bone

Caixa de 100 unidades.

Modelo	A (mm)	Acab.	Código
Bone 60	59 – 75	Preto	PE.BONE.60
Bone 80	79 – 95	Preto	PE.BONE.80

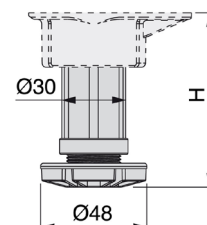

Pé Bone Alto

Caixa de 100 unidades.

Modelo	A (mm)	Acab.	Código
Bone 100	98 – 140	Preto	PE.BONE.100
Bone 120	118 – 160	Preto	PE.BONE.120
Bone 150	148 – 190	Preto	PE.BONE.150

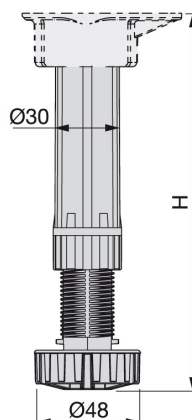

Base para Pé Bone de Parafuso

Caixa de 100 unidades.



Acab.	Código
Preto	PE.BONE.BP

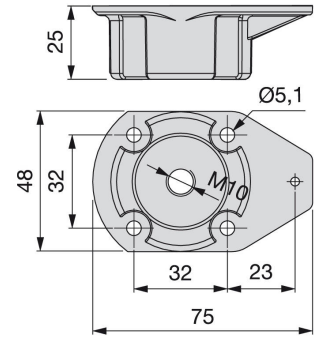

Base para Pé Bone de Bucha Ø 13mm

Caixa de 100 unidades.



Acab.	Código
Preto	PE.BONE.BB13

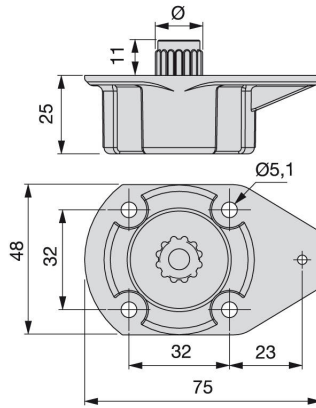

Pinça para Rodapé de Pé Bone

Caixa de 200 unidades.



Acab.	Código
Preto	PE.BONE.P

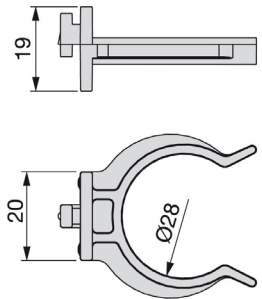

Pé Pax

Altura ajustável.



A (mm)	Amplitude de altura	Acab.	Código
60	53 - 70	Preto	PE.PAX.60
80	70 - 100	Preto	PE.PAX.80
100	90 - 120	Preto	PE.PAX.100
125	115 - 145	Preto	PE.PAX.125
150	140 - 170	Preto	PE.PAX.150
180	170 - 200	Preto	PE.PAX.180
200	190 - 220	Preto	PE.PAX.200

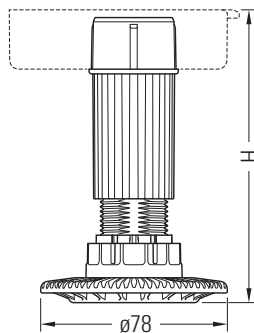

Pés para Rodapé



Base para Pé Pax

Fixação com parafuso.



Acab. Código

Preto PE.PAX.B

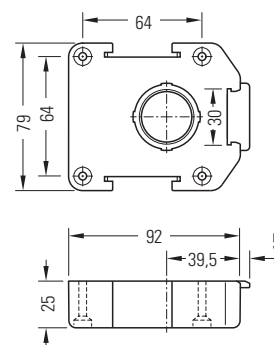

Ferramenta de Ajuste para Pé Pax

Permite ajustar a altura do pé rodando o manípulo à mão ou com uma ferramenta elétrica. Possibilidade de estender o alcance da ferramenta com chave de extensão

Artigo	Código
Ferramenta	PE.PAX.F
Extensão	PE.PAX.E

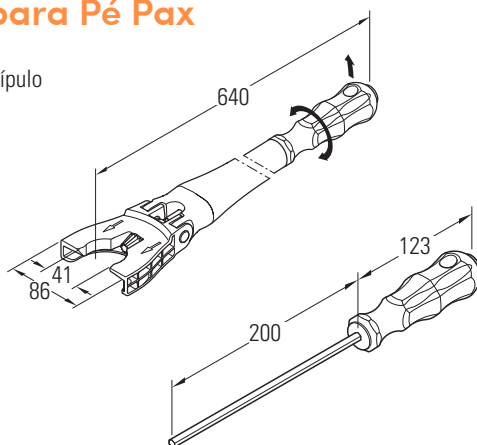

Ferramenta de Ajuste Light para Pé Pax

Permite ajustar a altura do pé rodando o manípulo à mão.

Artigo	Código
Ferramenta	PE.PAX.FL

