



furnital

Gollinucci



# ACESSÓRIOS DECORATIVOS DE COZINHA

CASATREND

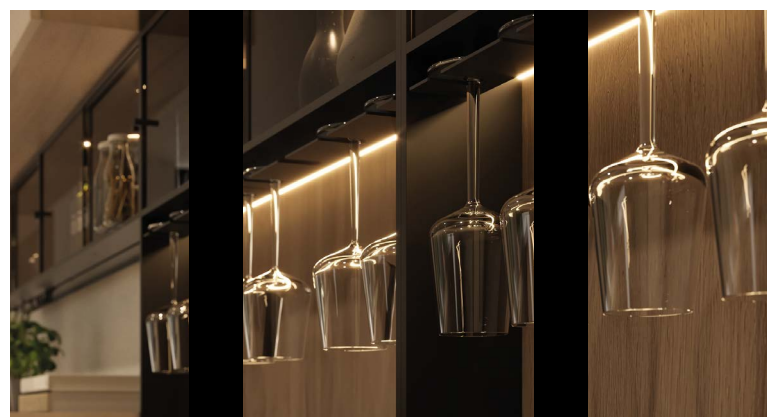



## Addendum

Sistema modular de unidades de parede abertas, vitrinas e prateleiras para qualquer divisão da habitação. Modelos Lux incluem luz 3000/4000K e transformador. Profundidade de 14,2 cm.

Corte sectional lateral

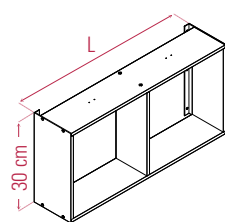
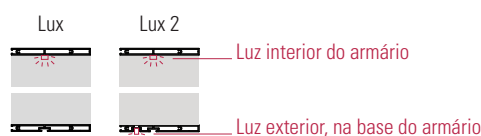

### Módulo aberto

L (cm)	Sem luz	Lux	Lux 2
60	KE1M28007	KE1M28010	KE1M28104
65	KE1M28049	KE1M28050	KE1M28105
75	KE1M28008	KE1M28011	KE1M28106
90	KE1M28009	KE1M28012	KE1M28107

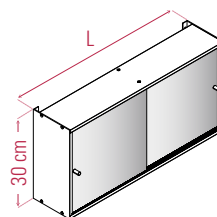

### Módulo com vitrina

L (cm)	Sem luz	Lux	Lux 2
60	KE1M28001	KE1M28004	KE1M28092
65	KE1M28043	KE1M28044	KE1M28093
75	KE1M28002	KE1M28005	KE1M28094
90	KE1M28003	KE1M28006	KE1M28095

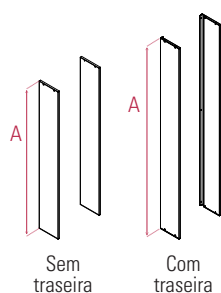

### Par de ilhargas

Para módulos apoiados:

A (cm)	Sem traseira	Com traseira
60-96	KE1M28078	KE1M28013
97-126	KE1M28079	KE1M28014
127-156	KE1M28080	KE1M28015
157-210	KE1M28081	KE1M28076

Para módulos suspensos:

60-96	KE1M28082	KE1M28016
97-126	KE1M28083	KE1M28017
127-156	KE1M28084	KE1M28018
157-210	KE1M28085	KE1M28077

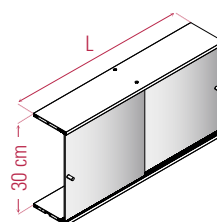

### Kit vitrina

Inclui prateleiras superior e inferior, e portas vitrina deslizantes de vidro fumado.

L (cm)	Sem luz	Lux	Lux 2
58	KE1M28019	KE1M28022	KE1M28096
63	KE1M28045	KE1M28046	KE1M28097
73	KE1M28020	KE1M28023	KE1M28098
88	KE1M28021	KE1M28024	KE1M28099

## Acessórios



### Extensão e gancho

L (cm)	Código
28	KE1M28086
38	KE1M28087
58	KE1M28088
63	KE1M28089
73	KE1M28090
88	KE1M28091

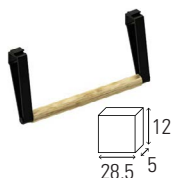

### Porta-rolos

Suporte de alumínio com barra de madeira.

DB1A11015



### 3 Ganchos

Em alumínio.

DB1A04012



### Barra transversal

L (cm)	Código
45-60	KE1M19041
60-90	KE1M19054
90-120	KE1M19050

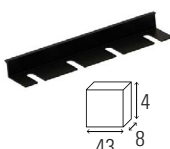

### Porta-copos

Em alumínio.

DB1A08008

### Sistema LED

Completo com cabo e fita 3000/4000K d-motion.

ED1A01017

### Prateleira metálica

Ranhura opcional para acessórios.

L (cm)	Sem ranhura	Com ranhura	Com luz e ranhura
28	KE1M28055	—	—
38	KE1M28056	—	—
58	KE1M28028	KE1M28025	KE1M28100
63	KE1M28052	KE1M28051	KE1M28101
73	KE1M28029	KE1M28026	KE1M28102
88	KE1M28030	KE1M28027	KE1M28103

### Transformador LED

D-POWER com 6 inputs. 24Vdc.

30W	60W	100W
EC1A00004	EC1A00005	EC1A00006
150W	200W	
EC1A00008	EC1A00009	

### Acabamentos

Módulo e acessórios:

	Titânio (TI)		Cobre (CB)
	Latão (LT)		Preto (PR)





## Side

Estrutura de alumínio customizável com vários acessórios. Pode ser integrado com qualquer painel de fundo.

O número e posição das prateleiras pode ser variável. Profundidade de 14,2 cm.

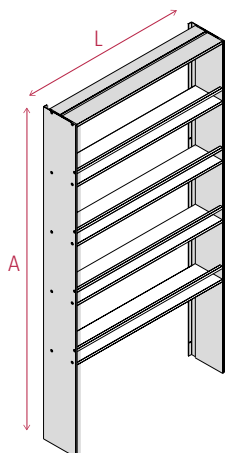

### Módulo apoiado

Não inclui as prateleiras.

L (cm)	60-96	97-126	127-156
45	KE1M19013	KE1M19015	KE1M19011
60	KE1M19020	KE1M19022	KE1M19018
65	KE1M19027	KE1M19029	KE1M19025
75	KE1M19034	KE1M19036	KE1M19032
90	KE1M19086	KE1M19088	KE1M19084
120	KE1M19092	KE1M19094	KE1M19090

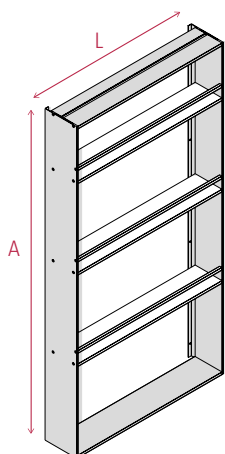

### Módulo suspenso

Não inclui as prateleiras.

L (cm)	60-96	97-126	127-156
45	KE1M19014	KE1M19016	KE1M19012
60	KE1M19021	KE1M19023	KE1M19019
65	KE1M19028	KE1M19030	KE1M19057
75	KE1M19035	KE1M19037	KE1M19033
90	KE1M19087	KE1M19089	KE1M19085
120	KE1M19093	KE1M19095	KE1M19091

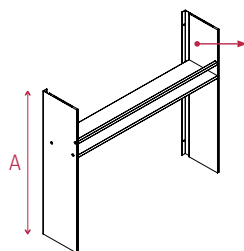

### Par de laterais

Não inclui as prateleiras.

A (cm)	Código
51-59	KE1M19001

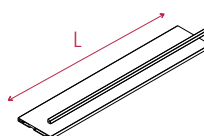

### Prateleira e varão

L (cm)	Código
45	KE1M19010
60	KE1M19017
65	KE1M19024
75	KE1M19031
90	KE1M19038
120	KE1M19009

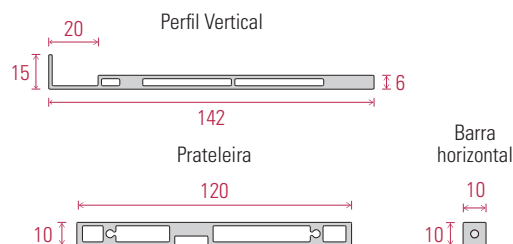

## Acessórios

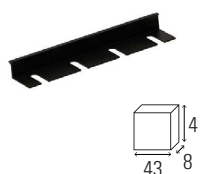

### Porta-copos

Em alumínio.

DB1A08008

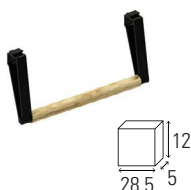

### Porta-rolos

Suporte de alumínio com barra de madeira.

DB1A11015

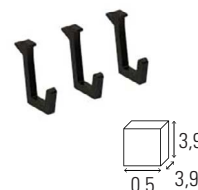

### 3 Ganchos

Em alumínio.

DB1A04012

## Acabamentos

Módulo e acessórios:

-  Bronze (BZ)
-  Preto (PR)
-  Titânio (TI)

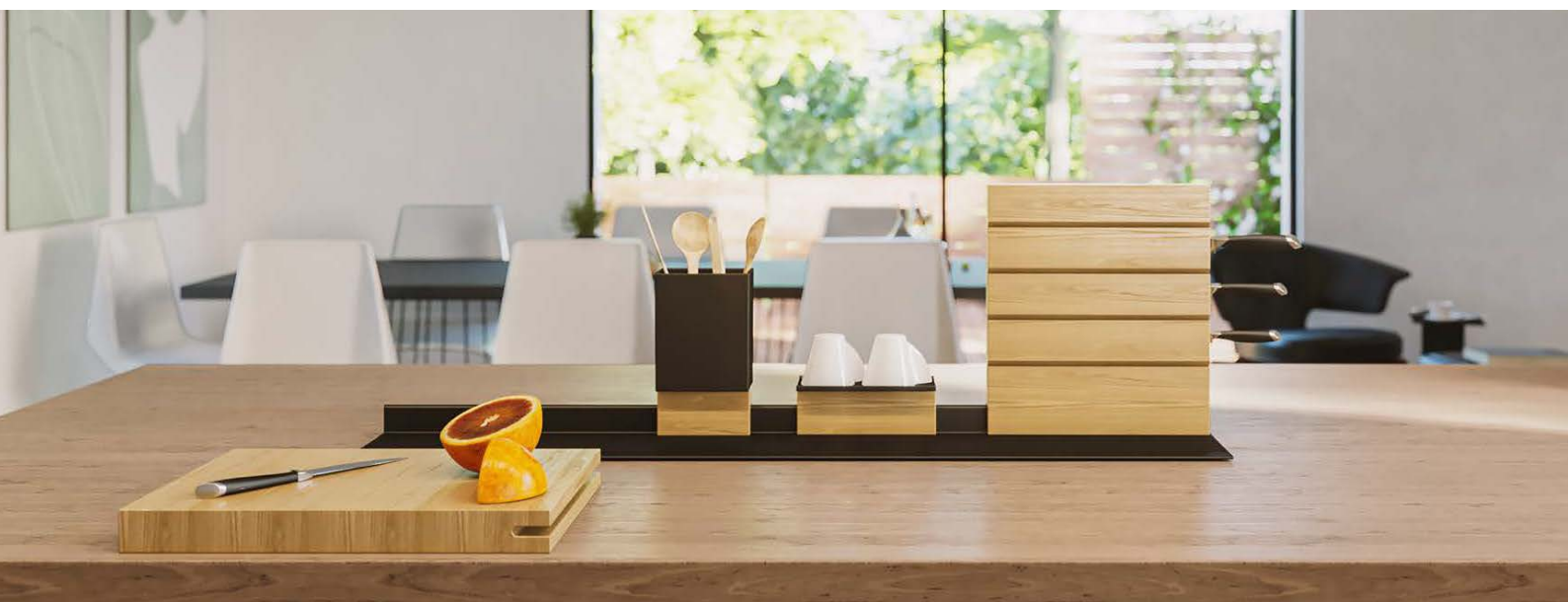



## Tray

Composto por uma base em alumínio com uma barra. Os acessórios são colocados sobre suportes de madeira que deslizam por essa barra. Não estando ancorada a nenhuma parede, o sistema pode ser deslocado para qualquer lugar.

### Sugestões de composição

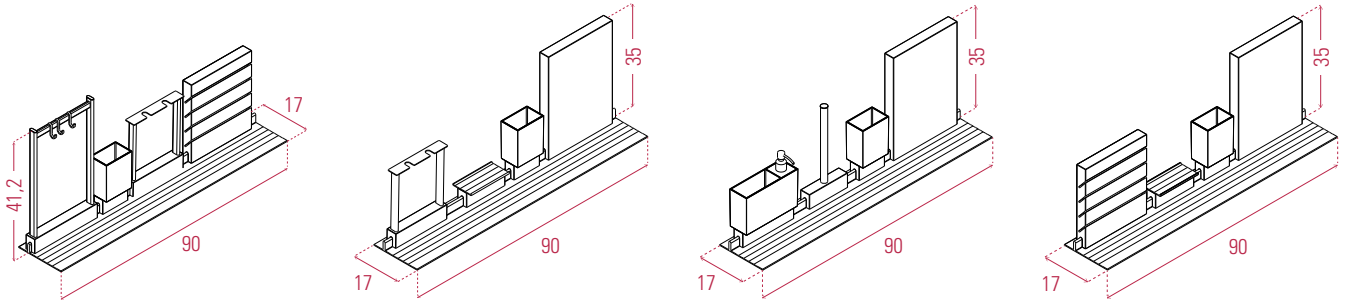

### Estrutura

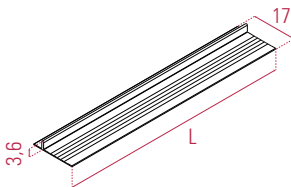

#### Base



L (cm)	Código
60	KE1M22007
90	KE1M22001

### Acabamentos

Módulo e acessórios:

Preto (PR)

Madeira:

Faia

### Acessórios

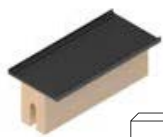

#### Prateleira

DB1A05066



#### Porta-copos

DB1A08009



#### Porta-colheres

Inclui 3 ganchos.

DB1A10007

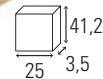

#### Porta-rolos

DB1A11022



#### Porta-facas

DB1A09006



#### Tábua de corte

DB1A20009

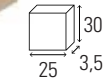

#### Recipiente

De plástico com base em madeira.

DB1A10008



#### Doseador de detergente

De plástico com base em madeira.

DB1A19003



#### 3 ganchos

DB1A04029

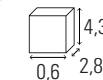





## Hang

Sistema suspenso e leve para prateleiras de cozinha. Sendo montado na base de armários superiores, não apresenta qualquer risco de danificar a parede da cozinha. Existe versão com iluminação.

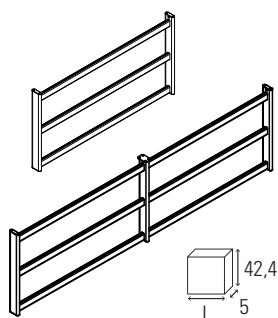

### Módulo Hang

Modelo duplo tem o dobro da largura "L (cm)".

L (cm)	Modelo	
	Single	Duplo
60	KE1M02001	KE1M02005
75	KE1M02002	—
90	KE1M02003	KE1M02006
120	KE1M02004	—

## Hang Top

Sistema de prateleiras desenhado para ilhas ou penínsulas de cozinha. Versão montada no balcão. Existe versão com iluminação.

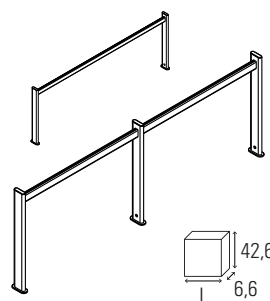

### Módulo Hang Top

Modelo duplo tem o dobro da largura "L (cm)".

L (cm)	Modelo	
	Single	Duplo
60	KE1M04001	KE1M04005
75	KE1M04002	KE1M04032
90	KE1M04003	KE1M04006
120	KE1M04004	—

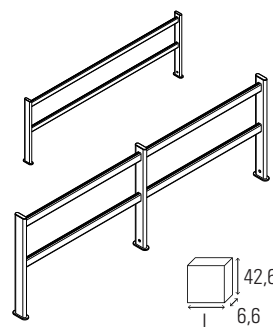

### Módulo Hang Top 2

Modelo duplo tem o dobro da largura "L (cm)".

L (cm)	Modelo	
	Single	Duplo
60	KE1M04007	KE1M04011
75	KE1M04008	KE1M04033
90	KE1M04009	KE1M04012
120	KE1M04010	—

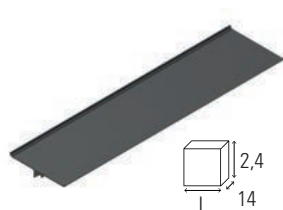

### Prateleira Metálica

L (cm)	Código
55	DB1A05025
70	DB1A05070
85	DB1A05024
115	DB1A05026

## Acessórios



### Porta-rolos

DB1A11010

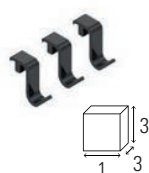

### 3 ganchos superiores

DB1A04009

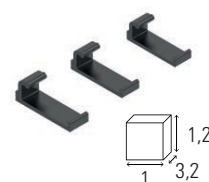

### 3 ganchos inferiores

DB1A04010

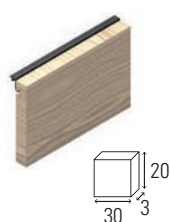

### Tábua de corte

DB1A20004



### Porta-facas

DB1A09004

## Acabamentos

Módulo e acessórios:

Bronze (BZ)

Preto (PR)

Titânio (TI)

Madeira:

Faia

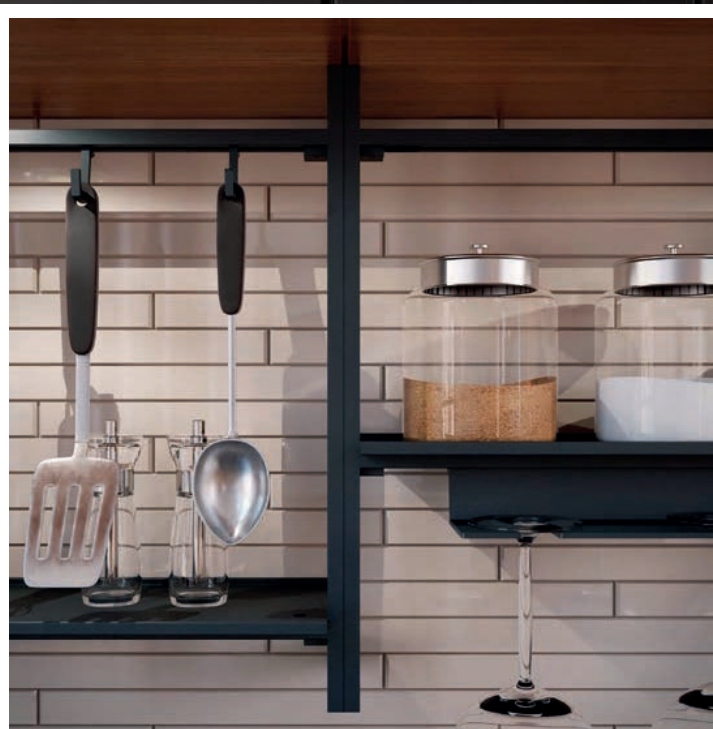



## Up

Desenhado para manter o balcão livre. Montado na base inferior dos armários.

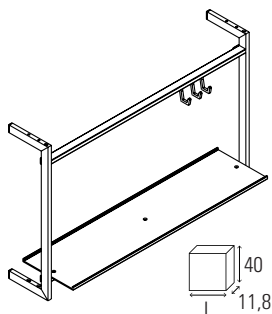

### Kit

Inclui prateleira e kit de 3 ganchos.



L (cm)

Código

60

KE1M05001

90

KE1M05002



## Acessórios



### Porta-copos

Em alumínio.

DB1A08008



### Porta-rolos

Suporte de alumínio com barra de madeira.

DB1A11015



### 3 Ganchos

Em alumínio.

DB1A04012



## Acabamentos

Módulo e acessórios:

 Cinza escuro (CE)

 Preto (PR)

 Titânio (TI)





## Dama-L

Estrutura de alumínio modular e multifuncional, com um desenho minimalista e refinado. A ampla gama de acessórios permite adaptar o Dama-L a qualquer divisão da casa. Profundidade de 15,5 cm.

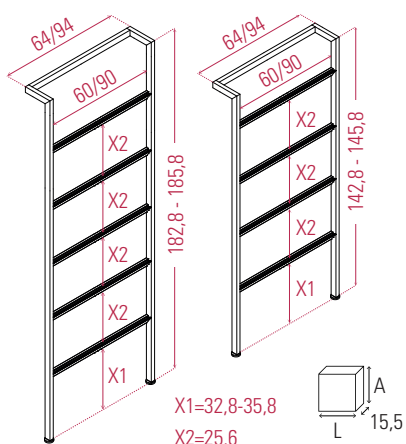

### Módulo

Inclui a composição do desenho.

L (cm)	A (cm)	Código
60	140	LE1P13001
90	140	LE1P13002
60	180	LE1P13003
90	180	LE1P13004

### Acabamentos

Módulo e acessórios (excepto os mencionados abaixo):

Ferro (FE) Preto (PR)

Acessórios Pratika:

Âmbar (AM) Pomba (PO)  
 Branco (B) Preto (PR)  
 Cinza tráfego (CT) Verde sálvia (VS)  
 Concha (CO) Vulcão (VU)  
 Ferro (FE)

Saco:

Castanho (CA) Cinza (CI)

### Acessórios

#### Prateleira metálica

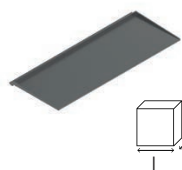

L (cm)	Código
27	DB1A05038
45	DB1A05037
60	DB1A05036

#### Suporte Prateleira

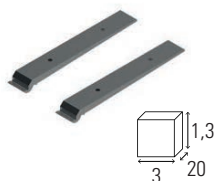

EA1A00006

#### Adaptador Pratika

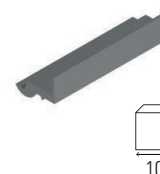

Necessário para os acessórios Pratika.

DB1A01001

#### 3 ganchos

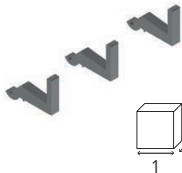

DB1A04013

#### 3 ganchos para painéis

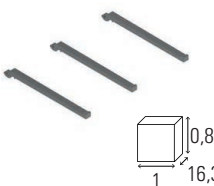

DB1A15001

#### Porta-rolos



DB1A11012

#### Porta-garrafas / porta-cálices

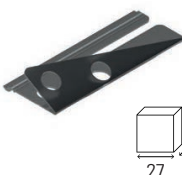

DB1A16001

#### Recipiente de cutelaria Pratika

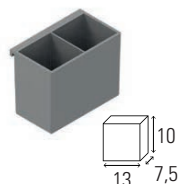

DB1A10004

#### Recipiente de frascos Pratika

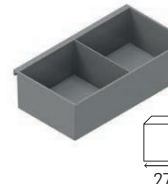

DB1A07008

#### Recipiente de especiarias Pratika

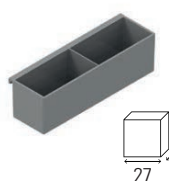

DB1A12007

#### Saco

L (cm)	P (cm)	A (cm)	Código
9	8,5	18	DB1A03002
14	9,5	16	DB1A03003
40	20	30	DB1A03004





## Horizon

Esta pequena prateleira é útil para colocar todas as ferramentas essenciais de cozinha: facas, utensílios, especiarias, livros.. E o seu design é perfeito para ambos espaços clássicos e modernos.

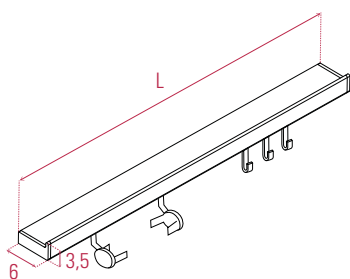

### Módulo Horkit

L (cm)	Código
60	KE1M07005
90	KE1M07004
120	KE1M07006

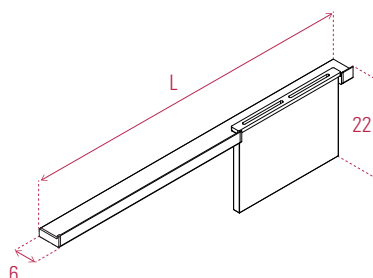

### Módulo Horizon T

L (cm)	Código
90	KE1M17002
120	KE1M17001

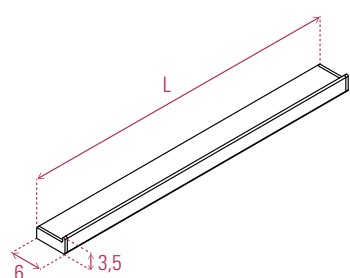

### Módulo Horizon

L (cm)	Código
60	KE1M07005P
90	KE1M07004P
120	KE1M07006P

## Acessórios



### Porta-rolos

DB1A11009

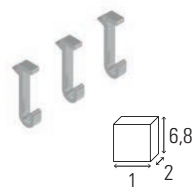

### 3 ganchos

DB1A04007

## Acabamentos

Módulo e acessórios:

	Anodizado escovado (AE)		Ouro antigo (OA)
	Bronze (BZ)		Preto (PR)
	Cinza escuro (CE)		Titânio (TI)
	Ferro (FE)		





## Firkant

Este modelo tem um perfil raso e um sistema de ganchos e acessórios fácil e intuitivo. O seu design minimalista adequa-se a qualquer tipo de cozinha.

### Módulo

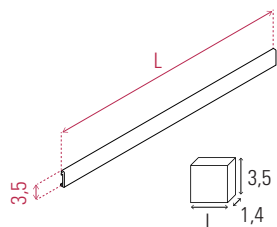

L (cm)	Ganchos incluídos	Código
60	2	KE1M09002
90	3	KE1M09003
120	4	KE1M09001

### Acessórios

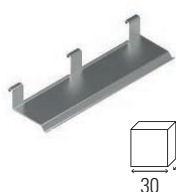

#### Prateleira

DB1A05039

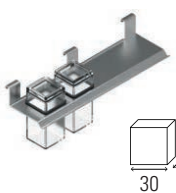

#### Prateleira e 2 porta-especiarias

DB1A12002

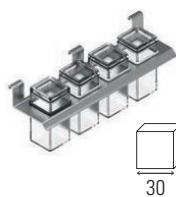

#### 4 porta-especiarias

DB1A12003



#### Gancho

DB1A04015

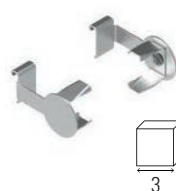

#### Porta-rolos

DB1A11013



### Acabamentos

Módulo e acessórios:

	Anodizado escovado (AE)		Cinza escuro (CE)
	Anodizado polido (AP)		Titânio (TI)
	Ferro (FE)		





## Pratika

Modelo fácil e simples, com acessórios que podem ser removidos da barra e colocados na mesa.

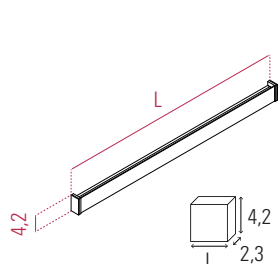

### Módulo

L (cm)	Ganchos incluídos	Código
60	2	KE1M12001
90	3	KE1M12002

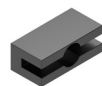

### União de módulos

EB1A00009

## Acessórios

### Porta-rolos



DB1A11023



### Recipiente de especiarias

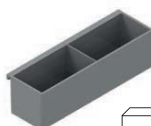

DB1A12007



### Recipiente de cutelaria



DB1A10004



### Recipiente de frascos

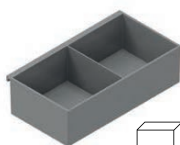

DB1A07008



### 3 ganchos



DB1A04023



## Acabamentos

Módulo e ganchos:

Anodizado escovado (AE)	Preto (PR)
Anodizado polido (AP)	Titânio (TI)
Cinza escuro (CE)	

Porta-rolos e recipientes:

Âmbar (AM)	Ferro (FE)	Vulcão (VU)
Branco (B)	Pomba (PO)	
Cinza tráfego (CT)	Preto (PR)	
Concha (CO)	Verde sálvia (VS)	





## Rise

Modelo desenhado para a casa-de-banho. As suas linhas simples e desenho minimalista tornam-no adequado para qualquer estilo de casa-de-banho.

### Módulo

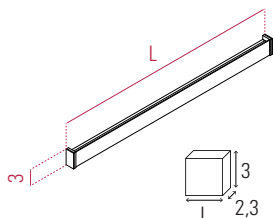

L (cm)	Código
90	KE1M15001
120	KE1M15002

### Acessórios

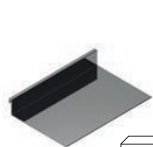

#### Prateleira

DB1A05012

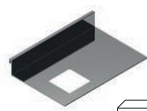

#### Prateleira com 1 furo

DB1A05011

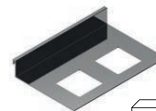

#### Prateleira com 2 furos

DB1A05010

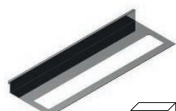

#### Suporte para toalhas

DB1A18001

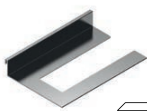

#### Porta-rolos

DB1A11001

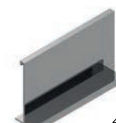

#### Suporte para tablet

DB1A13001



#### Suporte para telemóvel

DB1A23001



#### Copo

DB1A25001



#### Doseador de detergente

DB1A24001



### Acabamentos

Módulo e acessórios:



Ral 7016



Ral 9003

## Belnet para Encastre

Acessório elegante e prático para manter o balcão de cozinha organizado.

Módulo	L (mm)	P (mm)	A (mm)	Acab.	Código
90	860	200	60	Preto	BN526.001.024
120	982	200	60	Preto	BN526.001.025
150	1333	200	60	Preto	BN526.001.026
180	1690	200	60	Preto	BN526.001.027

### Mapa de Acessórios:

Mód. 90	AL + B	Tampa		
Mód. 120	AL + B	AL + B		
Mód. 150	AL + B	Tampa	AL + B	
Mód. 180	AL + B	Tampa	AL + B	Tampa

Não são colocados acessórios nos compartimentos com a tampa.

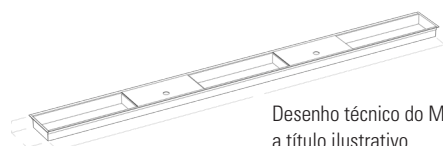

Desenho técnico do Mód. 220, a título ilustrativo



## Belnet Exterior de 1 ou 2 Níveis

Acessório elegante e prático para manter o balcão de cozinha organizado. Fixo ao balcão, mas amovível.

Módulo	L (mm)	P (mm)	A (mm)	Níveis	Acab.	Código
90	780	166	60	1	Preto	BN524.001.017
120	1103	166	60	1	Preto	BN524.001.018
150	1403	166	60	1	Preto	BN524.001.019
180	1726	166	60	1	Preto	BN524.001.020
90	780	166	310	2	Preto	BN525.001.013
120	1103	166	310	2	Preto	BN525.001.014
150	1403	166	310	2	Preto	BN525.001.015

### Mapa de Acessórios:

Mód. 90	AS	B	AS		
Mód. 120	B	AS	B		
Mód. 150	AS	B	AS	B	AS
Mód. 180	B	AS	B	AS	B



## Acessórios para Belnet



### AL Tabuleiro Universal



Acab. Código

Madeira BN520.001.001

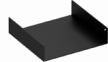
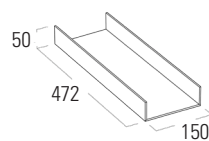

### AS Tabuleiro em U



Acab. Código

Madeira BN508.001.003

Preto BN508.001.007

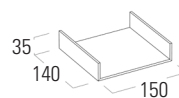

### AS Porta-Especiarias Pequeno



Acab. Código

Madeira BN508.002.003

Preto BN508.002.007

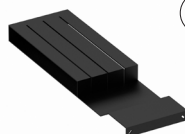
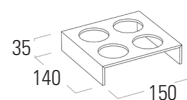

### B Porta-Facas



Acab. Código

Madeira BN521.003.001

Preto BN521.003.006

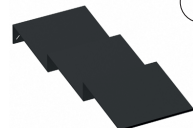
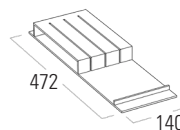

### B Divisor



Acab. Código

Madeira BN521.006.001

Preto BN521.006.006

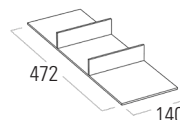

### B Porta-Especiarias Grande



Acab. Código

Madeira BN521.004.001

Preto BN521.002.004

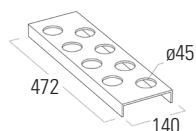

### B Porta-Garrafas



Acab. Código

Madeira BN521.001.002

Preto BN521.001.007

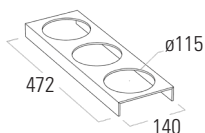

## Easy Wall Kitchen

EUREKA

Kit 60 inclui:

- Perfil inox.
- 4 ganchos.
- 2 suportes de conchas.
- Porta-rolos de cozinha.

Kit 90 inclui:

- Tudo do Kit 60.
- 1 prateleira.

L (mm)	Acab.	Código
600	Inox	EWK60
600	Inox	EWK90



## Sous Chef Rail

### Perfil de Alumínio

L (mm)	P (mm)	A (mm)	Acab.	Ganchos	Código
603	40	52	Preto	2	BP60
903	40	52	Preto	3	BP90

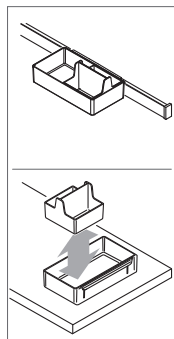

### Tabuleiro com Cesto Amovível

Inclui: tabuleiro amovível do perfil e cesto amovível do tabuleiro.

L (mm)	P (mm)	A (mm)	Acab.	Código
221	127	88	Preto	BOBP

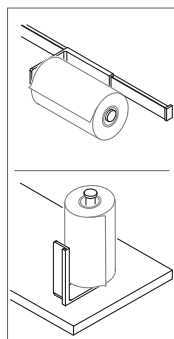

### Suporte de Rolo de Papel de Cozinha

Pode ser amovido e colocado em pé sobre uma superfície.

L (mm)	P (mm)	A (mm)	Acab.	Código
246	123	44	Preto	PRBP





## Barra de Proteção de Tampo

Barra cromada adesiva.  
Jogo de 4 barras.



L (mm)	P (mm)	A (mm)	Acab.	Código
300	12	6	Cromado	BPT

## Suporte em Inox para Copos

Módulo	L (mm)	P (mm)	Filas	Acabamento	
				Inox mate	Preto mate
60	568	280	4	SIC.280.M60.IM	SIC.280.M60.PM
90	868	280	6	SIC.280.M90.IM	SIC.280.M90.PM
120	1168	280	8	SIC.280.M120.IM	SIC.280.M120.PM
60	560	485	4	SIC.485.M60.IM	SIC.485.M60.PM
90	860	485	6	SIC.485.M90.IM	SIC.485.M90.PM
120	1160	485	8	SIC.485.M120.IM	SIC.485.M120.PM

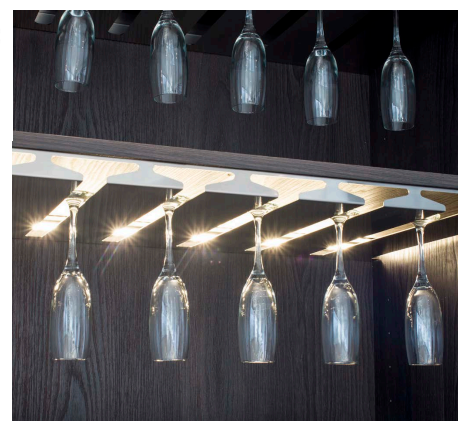

## Suporte em Inox para Garrafas

Módulo	L (mm)	P (mm)	Filas	Acabamento	
				Inox mate	Preto mate
60	560	309	5	SIG.M60.IM	SIG.M60.PM
90	860	309	8	SIG.M90.IM	SIG.M90.PM
120	1160	309	11	SIG.M120.IM	SIG.M120.PM

