



# INTERIORES PARA ARMÁRIOS

CASATREND | KESSEBOHRER



# LINHAS ARENA CLASSIC E STYLE



## Armário de 15

Extracção total soft-close.  
 Fixação na ilharga lateral.  
 Ajuste 3D.  
 Capacidade de 12 kg.  
 Push-to-open tipo 2 opcional.

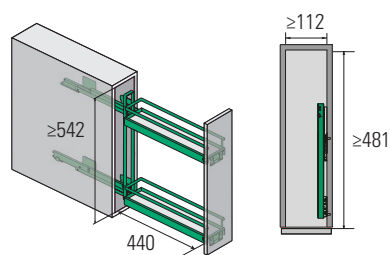

Módulo	L (mm)	P (mm)	A (mm)	Modelo	Acab.	Código
15	112	481	542	Classic	Cromado	K15.C.C
15	112	481	542	Style	Cromado	K15.S.C

Style





Classic

## Armário de 15 Porta-Panos

Extracção total soft-close.  
Fixação na ilharga lateral.  
Ajuste 3D.  
Capacidade de 12 kg.  
Push-to-open tipo 2 opcional.

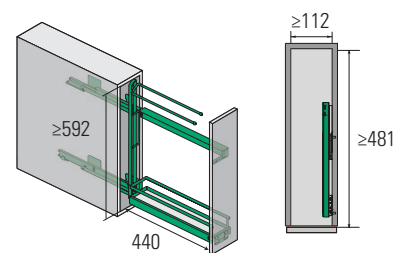

Módulo	L (mm)	P (mm)	A (mm)	Modelo	Acab.	Código
15	112	481	592	Classic	Cromado	K15PP.C.C

## Acessórios para Armários de 15



Separador Classic

K15.SC



Separador Style

K15.SSC

## Comfort II

Extracção total soft-close.  
Fixação na ilharga lateral.  
Altura dos cestos ajustável individualmente.  
Ajuste 3D.  
Capacidade de 20 kg.  
Modelo esquerdo ou direito.  
Push-to-open tipo 2 opcional.

Módulo	L (mm)	P (mm)	A (mm)	Modelo	Acab.	Código
20	145	496	654	Classic	Cromado	KC.C.20x.C
25	195	496	654	Classic	Cromado	KC.C.25x.C
30	245	496	654	Classic	Cromado	KC.C.30x.C
40	330	496	654	Classic	Cromado	KC.C.40x.C
20	145	496	654	Style	Cromado	KC.S.20x.B
25	195	496	654	Style	Cromado	KC.S.25x.B
30	245	496	654	Style	Cromado	KC.S.30x.B
40	355	496	654	Style	Cromado	KC.S.40x.B

Substituir x por E ou D para obter os códigos dos modelos Esquerdos e Direitos, respetivamente.



Style, modelo esquerdo

## Acessório para Comfort II



Prateleira para especiarias

KC.C.PE

## Junior III

Extracção total soft-close.  
 Fixação na base do armário.  
 Altura dos cestos ajustável individualmente.  
 Ajuste 3D.  
 Capacidade de 20 kg.

### Sets Youboxx Aplicáveis



Set 2

Set 3

Set 5

Módulo	L (mm)	P (mm)	A (mm)	Modelo	Acab.	Código
30	260	480	615	Classic	Cromado	KJ.C.30.C
40	360	480	615	Classic	Cromado	KJ.C.40.C
50	460	480	615	Classic	Cromado	KJ.C.50.C
60	560	480	615	Classic	Cromado	KJ.C.60.C
30	260	480	615	Style	Cromado	KJ.S.30.B
40	360	480	615	Style	Cromado	KJ.S.40.B



Style



## Portero III

1 dos cestos inferiores é amovível (com pega).  
 Cesto superior movível para mais fácil acesso aos inferiores.  
 Fixação na base do móvel.  
 Tabuleiros plásticos amovíveis e adequados para a máquina de lavar louça.  
 Inclui 8 divisórias.

L (mm)	P (mm)	A (mm)	Acab.	Código
276	468	510	Cromado	K.P.C

## Carousel 180°

Altura dos tabuleiros regulável.  
 Tabuleiros podem ser rodados em separado.

Porta	A (mm)	Modelo	Acab.	Código
45	627	Classic	Cromado e cinza	K180.C.C



Style



Style

## Revo 90°

A porta do armário recua suavemente e roda com o carousel.

Altura dos tabuleiros regulável.

Com soft-closing. Velocidade de fecho regulável.

Eixo de 660 a 860 mm.

D (mm)	Modelo	Acab.	Código
810	Classic	Cromado e cinza	KREVO.C.C
810	Style	Cromado e branco	KREVO.S.B

Style Esquerdo



## Carousel 270°

Altura dos tabuleiros regulável.

Tabuleiros podem ser rodados em separado.

Modelo	Acab.	Eixo	Diâmetro (mm)	
			700	820
Classic	Cromado e cinza	630 – 680	K270.C.70.C	K270.C.82.C
Classic	Cromado e cinza	685 – 735	K270.C.70.B.C	K270.C.82.B.C
Classic	Cromado e cinza	742 – 832	K270.C.70.M.C	K270.C.82.M.C
Classic	Cromado e cinza	839 – 889	K270.C.70.A.C	K270.C.82.A.C
Style	Cromado e branco	630 – 680	K270.S.70.B	K270.S.82.B
Style	Cromado e branco	685 – 735	K270.S.70.B.B	K270.S.82.B.B
Style	Cromado e branco	742 – 832	K270.S.70.M.B	K270.S.82.M.B
Style	Cromado e branco	839 – 889	K270.S.70.A.B	K270.S.82.A.B



Style

## Canto Mágico KB

Ângulo de abertura de 75°.

Capacidade de carga de 14 kg nos tabuleiros extraíveis e de 18 kg nos anteriores.

Com soft-closing.

Modelo esquerdo ou direito.

Porta	Modelo	Acab.	Código
45	Classic	Cromado e cinza	KCM.C.45x.C
45	Style	Cromado e branco	KCM.S.45x.B

Substituir x por E ou D para obter os códigos dos modelos Esquerdos e Direitos, respetivamente.

## Le Mans II

Altura dos tabuleiros regulável.

Ângulo de abertura de 85°.

Capacidade de carga de 25 kg por tabuleiro.

Com soft-closing (amortecedor vendido em separado).

Modelo esquerdo ou direito.

Modelos com eixo de 1.265 mm podem ter 2 ou 4 cestos.

Modelo	Acab.
Classic	Cromado e cinza
Style	Cromado e branco

Modelo	Eixo	Cestos	Porta			
			40	45	50	60
Classic	600 – 750	2	KL.C.B.40x.C	KL.C.B.45x.C	KL.C.B.50x.C	KL.C.B.60x.C
Classic	720 – 900	2	KL.C.M.40x.C	KL.C.M.45x.C	KL.C.M.50x.C	KL.C.M.60x.C
Classic	> 1 265	2	KL.C.A.40x.C	KL.C.A.45x.C	KL.C.A.50x.C	KL.C.A.60x.C
Classic	> 1 265	4	KL4.C.A.40x.C	KL4.C.A.45x.C	KL4.C.A.50x.C	KL4.C.A.60x.C
Style	600 – 750	2	–	KL.S.B.45x.B	KL.S.B.50x.B	KL.S.B.60x.B
Style	720 – 900	2	–	KL.S.M.45x.B	KL.S.M.50x.B	KL.S.M.60x.B
Style	> 1 265	2	–	KL.S.A.45x.B	KL.S.A.50x.B	KL.S.A.60x.B
Style	> 1 265	4	–	KL4.S.A.45x.B	KL4.S.A.50x.B	KL4.S.A.60x.B

Substituir x por E ou D para obter os códigos dos modelos Esquerdos e Direitos. respetivamente.



Style Esquerdo

### Amortecedores Le Mans II

Vendidos ao par.



Acab.	Código
Branco	KL.K2A.B
Cinza	KL.K2A.C

## Despensa 90

A altura dos tabuleiros é ajustável individualmente.

Fixação na base e topo do móvel.

Capacidade de 100 kg.

eTouch+ eletrónico opcional.

Módulo	P (mm)	Modelo	Acab.	Altura (mm)		
				1200 - 1600 4 cestos	1600 - 2000 6 cestos	1900 - 2300 6 cestos
30	500	Classic	Cromado e cinza	KD.C.B.30.C	KD.C.M.30.C	KD.C.A.30.C
40	500	Classic	Cromado e cinza	KD.C.B.40.C	KD.C.M.40.C	KD.C.A.40.C
30	500	Style	Cromado e branco	KD.S.B.30.B	KD.S.M.30.B	KD.S.A.30.B
40	500	Style	Cromado e branco	KD.S.B.40.B	KD.S.M.40.B	KD.S.A.40.B

## Acessórios

### Jogo Suporte Cestos

KD.JSC

### Platina União Frente

KD.PUF

### Sets Youboxx



Set 3



Set 5



### eTouch+ Eletrónico

KD.ETD90



Style



Style

## Tandem I

A altura dos tabuleiros é ajustável individualmente.

Fixação na base do móvel.

Ângulo de abertura: 110°.

Módulo	Capacidade (kg)	
	Tabuleiros da porta	Tabuleiros traseiros
45	20	50
60	25	60

Módulo	P (mm)	A (mm)	Modelo	Acab.	Código
45	500	1700	Classic	Cromado e cinza	KT.C.A.45.C
60	500	1700	Classic	Cromado e cinza	KT.C.A.60.C
45	500	1700	Style	Cromado e branco	KT.S.A.45.B
60	500	1700	Style	Cromado e branco	KT.S.A.60.B

## Convoy Lavido

Pull-out de 470 mm.

Altura dos tabuleiros ajustável individualmente.

Fixação na base do móvel e barra de estabilização.

Capacidade de 130 kg, incluindo a estrutura.

5 tabuleiros.

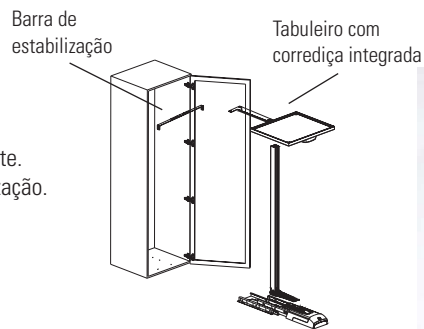

Módulo	P (mm)	Acab.	Altura (mm)	
			1800 - 2000	2000 - 2200
45	500	Vidro e branco	KCL.B.45	KCL.A.45
60	500	Vidro e branco	KCL.B.60	KCL.A.60



## Sets Youboxx

Conjuntos de caixas de arrumação para a Despensa Junior III e Despensa 90.



### Set 2

1 caixa de 3,2 L.  
1 prato de 1,1 L com porta-garrafas.  
3 divisórias pequenas + 3 grandes.  
2 estruturas de suporte.

KYB.2



### Set 3

2 caixas de 1 L + 2 de 2,1 L.  
2 tampas.  
1 divisória grande.  
2 corrediças.

KYB.3

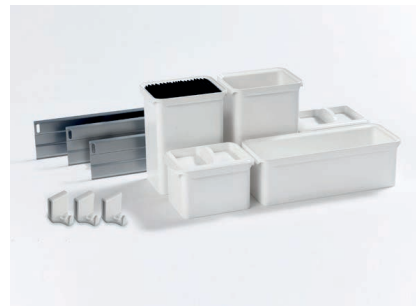

### Set 5

2 caixas de 1 L + 1 de 2,1 L + 2 de 2 L.  
1 caixa para facas.  
2 tampas.  
3 corrediças.  
3 ganchos para tábuas de corte.

KYB.5

## Acessórios

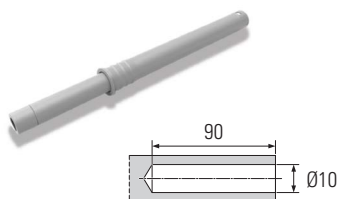

### Push-to-Open Tipo 2

K.E.T2

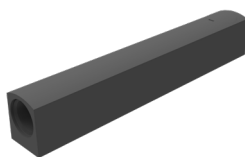

### Base para Push-to-Open Tipo 2

K.BE

## Modelos



### Classic

Cromado com fundo cinza



### Style

Cromado com fundo branco





## LINHA ARENA PURE

### Le Mans II Pure

Altura dos tabuleiros regulável.  
 Ângulo de abertura de 85°.  
 Capacidade de carga de 25 kg por tabuleiro.  
 Com soft-closing e ClickFixx.  
 Modelo esquerdo ou direito.  
 Para ilhargas de 16 e 19 mm.  
 Antideslizante.



Versão Direita



Acab.	Eixo	45	Porta	
			50	60
Antracite	600 – 750	K.LP.B.45x.A	KL.PB.50x.A	KL.PB.60x.A
Antracite	720 – 900	K.LP.M.45x.A	KL.PM.50x.A	KL.PM.60x.A
Antracite	≥ 1250	K.LP.A.45x.A	KL.PA.50x.A	KL.PA.60x.A

Substituir x por E ou D para obter os códigos dos modelos Esquerdos e Direitos, respetivamente.



## Carousel 270° Pure

Altura dos tabuleiros regulável.  
 Capacidade de carga de 25 kg por tabuleiro.  
 Eixo cromado e tabuleiros antracite.  
 Para ilhargas de 16 e 19 mm.  
 Diâmetro de 82 mm.



Acab.

Eixo

Código

Antracite 685 – 735 K270.P.82.B.A

Antracite 742 – 832 K270.P.82.M.A

Antracite 839 – 889 K270.P.82.B.A

## Tandem II Pure

A altura dos tabuleiros, ambos os interiores e os da porta, é regulável.

Com push-to-open, soft-closing e ClickFixx.

Para ilhargas de 16 e 19 mm.

Antideslizante.

Reversível

Equipado com 5 cestos.

Expulsor tipo 3 opcional.



Módulo



A (mm)



Acab.

Código

45 1700 Antracite KT.P.45.A

60 1700 Antracite KT.P.60.A



## Tandem II Side Pure

Altura dos tabuleiros regulável.  
 Requer um espaço frontal livre de 175 mm.  
 Com push-to-open e ClickFixx.  
 Para ilhargas de 16 e 19 mm.  
 Antideslizante.  
 Reversível.  
 Equipado com 6 cestos.  
 Push-to-open tipo 2 opcional.



Módulo



A (mm)



Acab.

Código

45 1700 Antracite KTSA.P.45.A

60 1700 Antracite KTSA.P.60.A



## Despensa 90 Pure

Permite instalação apenas com tabuleiros ou com tabuleiros e o conjunto Youboxx 5. Com soft-closing e ClickFixx. Corrimento das corredeiras sincronizado. Para ilhargas de 16 e 19 mm. Antideslizante. eTouch+ eletrónico opcional.



Módulo

A (mm)

Acab.

Código

30

1900 - 2300

Antracite

KD.PA.30.A

40

1900 - 2300

Antracite

KD.PA.40.A



eTouch+

KD.ETD90

## Armário Junior III Pure

Permite instalação apenas com tabuleiros ou com tabuleiros e o conjunto Youboxx 5. Com soft-closing e ClickFixx. Para ilhargas de 16 e 19 mm. Antideslizante.



Módulo

A (mm)

Acab.

Código

30

631

Antracite

KJ.P.30.A

40

631

Antracite

KJ.P.40.A



## Tandem Side Pure Baixo

Altura dos tabuleiros regulável. Requer um espaço frontal de 175 mm livre. Com push-to-open e ClickFixx. Para ilhargas de 16 e 19 mm. Antideslizante. Push-to-open tipo 2 opcional. Equipado com 3 cestos.



Módulo

A (mm)

Acab.

Código

45

600

Antracite

KTSB.P.45.A

60

600

Antracite

KTSB.P.60.A

## Turnmotion II Pure

Regulável em altura.  
Para ilhargas de 16 e 19 mm.  
Antideslizante.

Módulo	A (mm)	Acab.	Código
60	383	Antracite	KTM.P.60.A



## Acessórios



### Youboxx Set 5 Antracite

2 caixas de 1 L + 1 de 2,1 L + 2 de 2 L.  
1 caixa para facas.  
2 tampas.  
3 corrediças.  
3 ganchos para tábuas de corte.

KYB.5A

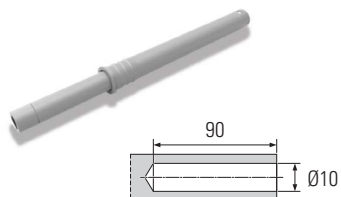

### Push-to-Open Tipo 2

Expulsador	K.E.T2
Base	K.BE

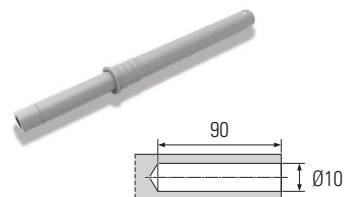

### Push-to-Open Tipo 3

Expulsador	K.E.T3
Base	K.BE

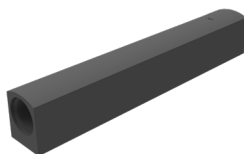

### Base para Push-to-Open Tipo 2/3

K.BE



# LINHA K

## K-Line 15 3DX

Regulação 3D.

Com push-to-open, soft-closing e ClickFixx.

Para ilhargas de 16 e 19 mm.

Inclui guia de extração total GRASS.

Push-to-open tipo 2 opcional.

Separador opcional.

Tapete anti-deslizante incluído.



Módulo



A (mm)



Acab.

Código

15

525

Antracite

K.KL.15.A

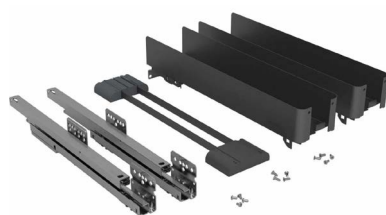



## K-Line Base

Com push-to-open, soft-closing e ClickFixx.  
 Para ilhargas de 16 e 19 mm.  
 Push-to-open tipo 2 opcional.  
 Separador opcional.  
 Tapete antiderrapante incluído.

Módulo	A (mm)	Acab.	Código
20	523	Antracite	K.KL.20.A
30	523	Antracite	K.KL.30.A
40	523	Antracite	K.KL.40.A

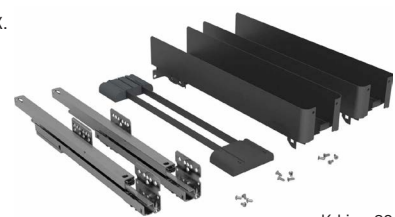

K-Line 20

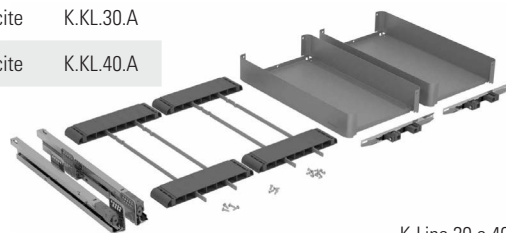

K-Line 30 e 40

## K-Line Base — Suplemento H80

Compatível com o K-Line Base (módulos de 20, 30 e 40) e com o K-Line para Pão (módulos de 30 e 40).

L (mm)	A (mm)	Acab.	Código
150	190	Antracite	K.KL.S80.A



## K-Line para Pão

Com push-to-open, soft-closing e ClickFixx.  
 Para ilhargas de 16 e 19 mm.

Módulo	A (mm)	Acab.	Código
30	523	Antracite	K.KL.P30.A
40	523	Antracite	K.KL.P40.A



## K-Line Cooking Agent

Com push-to-open e soft-closing.  
Para ilhargas de 16 e 19 mm.  
Push-to-open tipo 3 opcional.

M	A (mm)	Acab.	Código
30	625	Antracite	K.KL.CO.A



## K-Line Cleaning Agent

Com soft-closing.  
Para ilhargas de 16 e 19 mm.

L (mm)	A (mm)	Acab.	Código
298	480	Antracite	K.KL.CLA.A



## Acessórios

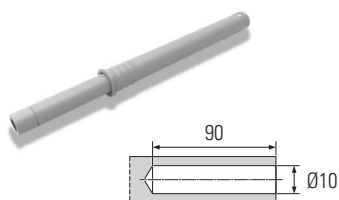

Push-to-Open Tipo 2

K.E.T2

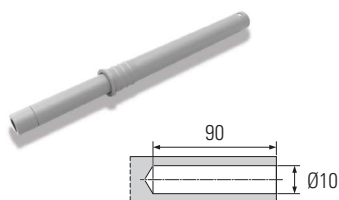

Push-to-Open Tipo 3

K.E.T3

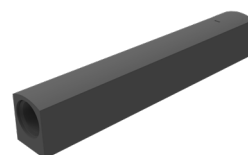

Base para  
Push-to-Open Tipo 2

K.BE



Separador

Para K-Line  
15, 20, 30 e 40

K.SEP



## K-Line Side

Conjunto de peças para uma arrumação inteligente de produtos de limpeza.







Set de guias



Estante



Estante com corrimão



Perfil de suporte com 4 ganchos



Barra para 5 ganchos



Porta-rolos de cozinha

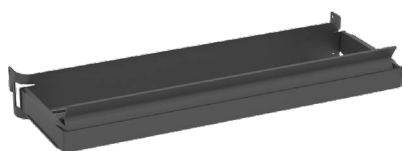

Porta-rolos de cozinha com lâmina de corte

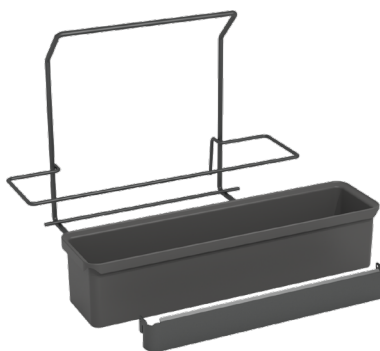

Cesto portátil de limpeza



Perfil de suporte com recipiente



Perfil de suporte com 2 recipientes



Barra para 5 ganchos para montar na lateral

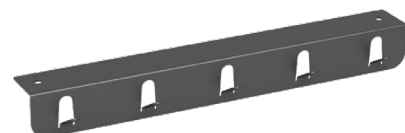

Barra para montagem no teto



Suporte para mangueira de aspirador



Recipiente para utensílios



Conjunto para guardar caixas de bebidas

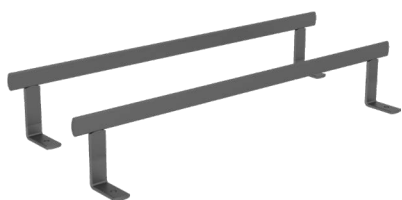

Conjunto de tabuleiros para cesto de roupa



Suporte para tábua de engomar ou escadote

Produto	Requer set de guias	 L (mm)	 P (mm)	 A (mm)	 Acab.	Código
Set de guias	—	1073	—	—	Antracite	KLS.SG
Estante	Sim	350	110	65	Antracite	KLS.E
Estante com corrimão	Sim	350	110	65	Antracite	KLS.EC
Perfil de suporte com 4 ganchos	Sim	350	45	60	Antracite	KLS.PS4G
Barra para 5 ganchos	Sim	350	32	50	Antracite	KLS.B5G
Porta-rolos de cozinha	Sim	350	120	65	Antracite	KLS.PR
Porta-rolos de cozinha com lâmina de corte	Sim	350	145	70	Antracite	KLS.PRL
Cesto portátil de limpeza	Sim	442	160	315	Antracite	KLS.CPL
Perfil de suporte com recipiente	Sim	350	95	138	Antracite	KLS.PSR
Perfil de suporte com 2 recipientes	Sim	440	95	116	Antracite	KLS.PS2R
Barra para 5 ganchos para montar na lateral	Não	350	—	—	Antracite	KLS.B5GL
Barra para montagem no teto	Não	350	—	—	Antracite	KLS.B5GT
Suporte para mangueira de aspirador	Não	150	63	70	Antracite	KLS.SMA
Recipiente para utensílios	Não	255	140	300	Antracite	KLS.RU
Conjunto para guardar caixas de bebidas	Não	557	355	95	Antracite	KLS.CB
Conjunto de tabuleiros para cesto de roupa	Não	—	—	—	Antracite	KLS.TCR
Suporte para tábua de engomar ou escadote	Não	—	—	—	Antracite	KLS.S