

Slim Drawer System SB1900 - A01

Slim box, height 86mm



SOFT-CLOSING

- Basic, height 86mm.
- Loading capacity: 40Kg.
- Wide range of depth from 270mm to 550mm.
- Two colors in stocking, black and white. Other colors on request.
- Front convenient fine adjustment mechanism integrated.
Up & down ± 1.5 mm, left & right ± 1.5 mm.
- Synchronization mechanism of the slides stabilizes the sliding motion and eliminates noises from the living space.





SB1900-A01

Length	Cover	
	White	Black
270mm	554.111.010	554.121.010
300mm	554.111.011	554.121.011
350mm	554.111.012	554.121.012
400mm	554.111.013	554.121.013
450mm	554.111.014	554.121.014
500mm	554.111.015	554.121.015
550mm	554.111.016	554.121.016

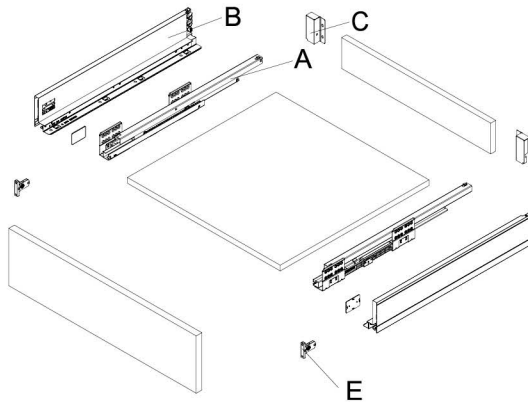
Product information

Components view



A	SS1801-S Drawer slide L/R	
A ► Page - B.102		
B	SS1900-B86 Side wall L/R	
C	SS1900-L86 Back panel connector L/R	
B, C ► Page - B.52		
E	SS1900-TA1 Front connector	
	SS1900-TA2 Quick mount front connector	
E ► Page - B.54		

Mounting

Cabinet space requirements

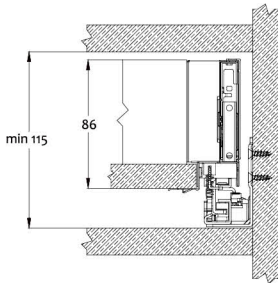

Front connector panel installation dimensions

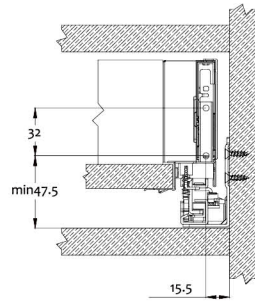

Front panel drilling dimensions

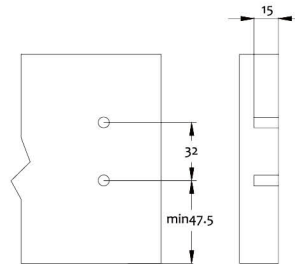

Back panel installation dimensions

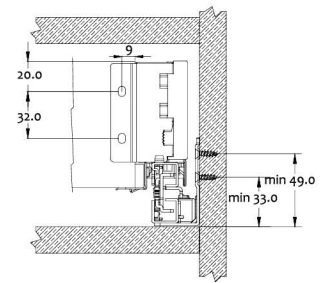

Drawer slide installation dimensions

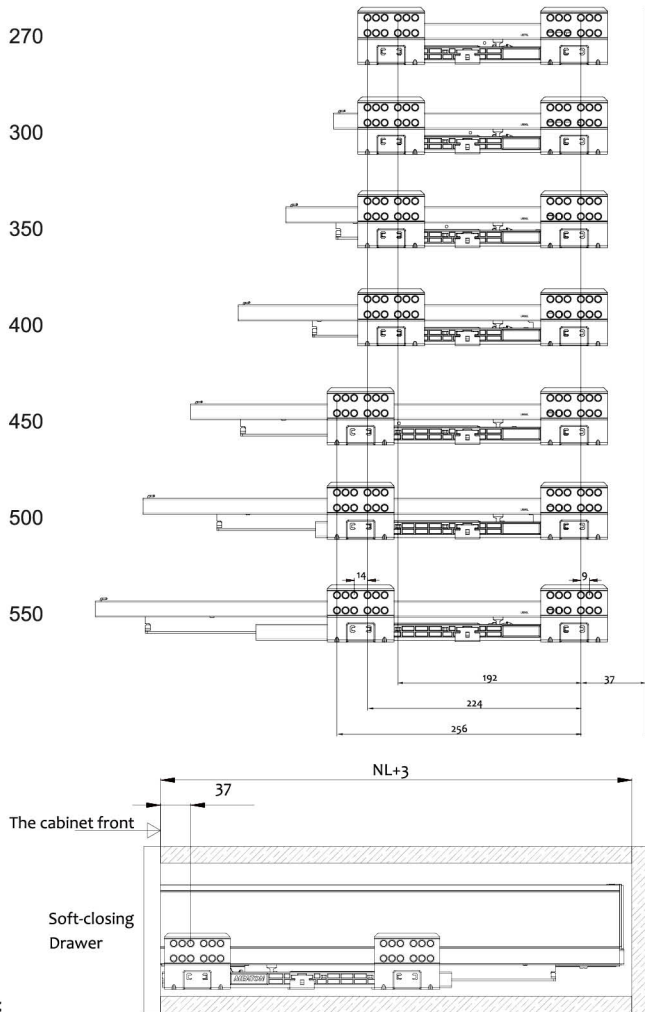

Cutting dimensions for back panel

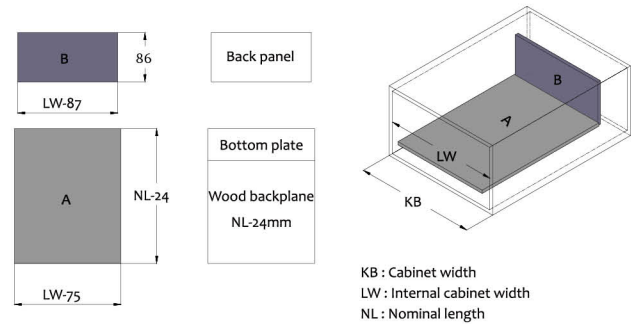

Space required

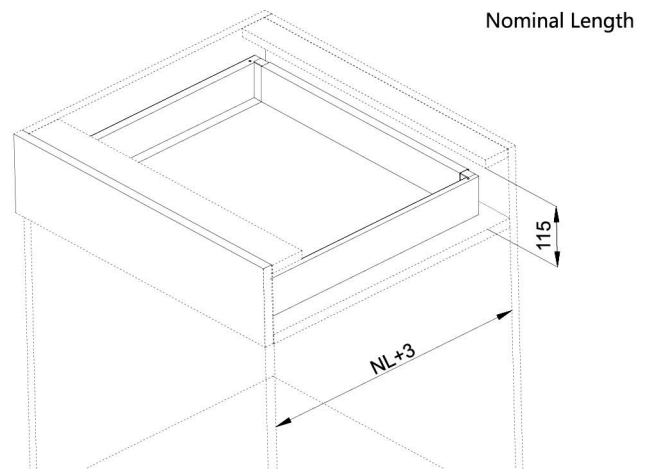



Inner box, height 86mm



SOFT-CLOSING

- Inner drawer, height 86mm.
- Loading capacity: 40Kg.
- Wide range of depth from 270mm to 550mm.
- Two colors in stocking, black and white. Other colors on request.
- Front convenient fine adjustment mechanism integrated.
Up & down ± 1.5 mm, left & right ± 1.5 mm.
- Synchronization mechanism of the slides stabilizes the sliding motion and eliminates noises from the living space.

SB1900-A02

SB1900-A02H



Length	Cover		Length	Cover	
	White	Black		White	Black
270mm	554.111.020	554.121.020	270mm	554.111.120	554.121.120
300mm	554.111.021	554.121.021	300mm	554.111.121	554.121.121
350mm	554.111.022	554.121.022	350mm	554.111.122	554.121.122
400mm	554.111.023	554.121.023	400mm	554.111.123	554.121.123
450mm	554.111.024	554.121.024	450mm	554.111.124	554.121.124
500mm	554.111.025	554.121.025	500mm	554.111.125	554.121.125
550mm	554.111.026	554.121.026	550mm	554.111.126	554.121.126

Product information

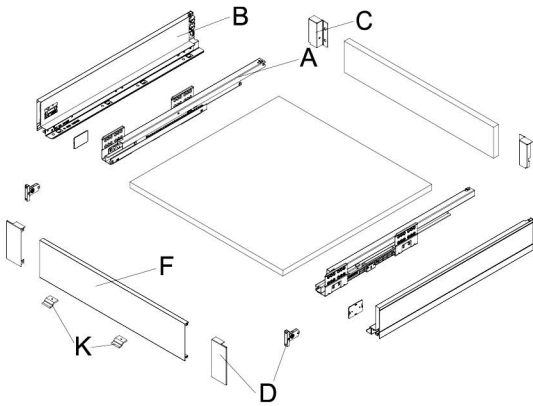

Components view

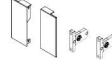

- A** **SS1801-S**
Drawer slide L/R 
A ► Page - B.102

- B** **SS1900-B86**
Side wall L/R 
- C** **SS1900-L86**
Back panel connector L/R 
B, C ► Page - B.52

- D** **SS1900-F86**
Inner drawer front connector L/R 
- SS1900-F86H**
Inner drawer front connector (handle) L/R 
D ► Page - B.53

- F** **SS1800-04**
Inner drawer front panel 
- SS1800-04H**
Inner drawer front panel (handle) 
F ► Page - B.104

- K** **SS1800-37**
Front panel bracket to bottom panel 
K ► Page - B.105

Mounting

Cabinet space requirements

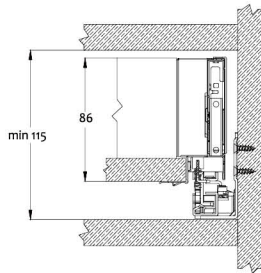

Back panel installation dimensions

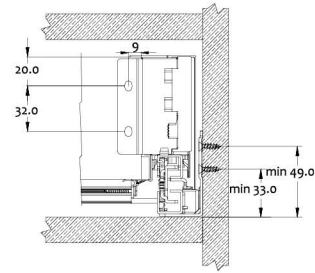

Internal front panel DIY cut

Planar

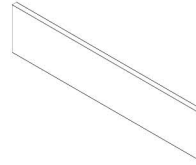

Handle

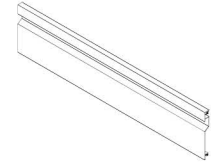

DIY cut: LW - 98mm

Drawer slide installation dimensions

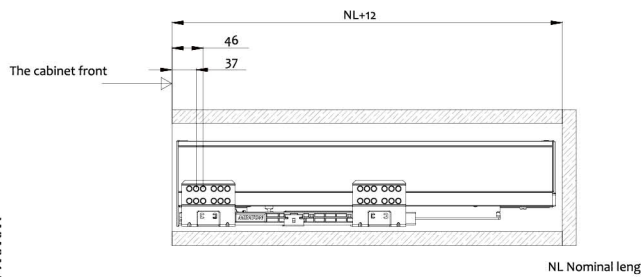
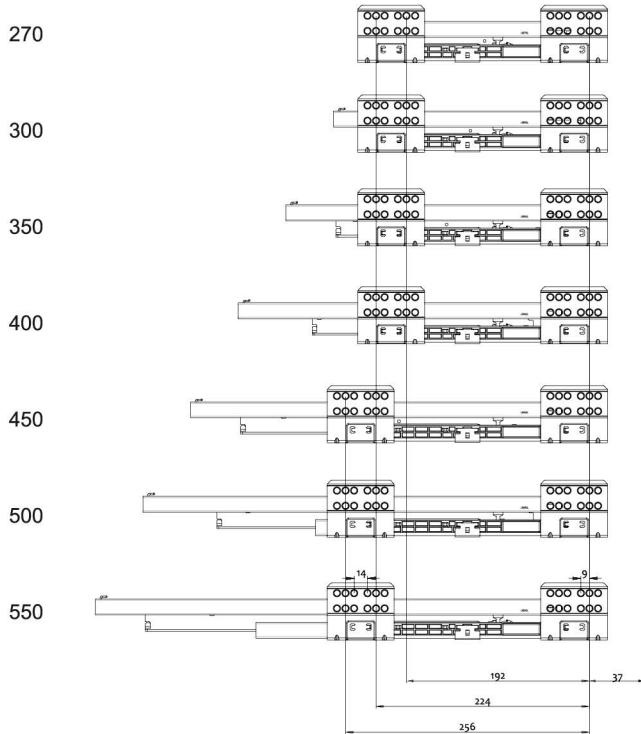

Cutting dimensions for back panel

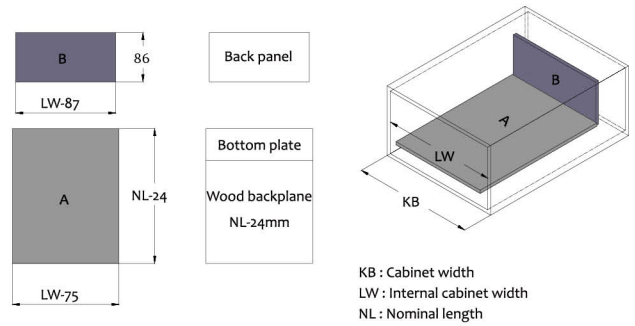

Space required

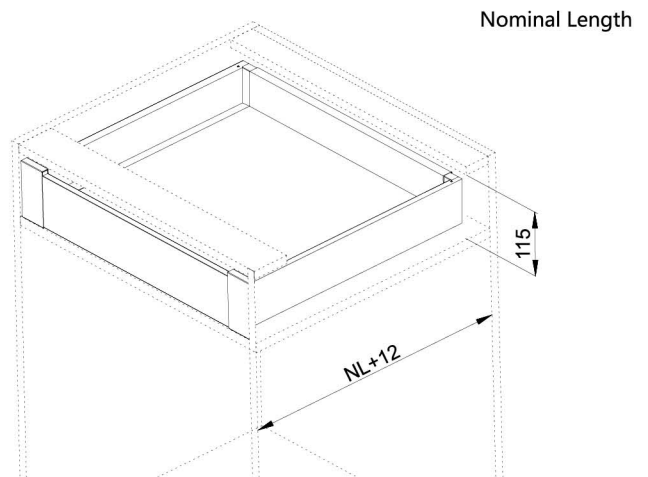

Slim Drawer System SB1900 - A03

Inner box with extended front glass, height 86mm



SOFT-CLOSING



- Inner drawer, height 86mm.
- Loading capacity: 40Kg.
- Wide range of depth from 270mm to 550mm.
- Two colors in stocking, black and white. Other colors on request.
- Front convenient fine adjustment mechanism integrated.
Up & down ± 1.5 mm, left & right ± 1.5 mm.
- Synchronization mechanism of the slides stabilizes the sliding motion and eliminates noises from the living space.

SB1900-A03

Length	Cover	
	White	Black
270mm	554.111.030	554.121.030
300mm	554.111.031	554.121.031
350mm	554.111.032	554.121.032
400mm	554.111.033	554.121.033
450mm	554.111.034	554.121.034
500mm	554.111.035	554.121.035
550mm	554.111.036	554.121.036

Product information

Components view

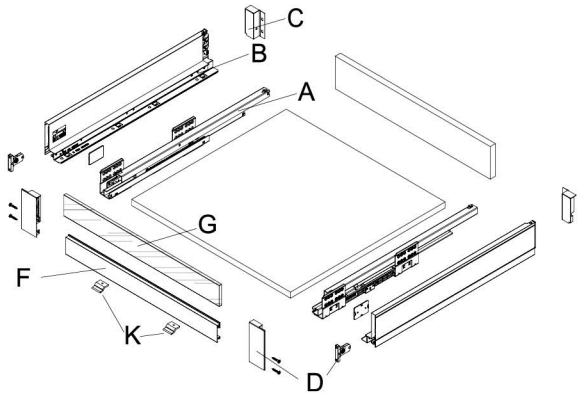

G SS1900-20-A







Material - aluminium alloy

Inner drawer extended front panel

Color - White / Black

Automatically cut - the cabinet body width LW - 85

Length	Cover	
	White	Black
600mm	554.905.161	554.905.162
800mm	554.905.181	554.905.182
900mm	554.905.191	554.905.192
1000mm	554.905.101	554.905.102
1200mm	554.905.121	554.905.122

- A SS1801-S**
 Drawer slide L/R

 A ▶ Page - B.102
- B SS1900-B86**
 Side wall L/R

 B, C ▶ Page - B.52
- C SS1900-L86**
 Back panel connector L/R

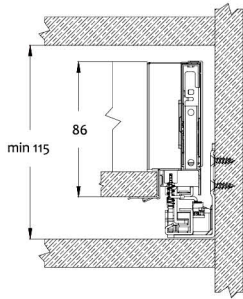
 B, C ▶ Page - B.52
- D SS1900-F86G**
 Inner drawer front connector L/R

 ▶ Page - B.53
- F SS1900-04**
 Inner drawer front panel

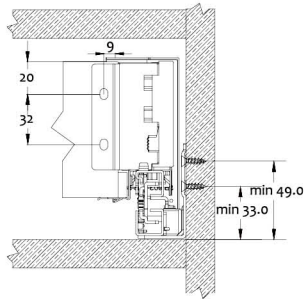
 F, G1 ▶ Page - B.55
- G1 SS1900-20-AS/ SS1900-20-AT**
 Inner drawer extended front glass

 F, G1 ▶ Page - B.55
- K SS1800-37**
 Front panel bracket to bottom panel

 K ▶ Page - B.105

Mounting

Cabinet space requirements



Back panel installation dimensions



Internal front panel DIY cut

Planar



DIY cut: LW - 98mm

Drawer slide installation dimensions

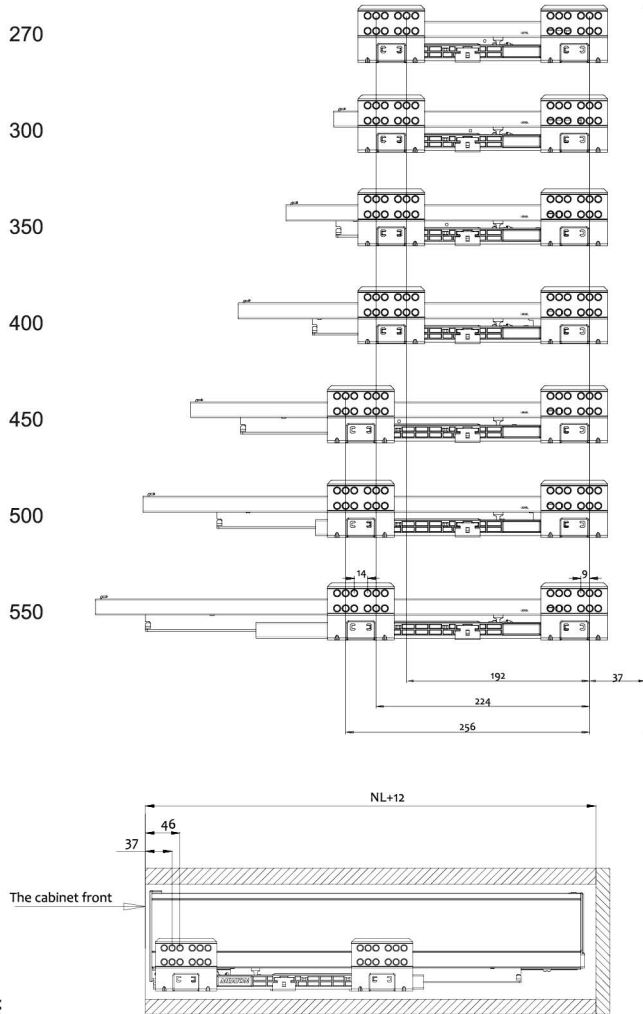

Cutting dimensions for back panel

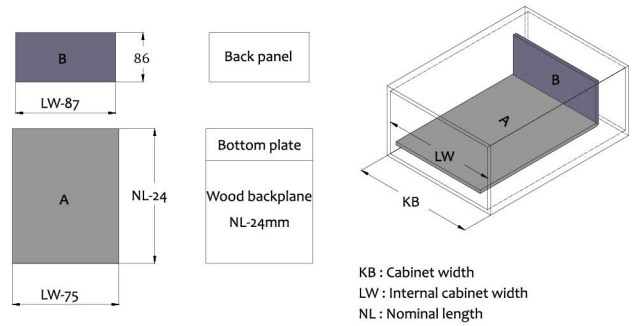

Space required

