

The K point
of view

Sliding
DOOR
systems

Krona
Koblenz

KRONA KOBLENZ

For over 30 years we have been manufacturing adjustable concealed hinges and cutting-edge solutions for doors and furniture.

We plan our success and develop each activity in Coriano, Italy, in Krona Koblenz headquarter. Our Customers' needs are the background of our research.

Our Partners

We support our customers and partners because the best achievements come from their feedback: experience sharing gives us the inspiration to create new solutions and the motivation to push ourselves into new challenges.

Research and Development

The idea development is a particular and very important phase; for this reason, the development is supported by rapid prototyping machines and test benches compliant with the relevant regulations to obtain the best results.

Patents

We strongly believe in our ideas, this is why many of our products are protected by international patents.

Corporate Certifications



Krona Koblenz SpA adopts ISO 9001 certified quality management system, ensuring controlled processes, operational efficiency and continuous improvement, in order to offer products and services to the customers that meet the highest international standards.



KRONA KOBLENZ, Coriano, Italy

ONLINE CONSULTING

Are you working on a project and are you looking for a solution or an alternative to a problem?

Do you have doubts about the assembly or adjustment of one of our systems?
We have the right service for you!



Book a consultation with one of our experts by fixing the time that best suits you: we will be at your disposal to find a solution at any stage of your project. We will support you in the preliminary phase, in the executive design phase, but also during the installation or after-sales assistance without leaving your customers alone.

BOOK A CONSULTATION



SERVICES FOR YOU

We have designed and created tools and services to simplify the work of those who have decided to apply our products.

Catalogue

The catalog you are browsing will show you the entire range of systems for sliding doors, folding door systems and finally swinging door systems.

This catalog offers you a very wide range of solutions, and in order to make it easier for you to read it and identify the items suitable for your needs, we have divided the section of sliding door systems into 4 series which vary based on their different and particular technical characteristics.

The series that make up the sliding system range are: premium, basic, outdoor and design

Within each series, there has been created a page for each set we sell; each set has a detailed drawing where it is really easy to identify the components it is made of. Furthermore, thanks to the “set matching tables”, it will be quite easy to choose all the necessary components to create the sliding solution suitable for your project.

Website

Our website is now very easy to browse: starting from your needs, in a few clicks we will guide you until you get a selection of articles suitable for your needs. Try it now!

Design utilities

Simplified design with the new download area where you can download 3D, 2D CAD and media files, assembly instructions and much more.

Online consulting

Do you still have questions or did anything go wrong?

There is a technical sales consultant ready to help you, book a free consultation at our website. We are sure that we will find a suitable solution for you.

Product schooling

In our new “product schooling” section there are guidelines, tips, articles on carpentry and architecture as well as terms and definitions guide.

Training

News, updates and practical tests directly with the product are possible with our K-Mobile: a car equipped with our product range is on the move throughout the country with our sales technicians who visit our partners.

Interactive PDF catalog



Do you want to get the catalogue always updated? We offer an interactive PDF for easy consultation even from smartphones and laptop. Scan the QR Code and add the link to your favorites to always access the latest version of our catalogue.



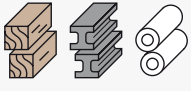

Page

6 Terms and definitions

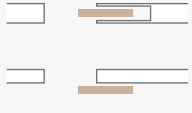
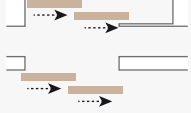
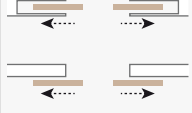

8 Premium Series
Sliding systems for wooden, metal or PVC doors

<p>DOOR MATERIAL Wood, Metal and PVC</p> 	<p>ROLLERS Body: Zamak Wheels: 2 or 4 Ball bearings: 2 or 4</p> 	<p>SLIDING Standard</p> 	<p>SLIDING Telescopic doors</p> 	<p>SLIDING Simultaneous opening</p> 
<p>SOFT-CLOSE</p> <p>ABS ●●●●●●●●</p> <p>DOUBLE</p> <p>Type: Mechanic Covering: Steel</p>		<p>MAGNETIC SOFT AND SELF CLOSING MECHANISM</p> <p>ABS ●●●●●●●●</p> <p>SINGLE / DOUBLE</p> <p>Type: Magnetic Covering: Steel</p>		

52 Serie Premium
Glass door sliding systems

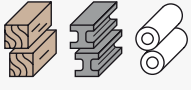

<p>DOOR MATERIAL Glass</p> 	<p>ROLLERS Body: Zamak Wheels: 2 or 4 Ball bearings: 2 or 4</p> 	<p>SLIDING Standard</p> 
<p>SOFT-CLOSE</p> <p>ABS ●●●●●●●●</p> <p>DOUBLE</p> <p>Type: Mechanic Covering: Steel</p>		<p>MAGNETIC SOFT AND SELF CLOSING MECHANISM</p> <p>ABS ●●●●●●●●</p> <p>SINGLE / DOUBLE</p> <p>Type: Magnetic Covering: Steel</p>

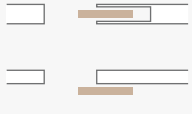
78 Serie Basic
Sliding systems for wooden, metal and PVC doors



<p>DOOR MATERIAL Wood, Metal and PVC</p> 	<p>ROLLERS Body: POM Wheels: 4 Ball bearings: 2</p> 	<p>SLIDING Standard</p> 	<p>SOFT-CLOSE</p> <p>ABS ●●●●●●●●</p> <p>SINGLE</p> <p>Type: Mechanic Covering: Plastic</p>
---	--	--	--

Index
Terms
Slider Wood Premium
Slider Glass Premium
Basic Slider
Outdoor Slider
Design Slider
Optional
Folding solutions
Swinging solutions

108 Serie Outdoor
Sliding systems for wooden, metal and PVC doors

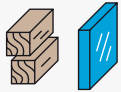

<p>DOOR MATERIAL Wood, Metal and PVC</p> 	<p>ROLLERS Body: Zamak or Aluminium Wheels: 2</p> 	<p>SLIDING Outdoor</p> 
---	--	---

128 Serie Design
Sliding systems for wooden and glass doors

<p>DOOR MATERIAL Wood, Glass</p> 	<p>SLIDING Invisible</p> 	<p>SLIDING On view</p> 
--	--	--

144 Optional

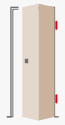
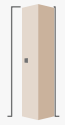
154 Folding door systems

<p>DOOR MATERIAL Wood, Metal and PVC</p> 	<p>FOLDING Rebate (External hinge)</p> 	<p>FOLDING Flush (Inside hinge)</p> 	<p>NUMBER OF DOOR LEAF</p>  <p>minimum 2 maximum 8</p>
---	---	--	--

184 Swinging-Sliding Doors Systems

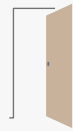
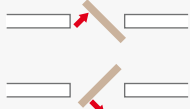
<p>DOOR MATERIAL Wood</p> 	<p>APPLICATION Swinging</p> 	<p>OPENING Push / Pull</p> 	<p>SOFT-CLOSE</p> <p>ABS ●●●●●●●●</p> <p>SINGLE</p> <p>Type: Mechanic Covering: Plastic</p>
--	--	---	---

Sliding door systems

• SLIDING



Standard

The solution that allows the creation of pocket and wall mounted sliding doors. It can be made with a **usual bracket** fixed in the upper part of the door or **embedded** in the door leaf when applied as flush to upper track.

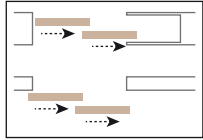

Parallel doors

The sliding solution that allows the creation of bypassing parallel doors, which slide in the same direction, both as a pocket and a wall mounted solution.

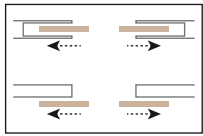

Simultaneous opening

The sliding solution that allows the creation of two coplanar doors with a synchronized and simultaneous opening, which even lets you only move one door. Both pocket door and wall mounted door solution.



Invisible

The solution that allows the creation of the wall mounted sliding doors with an invisible sliding system.



Outdoor

The solution that allows the creation of sliding doors suitable for outdoor conditions.



On view

The solution that allows the creation of the wall mounted sliding doors with a visible track and rollers. Suitable for wooden and glass doors.

• SOFT-CLOSE



Soft close device for soft opening or closing. The body made of POM is integrated in the track.



Soft close device for soft opening and closing. Aluminum body, silent, integrated in the track and ultra-compact for installation also on narrow door leaf.

• DOOR MATERIAL



Wood



Metal



PVC



Glass

• MAGNETIC SOFT AND SELF CLOSING MECHANISM



Magnetic soft and self opening or closing mechanism, extremely silent, with a metal body integrated into the track. The compact form of the system allows to apply it on door leaves with a reduced width.



Magnetic soft and self opening and closing mechanism, extremely silent, with a metal body integrated into the track. The compact form of the system allows to apply it on door leaves with a reduced width.

• WOOD FIXING

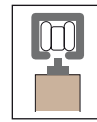

Standard double-entry bracket

An anchor bracket fixed in the upper part of the door leaf. The two way use allows both its front and lateral mounting.

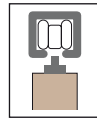

Standard single-entry bracket

An anchor bracket fixed in the upper part of the door leaf.

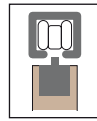

Bracket for minimal clearance installation

A bracket embedded into the panel to make the sliding door flush to the upper track.

• GLASS FIXING

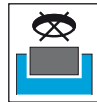

Clamp not requiring perforated glass

It DOES NOT require a safety hole in the glass during the installation.

• SHOCK ABSORBER

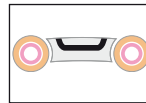

An element made of TPE (thermoplastic material) that allows the roller to absorb irregularities when sliding.

Folding door systems

• FOLDING

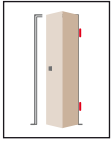

External shutter (External hinge)

Hinged doors. With this application the hinge is installed outside of the jamb.

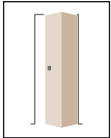

Flush to wall (Internal hinge)

When the door is closed, it is flush to the wall. In this case the hinge is installed inside the jamb.

• OVERALL DIMENSIONS WHEN OPEN

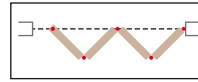

Totally in the same room

The space occupied by the opened doors is totally in the same room.

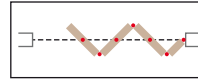

Both rooms

The space occupied by the opened doors is half-divided in 2 rooms.

Swinging-Sliding doors systems

• OPENING BY PUSH AND PULL

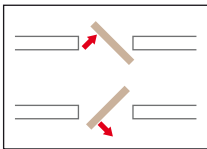

The opening can be carried out in both directions, both by pushing on the door handle and pulling it.

• BRACKET EMBEDDED IN THE DOOR

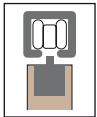

A door embedded bracket allows to have a reduced upper gap.

• DOOR LEAF WIDTH

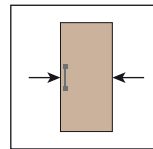

The indicated types of width are available in stock.
For other sizes get in touch with Krona Koblenz.

• UNIVERSAL

It means that the width can be tailor-made within a specific range. It allows to have an easier suitability for any standard door width.

PREMIUM SERIES

Sliding systems for wooden,
metal or PVC doors



PLUS:

1. **ROLLER** made of Zamak body and 4 POM (Polyoxymethylene) wheels with a ball bearing for a smooth sliding.
2. **SHOCK ABSORBER**, a TPE shock absorber in the roller body allows a perfect sliding absorbing small unevenness in the track.
3. **SOFT CLOSE DEVICE** for soft opening and closing. Aluminum body, silent, integrated in the track and ultra-compact for installation also on narrow door leaf.
4. **MAGNETIC SOFT AND SELF OPENING AND CLOSING MACHANISM**, extremely silent, with a metal body integrated into the track. The compact form of the system allows to apply it on door leaves with a reduced width.
5. **FIXING**
 - **DOUBLE-ENTRY BRACKET** for front and side door leaf hanging.
 - **BUILT-IN BRACKET FOR MINIMAL CLEARANCE INSTALLATION**, Adjustable from the side and made of two pieces for an easy installation. The casing is built-in a milled door leaf. The hanging part aconnected to the roller slides in the casing hanging the door leaf.
6. **ADJUSTABLE END-STOP**, the unfasten force is adjustable by screwing a set screw.
7. **ADJUSTABLE FLOOR GUIDE**, the buttonholes allow to adjust the guide positioning. The selection - among different diameters - of the plastic wheel that best fits the door leaf bottom milling provide a fluid sliding.
8. Option to complete the kit with accessories.

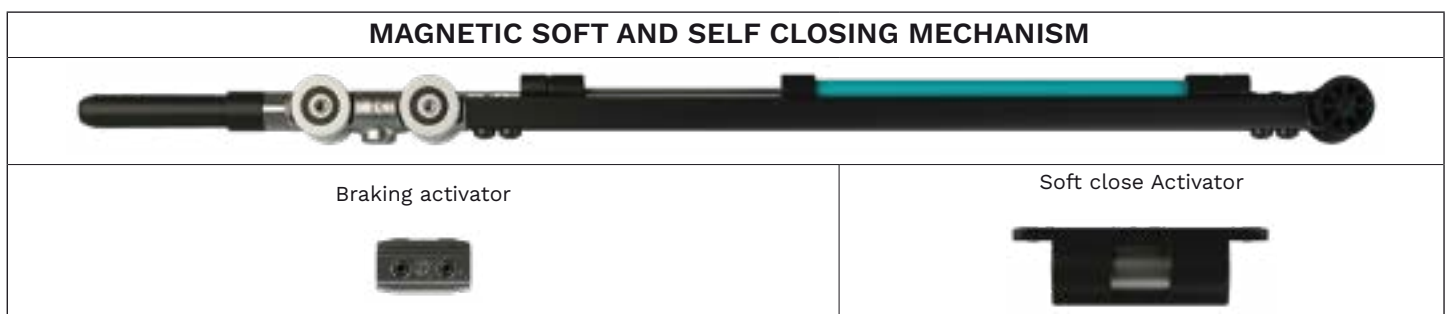
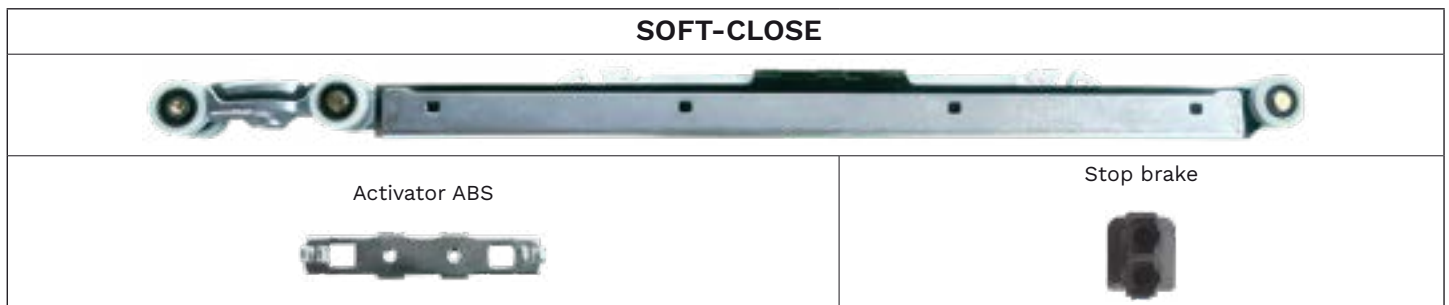
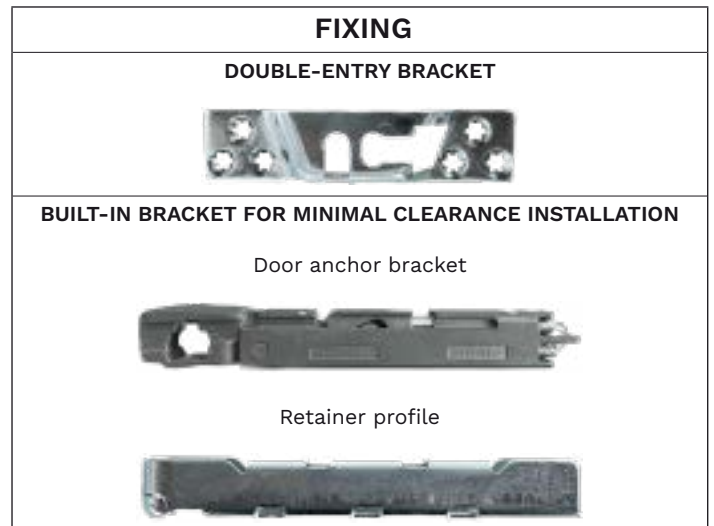

System	Door material	Sliding	Fixing	Soft and self closing mechanism	Page
MAGNUS		Standard 	Standard double-entry bracket or Bracket for minimal clearance installation	Magnetic	12
0500		Standard 	Standard double-entry bracket	Cushioned	20
0600		Standard 	Bracket for minimal clearance installation	Cushioned	36
0550		Simultaneous opening 	Standard double-entry bracket	No	44
0560		Telescopic doors 	Standard double-entry bracket	No	48

TERMS AND DEFINITIONS

• DOOR MATERIAL

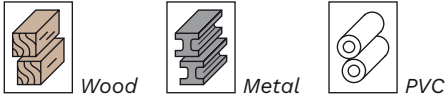

• SLIDING



Standard

The solution that allows the creation of pocket and wall mounted sliding doors. It can be made with a **usual bracket** fixed in the upper part of the door or **embedded** in the door leaf when applied as flush to upper track.

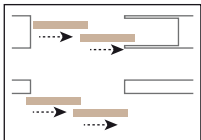

Parallel doors

The sliding solution that allows the creation of bypassing parallel doors, which slide in the same direction, both as a pocket and a wall mounted solution.

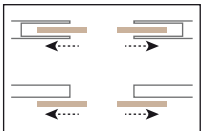

Simultaneous opening

The sliding solution that allows the creation of two coplanar doors with a synchronized and simultaneous opening, which even lets you only move one door. Both pocket door and wall mounted door solution.

• WOOD FIXING

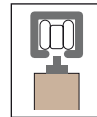

Standard double-entry bracket

An anchor bracket fixed in the upper part of the door leaf. The two way use allows both its front and lateral mounting.

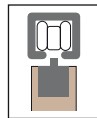

Bracket for minimal clearance installation

A bracket embedded into the panel to make the sliding door flush to the upper track.

• SOFT-CLOSE



Soft close device for soft opening and closing. Aluminum body, silent, integrated in the track and ultra-compact for installation also on narrow door leaf.

• MAGNETIC SOFT AND SELF CLOSING MECHANISM



Magnetic soft and self opening or closing mechanism, extremely silent, with a metal body integrated into the track. The compact form of the system allows to apply it on door leaves with a reduced width.



Magnetic soft and self opening and closing mechanism, extremely silent, with a metal body integrated into the track. The compact form of the system allows to apply it on door leaves with a reduced width.



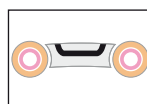



• SHOCK ABSORBER

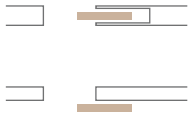

An element made of TPE (thermoplastic material) that allows the roller to absorb irregularities when sliding.

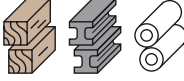
SYSTEM MAG·NUS



PAT-PENDING

<p>SLIDING Standard</p> 	<p>SMOOTH DOOR RELEASE</p> <p>Opening effort reduced by 50% compared to traditional systems</p>	<p>VERY QUIET</p>  <p>No hooking click sound</p>	<p>DOOR MATERIAL Wood, Metal and PVC</p> 	<p>SYSTEM LOAD CAPACITY from 20 kg to 80 kg</p> 	<p>ROLLERS Body: Zama Wheels: 4 Ball bearings: 4</p> 
<p>MAGNETIC SOFT AND SELF CLOSING MECHANISM</p> <p>ABS </p> <p>SINGLE / DOUBLE</p> <p>Type: Magnetic Covering: Steel</p>					



INDEX





A sliding set for Premium system MAGNUS

Set	Load capacity	Sliding	Soft-close	Page
MAGNUS ABS single	from 20 kg to 80 kg	Standard 	Opening or closing	14
MAGNUS ABS double	from 20 kg to 80 kg	Standard 	Opening and closing	15
Single ABS Magnus and Double ABS Magnus fixing set for the door and the lower track				16
Single ABS Magnus and Double ABS Magnus tracks and accessories				17
Single ABS Magnus and Double ABS Magnus spare parts				18

MAGNUS ABS SINGLE

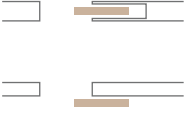
PAT-PENDING

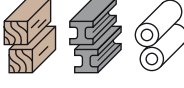
A magnetic soft closing system (single ABS) with a soft opening or closing and a soft door release. Capacity from 20 to 80 kg.

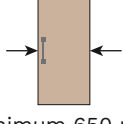
<p>SLIDING Standard</p> 	<p>SMOOTH DOOR RELEASE</p> <p>Opening effort reduced by 50% compared to traditional systems</p>	<p>VERY QUIET</p>  <p>No hooking click sound</p>	<p>DOOR MATERIAL Wood, Metal and PVC</p> 	<p>SYSTEM LOAD CAPACITY from 20 kg to 80 kg</p> 	<p>ROLLERS Body: Zamak Wheels: 4 Ball bearings: 4</p> 	<p>DOOR LEAF WIDTH</p>  <p>minimum 650 mm</p>
---	--	--	---	---	--	---

MAGNETIC SOFT AND SELF CLOSING MECHANISM

ABS SINGLE

Type: Magnetic
Covering: Steel



Kit components

1 door set

Item number: **0570 10 ABS**

Figure	Component	Quantity
1	Roller without magnet	1 piece
2	Roller with Magnetic soft close	1 piece
3	Soft close Activator - Magnus	1 piece
4	Braking activator - Magnus	1 piece
5	End-stop with adjustable unfasten force	1 piece
-	Valve seat wrench	1 piece

Complete the set in the section "Tracks, floor guide, Accessories and Spare parts".

Product details



Technical drawings

Dimensions indicated in millimeters



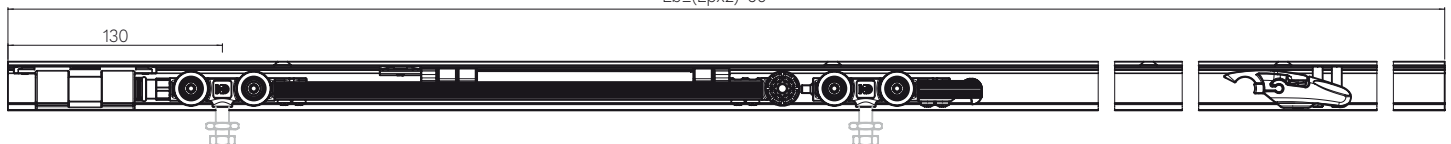

$L_b \geq (L_{px2}) - 60$



MAGNUS ABS DOUBLE

PAT-PENDING

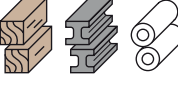
A magnetic soft closing system (double ABS) with a soft opening and closing and a soft door release. Capacity from 20 to 80 kg.

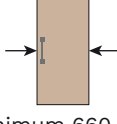
<p>SLIDING Standard</p> 	<p>SMOOTH DOOR RELEASE</p> <p>Opening effort reduced by 50% compared to traditional systems</p>	<p>VERY QUIET</p>  <p>No hooking click sound</p>	<p>DOOR MATERIAL Wood, Metal and PVC</p> 	<p>SYSTEM LOAD CAPACITY from 20 kg to 80 kg</p> 	<p>ROLLERS Body: Zamak Wheels: 4 Ball bearings: 4</p> 	<p>DOOR LEAF WIDTH</p>  <p>minimum 660 mm</p>
---	--	--	---	---	--	---

MAGNETIC SOFT AND SELF CLOSING MECHANISM

ABS DOUBLE

Type: Magnetic
Covering: Steel



Kit components

1 door set
Item number: **0570 20 ABS**

Figure	Component	Quantity
1	Roller with magnet	1 piece
2	Roller with Magnetic soft close	1 piece
3	Soft close Activator - Magnus	2 pieces
4	Braking activator - Magnus	2 pieces
-	Valve seat wrench	1 piece

Complete the set in the section "Tracks, floor guide, Accessories and Spare parts".

Product details



Technical drawings

Dimensions indicated in millimeters

$L_b \geq (L_p \times 2) - 60$

Single ABS Magnus and Double ABS Magnus fixing set for the door and the lower track

Traditional double entry fixing bracket and an adjustable floor guide



Kit components

1 door set

Item number: 0500 59

Figure	Component	Quantity
1	Double hooking door bracket	2 pieces
2	Adjustable floor guide	1 piece
3	Support screw for roller (hanger)	2 pieces
-	Fork wrench	1 piece

Technical drawings

Dimensions indicated in millimeters

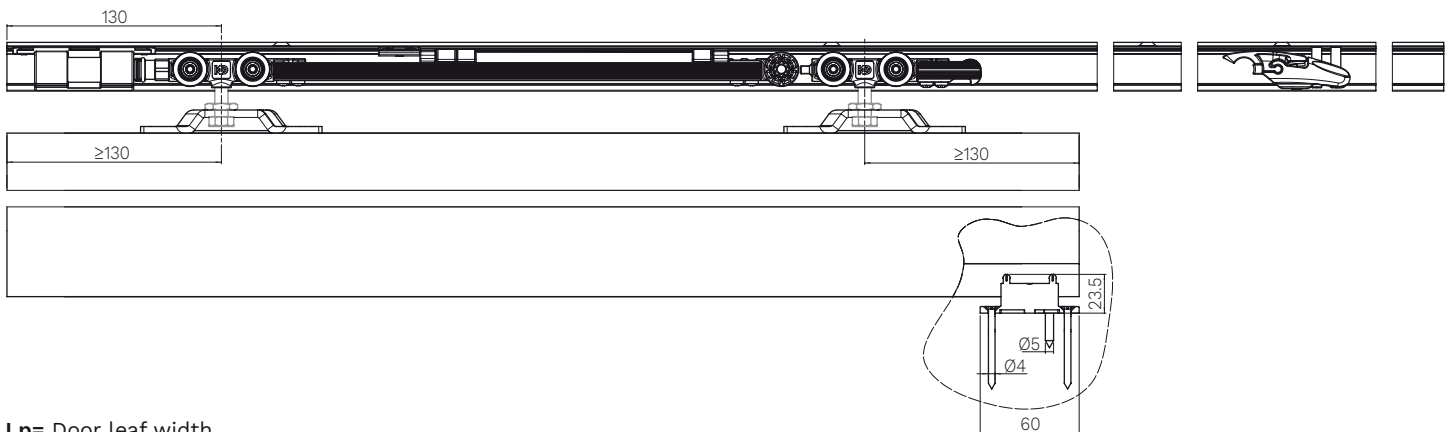

Lp= Door leaf width

Fixing bracket embedded in the door leaf and an adjustable floor guide

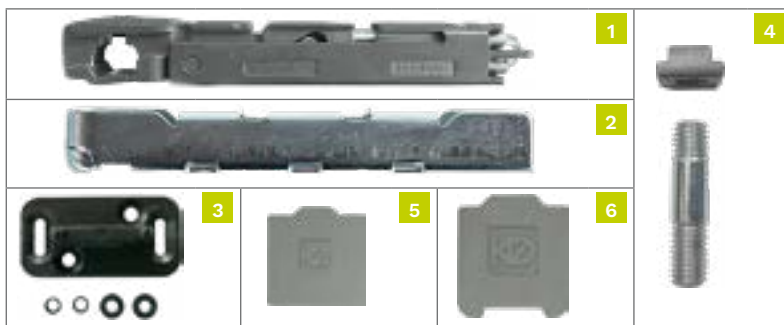

Kit components

1 door set

Item number: 0600 6 1

Figure	Component	Quantity
1	Door anchor bracket	2 pieces
2	Retainer profile	2 piece
3	Adjustable floor guide	1 piece
4	Support screw for roller (hanger)	2 pieces
5	In line closing cap	2 pieces
6	Closing cap	2 pieces
-	Fork wrench	1 piece

Technical drawings

Dimensions indicated in millimeters

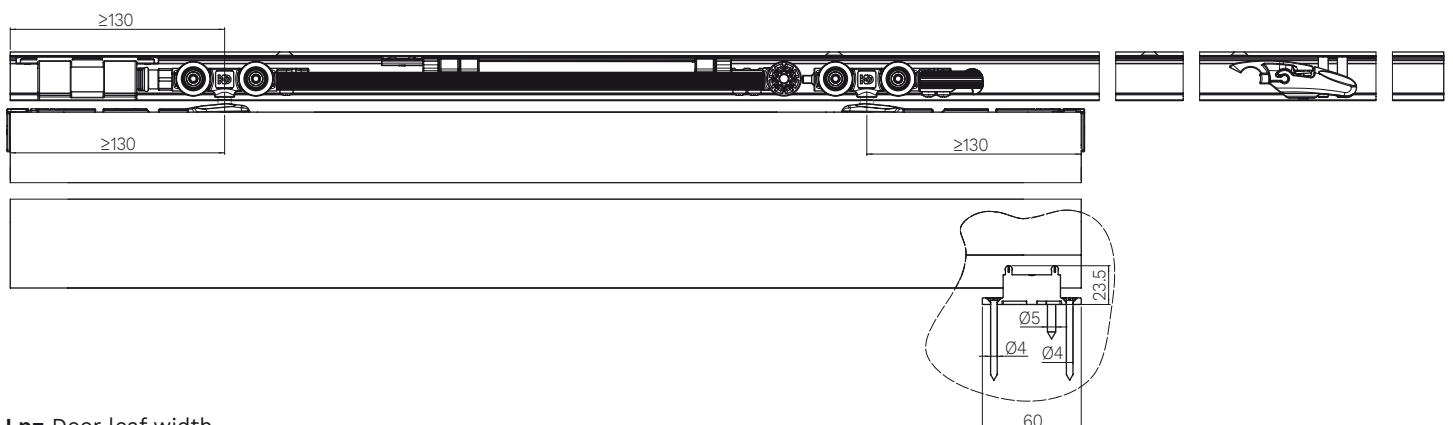

Lp= Door leaf width

Single ABS Magnus and Double ABS Magnus tracks and accessories

Complete the kit with track and accessory according to application.

Installation examples with a traditional double entry bracket

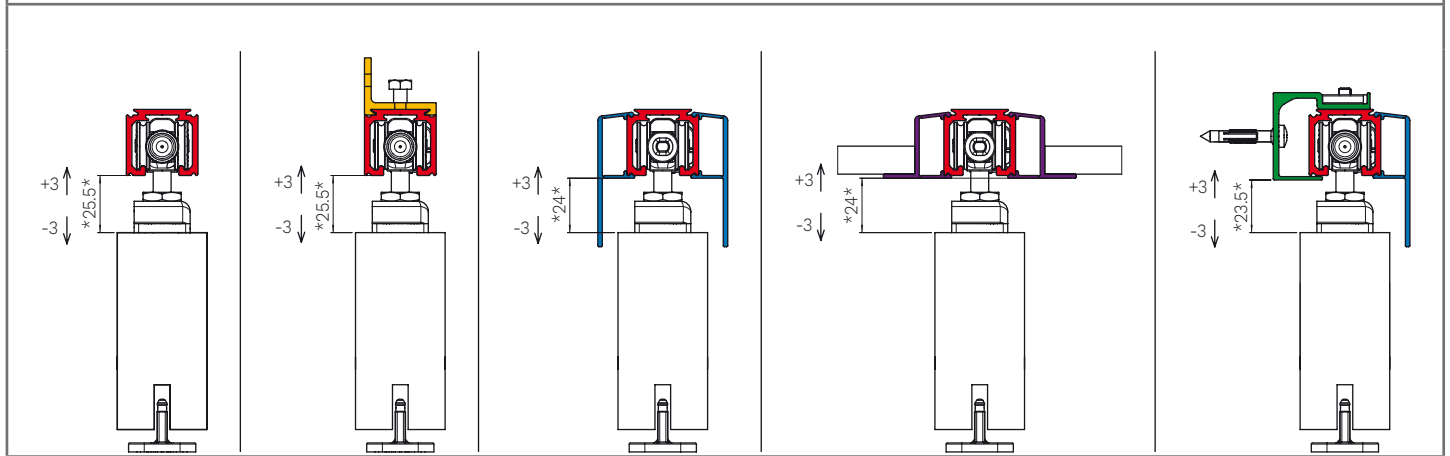

Installation examples with an embedded bracket

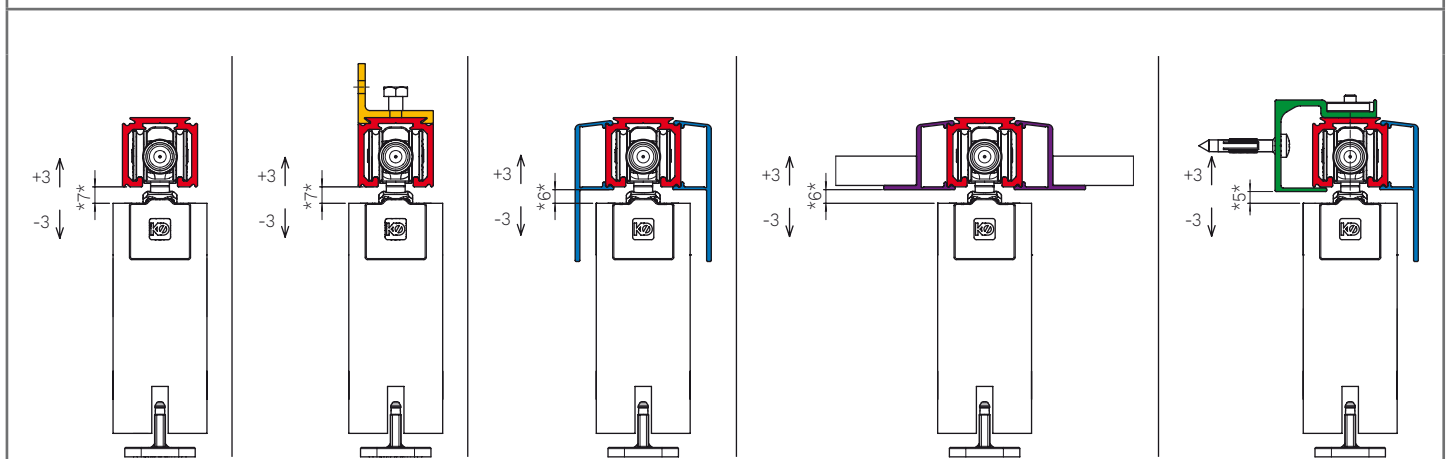

Dimensions tracks and accessories

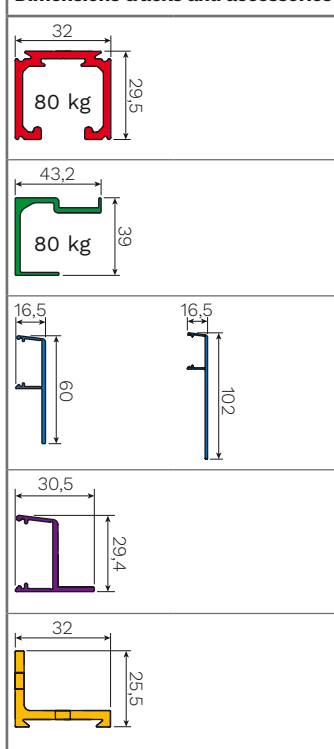

Tracks

Drilled and anodised aluminium track - 80 kg	Item number.
1,8 meters	0500 180
2 meters	0500 200
2,4 meters	0500 240
3 meters	0500 300
4 meters	0500 400
6 meters	0500 1

Accessories

Component	Item number.
Pelmet high cover - 2 meters	0500 A 200
Pelmet high cover - 3 meters	0500 A 300
Pelmet high cover - 4 meters	0500 A 400
Pelmet medium cover - 2 meters	0500 M 200
Pelmet medium cover - 3 meters	0500 M 300
Pelmet medium cover - 4 meters	0500 M 400
False ceiling profile - 2 meters	0500 C 200
False ceiling profile - 3 meters	0500 C 300
False ceiling profile - 4 meters	0500 C 400
Wall fixing - 80 Kg - 2 meters	0500 F 200
Wall fixing - 80 Kg - 3 meters	0500 F 300
Wall fixing - 80 Kg - 4 meters	0500 F 400
L shape wall fixing - 80 kg	0500 4
Track end cap	0500 61
Pelmet medium end cap	0500 63
Pelmet high end cap	0500 64





Single ABS Magnus and Double ABS Magnus spare parts

Spare parts			
Component	*Quantity	Item number.	Which set is it for?
Roller with Magnetic soft close	1 piece	0570 ABS	<i>MAGNUS ABS single / MAGNUS ABS double</i>
Braking activator	1 piece		
Roller without magnet	1 piece	0570 1 ABS	<i>MAGNUS ABS single</i>
End-stop with adjustable unfasten force	1 piece		
Roller with magnet	1 piece	0570 2 ABS	<i>MAGNUS ABS double</i>
Soft close Activator	1 piece		
Braking activator	1 piece		
Soft close Activator	1 piece	0570 ABS 3	<i>MAGNUS ABS single / MAGNUS ABS double</i>
Braking activator	1 piece		
End-stop with adjustable unfasten force	1 piece		

*The minimum order quantity is indicated.

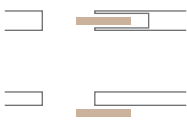
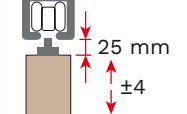
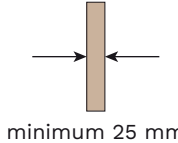
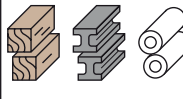
SYSTEM PREMIUM 0500

PATENTED

<p>SLIDING Standard</p> 	<p>FIXING Standard double-entry bracket</p> 	<p>DOOR THICKNESS</p>  <p>minimum 25 mm</p>	<p>DOOR MATERIAL Wood, Metal and PVC</p> 	<p>SYSTEM LOAD CAPACITY Up to 120 kg</p> 	<p>ROLLERS Body: Zamak Wheels: 2 or 4 Ball bearings: 2 or 4</p> 	<p>ANTI-VIBRATION SYSTEM</p> 
<p>SOFT-CLOSE</p> <p>ABS </p> <p>DOUBLE</p> <p>Type: Mechanic Covering: Steel</p>						



Index

Terms

Slider
Wood Premium

Slider
Glass Premium

Basic
Slider

Outdoor
Slider

Design
Slider

Optional











Folding
solutions

Swinging
solutions

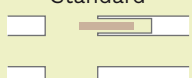

INDEX





A sliding set for Premium system 0500

Set	Load capacity	Door thickness	Sliding	Soft-close	Page
0500 2	60 kg	minimum 25 mm	Standard 	No	22
0500 60 ABS	60 kg	minimum 25 mm	Standard 	Yes	23
Tracks, Accessories and Spare parts 0500 2 / 0500 60 ABS					24
0500 3	120 kg	minimum 25 mm	Standard 	No	25
0500 120 ABS	120 kg	minimum 25 mm	Standard 	Yes	26
Tracks, Accessories and Spare parts 0500 3 / 0500 120 ABS					27
Set with a 2m track and a beam					
0500 20	60 kg	minimum 25 mm	Standard 	No	28
0500 60 20 ABS	60 kg	minimum 25 mm	Standard 	Yes	29
0500 30	80 kg	minimum 25 mm	Standard 	No	30
Tracks, Accessories and Spare parts 0500 20 / 0500 60 20 ABS / 0500 30					31
Set with a 2m track, a beam and a pelmet					
0500 21	60 kg	minimum 25 mm	Standard 	No	32
0500 60 21 ABS	60 kg	minimum 25 mm	Standard 	Yes	33
0500 31	80 kg	minimum 25 mm	Standard 	No	34
Tracks, Accessories and Spare parts 0500 21 / 0500 60 21 ABS / 0500 31					35

Optional			
System	Description	Item number.	Page
New Kit Klose	Self closing - outside the wall	0880 1	149
	Self closing - inside the wall	0880 2	150
2000	Parallel door sliding gear	2000	152

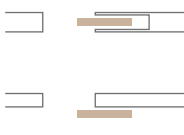
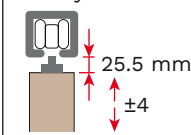
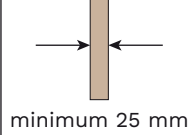
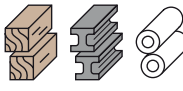
KIT 0500 2 PATENTED

Standard sliding door kit. Zamak roller, double-entry bracket, end-stop with adjustable unfasten force. Load capacity 60 kg.

SLIDING Standard 	FIXING Standard double-entry bracket 	DOOR THICKNESS 	DOOR MATERIAL Wood, Metal and PVC 	SYSTEM LOAD CAPACITY Up to 60 kg 	ROLLERS Body: Zamak Wheels: 2 Ball bearings: 2 	ANTI-VIBRATION SYSTEM 
--	---	--	--	--	---	---

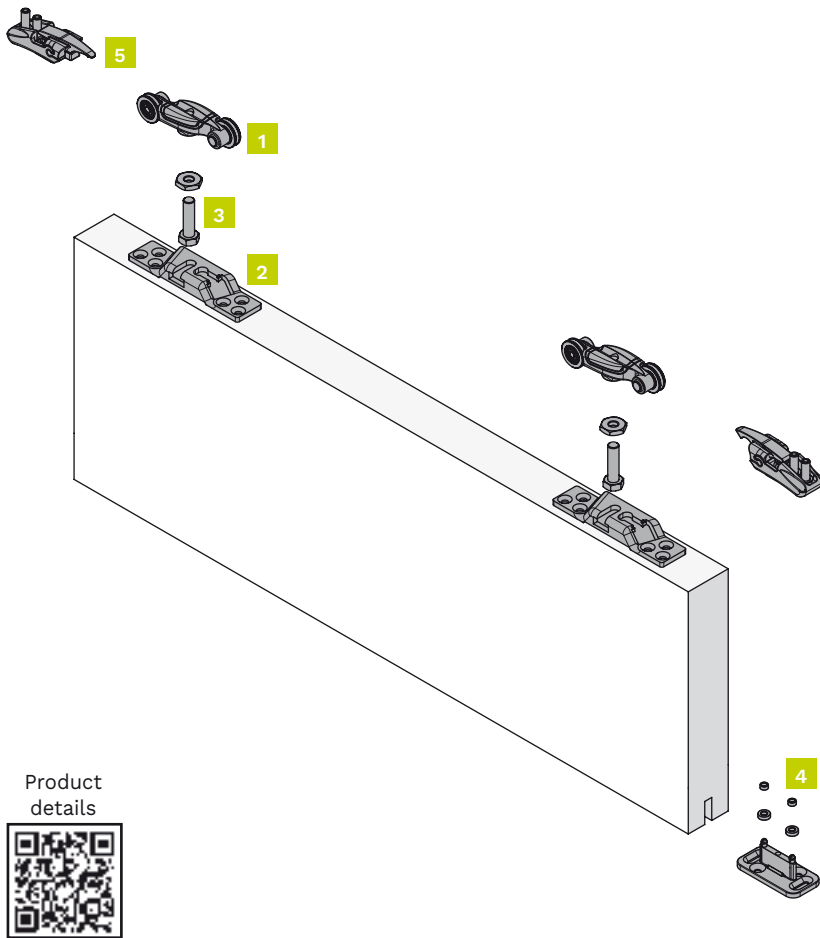

Kit components

1 door set
Item number: 0500 2

Figure	Component	Quantity
1	Upper roller - 60 kg	2 pieces
2	Double hooking door bracket	2 pieces
3	Support screw for roller (hanger)	2 pieces
4	Adjustable lower guide	1 piece
5	End-stop with adjustable unfasten force	2 pieces
-	Valve seat wrench	1 piece
-	Fork wrench	1 piece

Complete the set in the section "Tracks, Accessories and Spare parts".



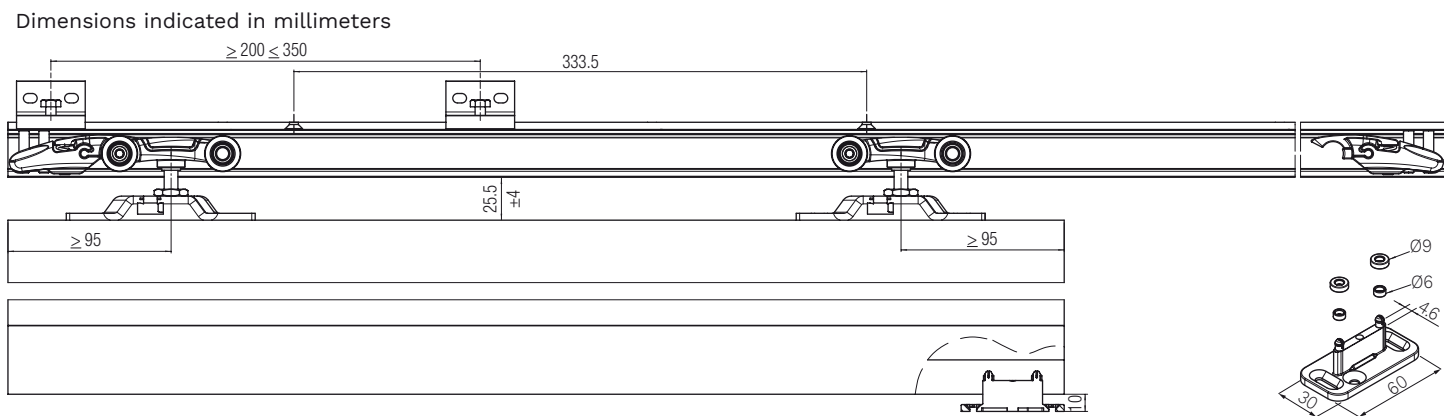

Technical drawings

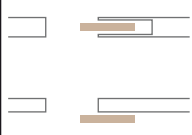
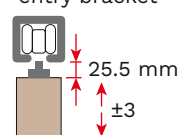
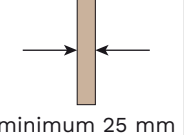
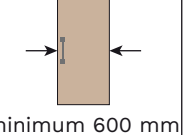
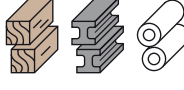

KIT 0500 60 ABS

PATENTED

Standard sliding door kit. Zamak roller, double-entry bracket, double ABS soft closing. Load capacity 60 kg.

SLIDING Standard 	FIXING Standard double-entry bracket  25.5 mm ± 3	DOOR THICKNESS  minimum 25 mm	DOOR LEAF WIDTH  minimum 600 mm	DOOR MATERIAL Wood, Metal and PVC 	SYSTEM LOAD CAPACITY Up to 60 kg 	ROLLERS Body: Zamak Wheels: 2 Ball bearings: 2 
ANTI-VIBRATION SYSTEM 	SOFT-CLOSE ABS DOUBLE Type: Mechanic Covering: Steel					

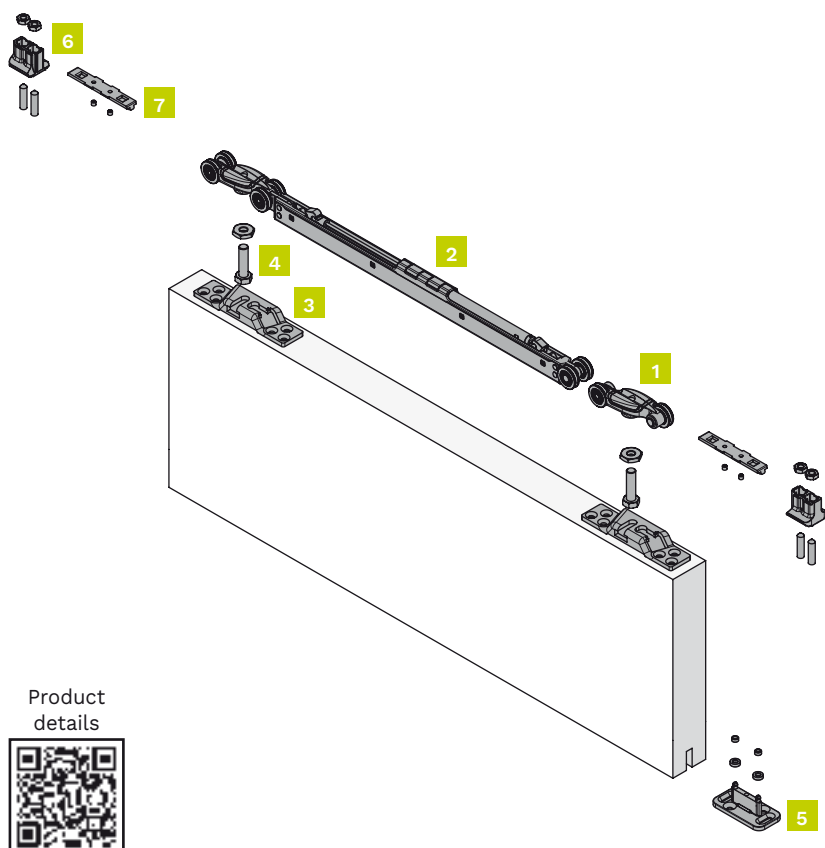

Kit components

1 door set
Item number: 0500 60 ABS

Figure	Component	Quantity
1	Upper roller - 60 kg	1 piece
2	Roller with soft close device (double ABS) - 60 kg	1 piece
3	Double hooking door bracket	2 pieces
4	Support screw for roller (hanger)	2 pieces
5	Adjustable lower guide	1 piece
6	Double ABS door stop	2 pieces
7	Double ABS activator	2 pieces
-	Valve seat wrench	1 piece
-	Fork wrench	1 piece

Complete the set in the section "Tracks, Accessories and Spare parts".

Product details



Technical drawings

Dimensions indicated in millimeters

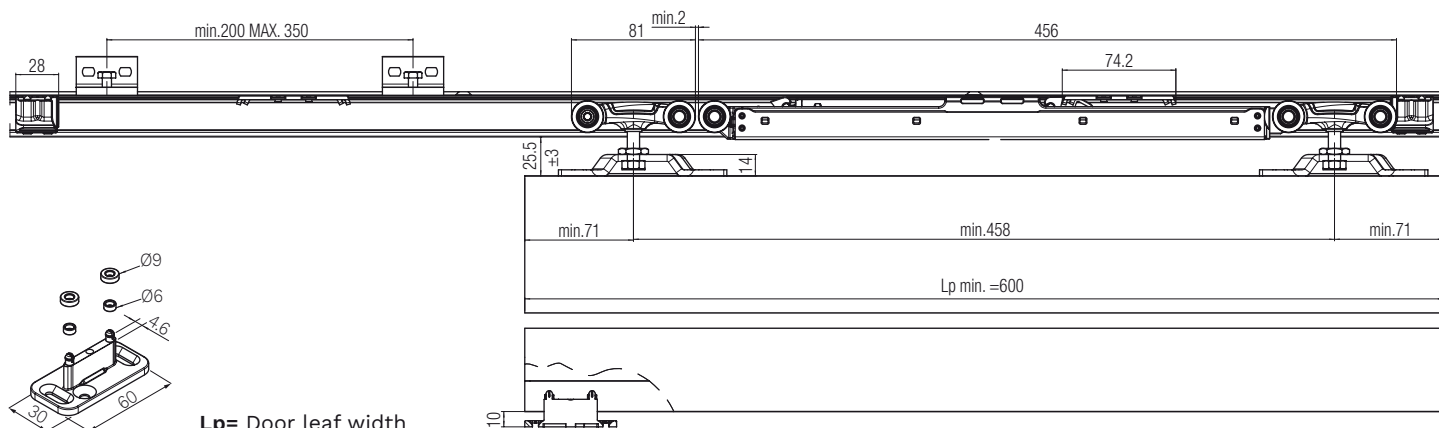

Tracks, Accessories and Spare parts 0500 2 / 0500 60 ABS

Complete the kit with track and accessory according to application.

Installation examples

Dimensions indicated in millimeters and are related to a 80 kg track. You can find the complete dimensions in the mounting instructions.

Dimensions tracks and accessories

Tracks	
Drilled and anodised aluminium track - 80 kg	Item number.
1,8 meters	0500 180
2 meters	0500 200
2,4 meters	0500 240
3 meters	0500 300
4 meters	0500 400
6 meters	0500 1
Drilled and anodised aluminium track - 120 kg	Item number.
3 meters	0500 10 300
6 meters	0500 10







Accessories	
Component	Item number.
Pelmet high cover - 2 meters	0500 A 200
Pelmet high cover - 3 meters	0500 A 300
Pelmet high cover - 4 meters	0500 A 400
Pelmet medium cover - 2 meters	0500 M 200
Pelmet medium cover - 3 meters	0500 M 300
Pelmet medium cover - 4 meters	0500 M 400
Wall fixing - 80 Kg - 2 meters	0500 F 200
Wall fixing - 80 Kg - 3 meters	0500 F 300
Wall fixing - 80 Kg - 4 meters	0500 F 400
Wall fixing - 120 Kg - 3 meters	0500 F 10 300
L shape wall fixing - 80 kg	0500 4
L shape wall fixing - 120 kg	0500 5
Track end cap	0500 61
Pelmet medium end cap	0500 63
Pelmet high end cap	0500 64

Spare parts			
Component	*Quantity	Item number.	Which set is it for?
Upper roller - 60 kg	2 pieces	0500 51	0500 2 / 0500 60 ABS
Roller with soft close device (double ABS) - 60 kg	1 piece	0500 60 12 ABS	0500 60 ABS
Double ABS door stop	2 pieces		
Double ABS activator	2 pieces		
Double ABS activator	1 piece	0500 12 60 ABS	0500 60 ABS
Double hooking door bracket	2 pieces	0500 55	0500 2 / 0500 60 ABS
Support screw for roller (hanger)	2 pieces	0500 54	0500 2 / 0500 60 ABS
Adjustable lower guide	20 pieces	0500 13	0500 2 / 0500 60 ABS
End-stop with adjustable unfasten force	2 pieces	0500 12	0500 2
Fixing plates + screws for hooking profile to a wall	100 pieces	0500 58	0500 2 / 0500 60 ABS

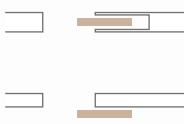
*The minimum order quantity is indicated.

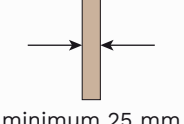
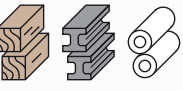
KIT 0500 3 PATENTED

Standard sliding door kit. Zamak roller, double-entry bracket, end-stop with adjustable unfasten force. Load capacity 120 kg.

SLIDING Standard 	FIXING Standard double-entry bracket 	DOOR THICKNESS 	DOOR MATERIAL Wood, Metal and PVC 	SYSTEM LOAD CAPACITY Up to 120 kg 	ROLLERS Body: Zamak Wheels: 4 Ball bearings: 4 	ANTI-VIBRATION SYSTEM 
--	---	--	--	---	---	---

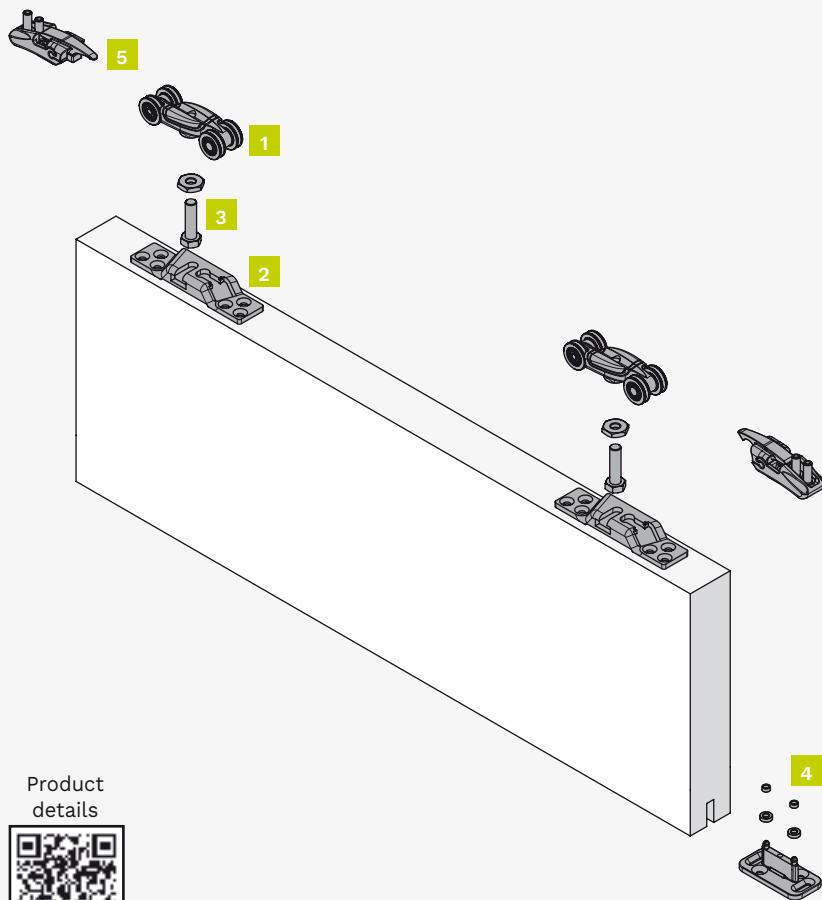

Kit components

1 door set
Item number: 0500 3

Figure	Component	Quantity
1	Upper roller - 120 kg	2 pieces
2	Double hooking door bracket	2 pieces
3	Support screw for roller (hanger)	2 pieces
4	Adjustable lower guide	1 piece
5	End-stop with adjustable unfasten force	2 pieces
-	Valve seat wrench	1 piece
-	Fork wrench	1 piece

Complete the set in the section "Tracks, Accessories and Spare parts".

Product details



Technical drawings



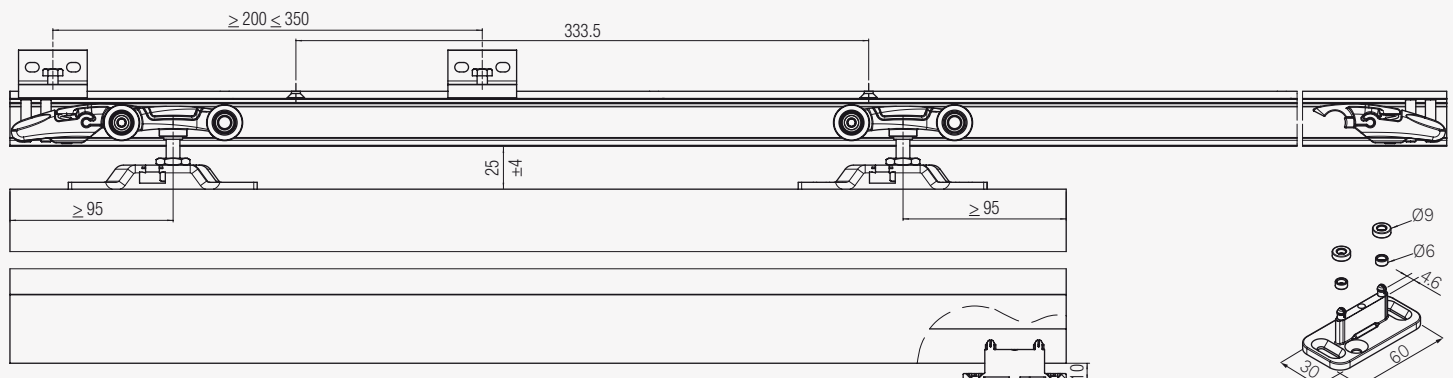

Dimensions indicated in millimeters

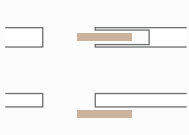
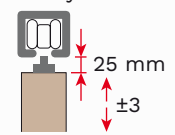
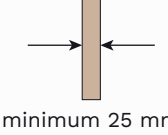
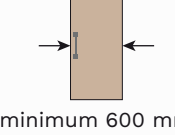
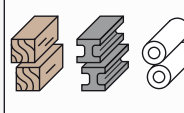

KIT 0500 120 ABS

PATENTED

Standard sliding door kit. Zamak roller, double-entry bracket, double ABS soft closing. Load capacity 120 kg.

<p>SLIDING Standard</p> 	<p>FIXING Standard double-entry bracket</p> 	<p>DOOR THICKNESS</p> 	<p>DOOR LEAF WIDTH</p> 	<p>DOOR MATERIAL Wood, Metal and PVC</p> 	<p>SYSTEM LOAD CAPACITY Up to 120 kg</p> 	<p>ROLLERS Body: Zamak Wheels: 4 Ball bearings: 4</p> 
<p>ANTI-VIBRATION SYSTEM</p> 		<p>SOFT-CLOSE</p> <p>ABS DOUBLE</p> <p>Type: Mechanic Covering: Steel</p>				

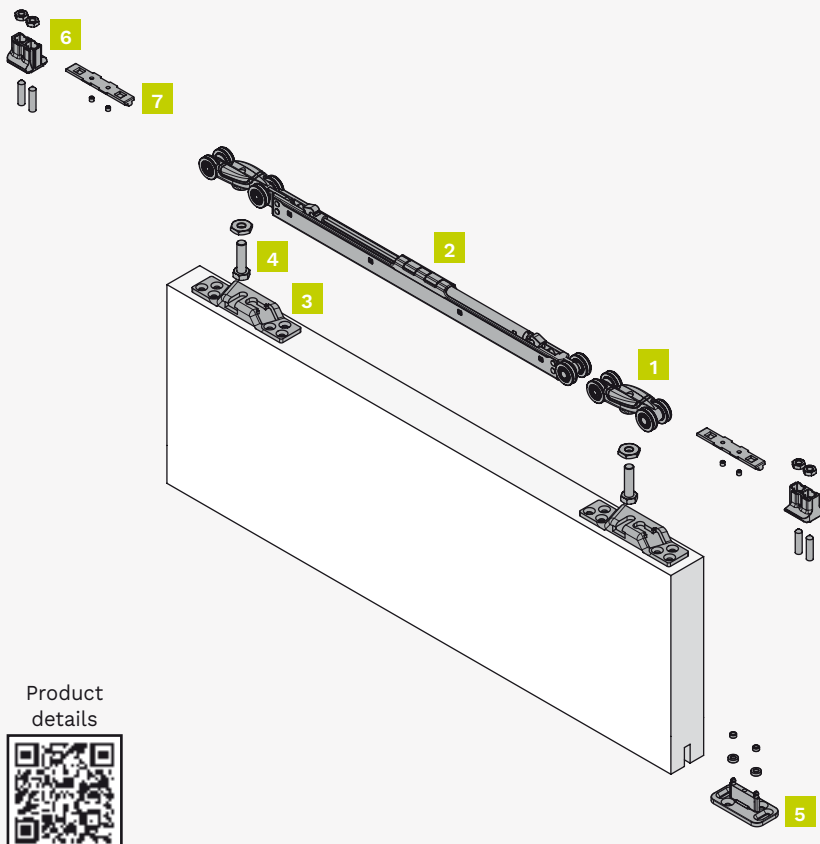

Kit components

1 door set

Item number: 0500 120 ABS

Figure	Component	Quantity
1	Upper roller - 120 kg	1 piece
2	Roller with soft close device (double ABS) - 120 kg	1 piece
3	Double hooking door bracket	2 pieces
4	Support screw for roller (hanger)	2 pieces
5	Adjustable lower guide	1 piece
6	Double ABS door stop	2 pieces
7	Double ABS activator	2 pieces
-	Valve seat wrench	1 piece
-	Fork wrench	1 piece

Complete the set in the section "Tracks, Accessories and Spare parts".

Product details



Technical drawings

Dimensions indicated in millimeters

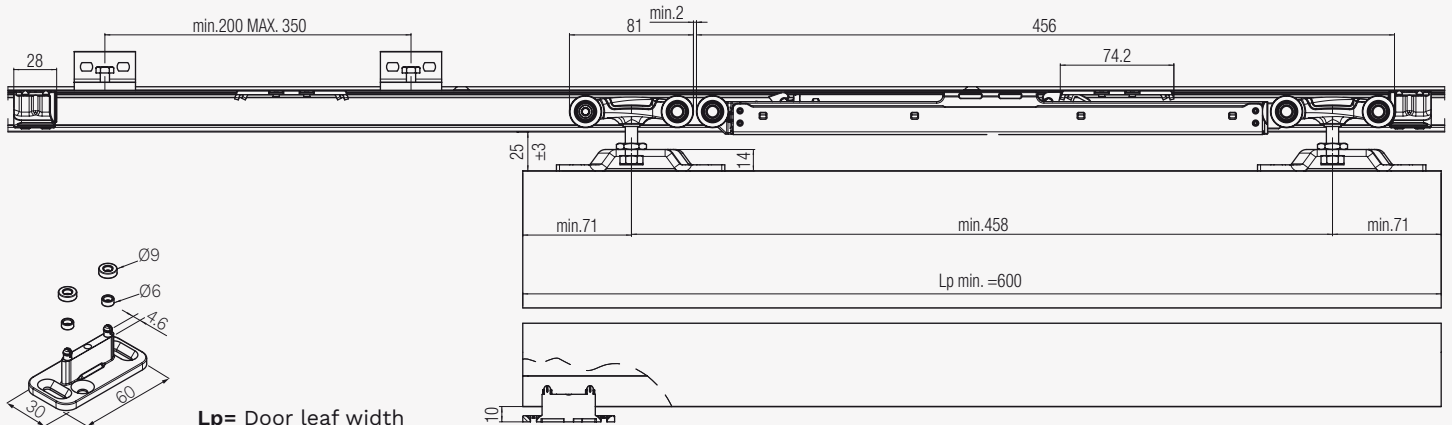

Lp= Door leaf width

Tracks, Accessories and Spare parts 0500 3 / 0500 120 ABS

Complete the kit with track and accessory according to application.

Installation examples

Dimensions indicated in millimeters and are related to a 120 kg track. You can find the complete dimensions in the mounting instructions.

Dimensions tracks and accessories

Tracks	
Drilled and anodised aluminium track - 120 kg	Item number.
3 meters	0500 10 300
6 meters	0500 10
Drilled and anodised aluminium track - 80 kg (for max. 80 kg door leaf only)	Item number.
1,8 meters	0500 180
2 meters	0500 200
2,4 meters	0500 240
3 meters	0500 300
4 meters	0500 400
6 meters	0500 1





Accessories	
Component	Item number.
Pelmet high cover - 2 meters	0500 A 200
Pelmet high cover - 3 meters	0500 A 300
Pelmet high cover - 4 meters	0500 A 400
Pelmet medium cover - 2 meters	0500 M 200
Pelmet medium cover - 3 meters	0500 M 300
Pelmet medium cover - 4 meters	0500 M 400
Wall fixing - 80 Kg - 2 meters	0500 F 200
Wall fixing - 80 Kg - 3 meters	0500 F 300
Wall fixing - 80 Kg - 4 meters	0500 F 400
Wall fixing - 120 Kg - 3 meters	0500 F 10 300
L shape wall fixing - 80 kg	0500 4
L shape wall fixing - 120 kg	0500 5
Track end cap	0500 61
Pelmet medium end cap	0500 63
Pelmet high end cap	0500 64

Spare parts			
Component	*Quantity	Item number.	Which set is it for?
Upper roller - 120 kg	2 pieces	0500 52	0500 3 / 0500 120 ABS
Roller with soft close device (double ABS) - 120 kg	1 piece	0500 120 12 ABS	0500 120 ABS
Double ABS door stop	2 pieces		
Double ABS activator	2 pieces	0500 12 60 ABS	0500 120 ABS
Double ABS activator	1 piece		
Double hooking door bracket	2 pieces	0500 55	0500 3 / 0500 120 ABS
Support screw for roller (hanger)	2 pieces	0500 54	0500 3 / 0500 120 ABS
Adjustable lower guide	20 pieces	0500 13	0500 3 / 0500 120 ABS
End-stop with adjustable unfasten force	2 pieces	0500 12	0500 3
Fixing plates + screws for hooking profile to a wall	100 pieces	0500 58	0500 3 / 0500 120 ABS

*The minimum order quantity is indicated.

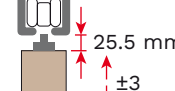
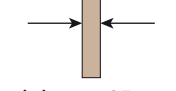
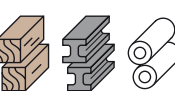
KIT 0500 20 PATENTED

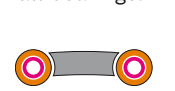
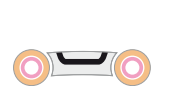
Standard sliding door kit with a track and a beam. Zamak roller, double-entry bracket, end-stop with adjustable unfasten force. Load capacity 60 kg.

<p>SLIDING Standard</p> 	<p>FIXING Standard double-entry bracket</p> 	<p>DOOR THICKNESS</p> 	<p>DOOR MATERIAL Wood, Metal and PVC</p> 	<p>SYSTEM LOAD CAPACITY Up to 60 kg</p> 	<p>ROLLERS Body: Zamak Wheels: 2 Ball bearings: 2</p> 	<p>ANTI-VIBRATION SYSTEM</p> 
<p>INCLUDED IN THE KIT Beam and track</p>  <p>2000 mm</p>		 <p>PEFC PEFC/18-31-602</p>				

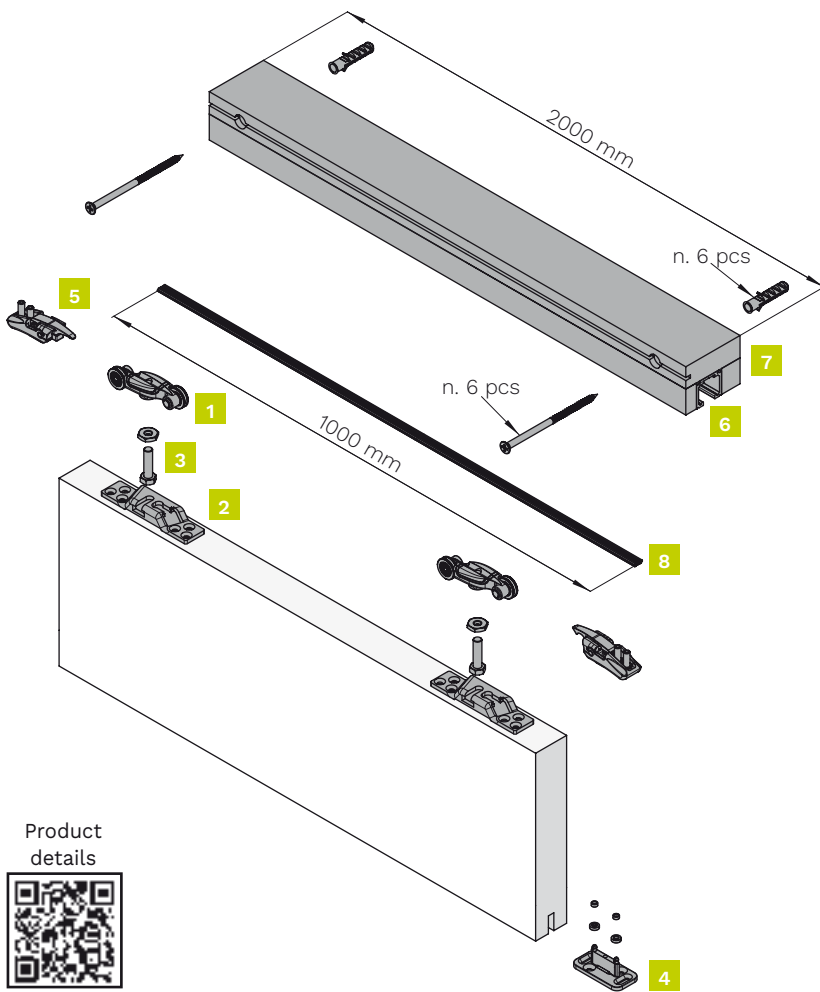

Kit components

1 door set
Item number: 0500 20

Figure	Component	Quantity
1	Upper roller - 60 kg	2 pieces
2	Double hooking door bracket	2 pieces
3	Support screw for roller (hanger)	2 pieces
4	Adjustable lower guide	1 piece
5	End-stop with adjustable unfasten force	2 pieces
6	Pre-drilled and black anodised alu. track - 80 kg - 2 meters	1 piece
7	Pre-drilled multilayer wooden beam, black laminated - 80 kg - 2 meters	1 piece
8	Plastic profile for pelmet fixing - 1 meter	1 piece





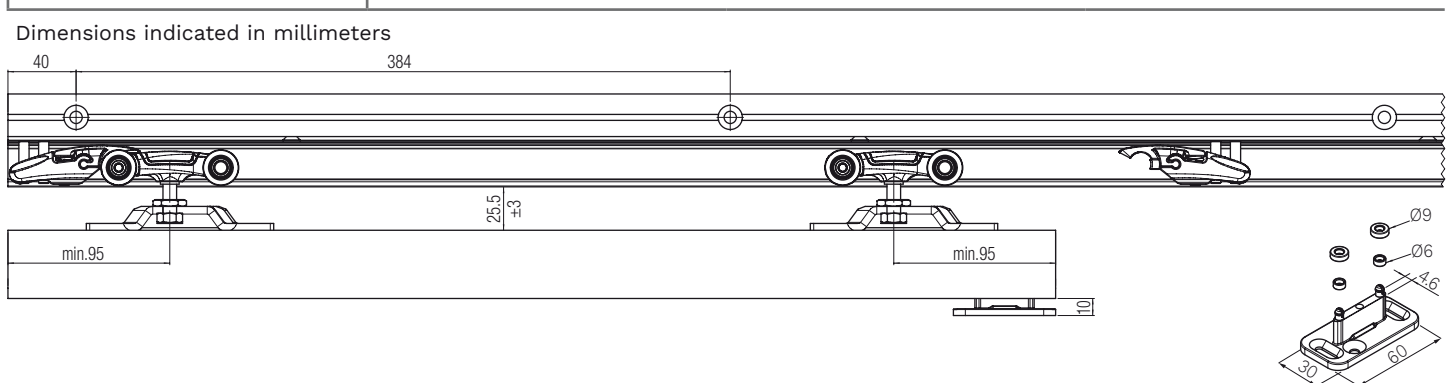



Technical drawings

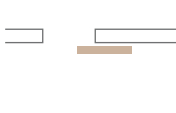
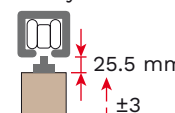
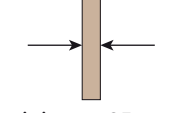
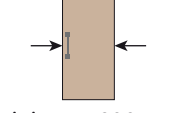
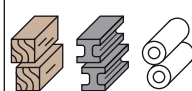

KIT 0500 60 20 ABS

PATENTED

Standard sliding door kit with a track and a beam. Zamak roller, double-entry bracket, double ABS soft closing. Load capacity 60 kg.

SLIDING Standard 	FIXING Standard double-entry bracket 	DOOR THICKNESS 	DOOR LEAF WIDTH 	DOOR MATERIAL Wood, Metal and PVC 	SYSTEM LOAD CAPACITY Up to 60 kg 	ROLLERS Body: Zamak Wheels: 2 Ball bearings: 2 
ANTI-VIBRATION SYSTEM 	SOFT-CLOSE ABS DOUBLE Type: Mechanic Covering: Steel 		INCLUDED IN THE KIT Beam and track  2000 mm	 PEFC/18-31-602		

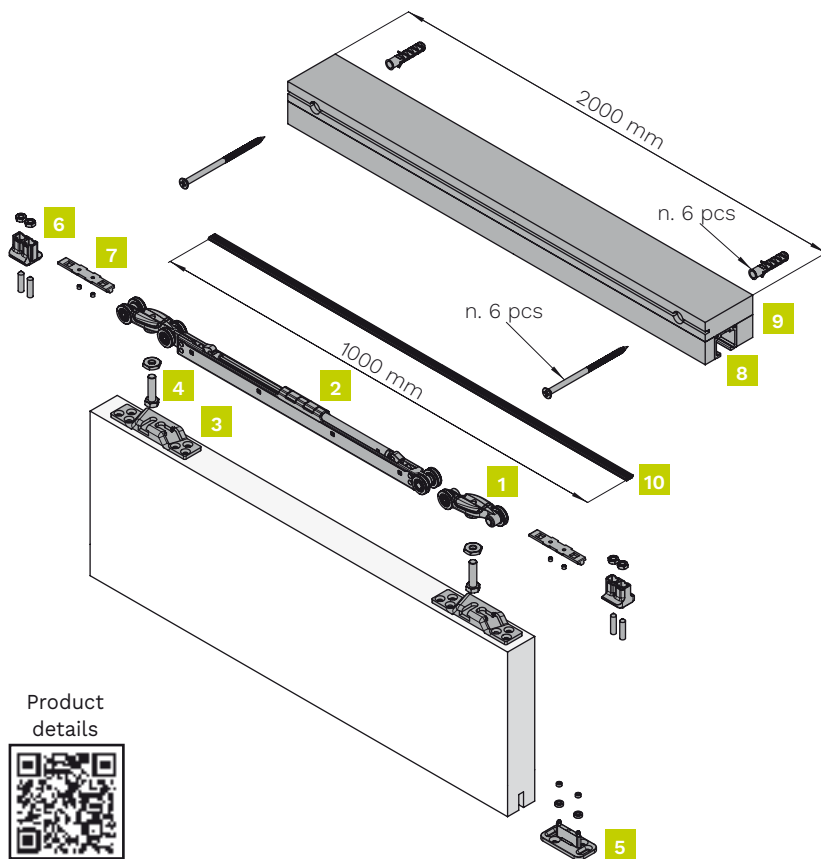

Kit components

1 door set
Item number: 0500 60 20 ABS

Figure	Component	Quantity
1	Upper roller - 60 kg	1 piece
2	Roller with soft close device (double ABS) - 60 kg	1 piece
3	Double hooking door bracket	2 pieces
4	Support screw for roller (hanger)	2 pieces
5	Adjustable lower guide	1 piece
6	Double ABS door stop	2 pieces
7	Double ABS activator	2 pieces
8	Pre-drilled and black anodised alu. track - 80 kg - 2 meters	1 piece
9	Pre-drilled multilayer wooden beam, black laminated - 80 kg - 2 meters	1 piece
10	Plastic profile for pelmet fixing - 1 meter	1 piece

Product details



Technical drawings



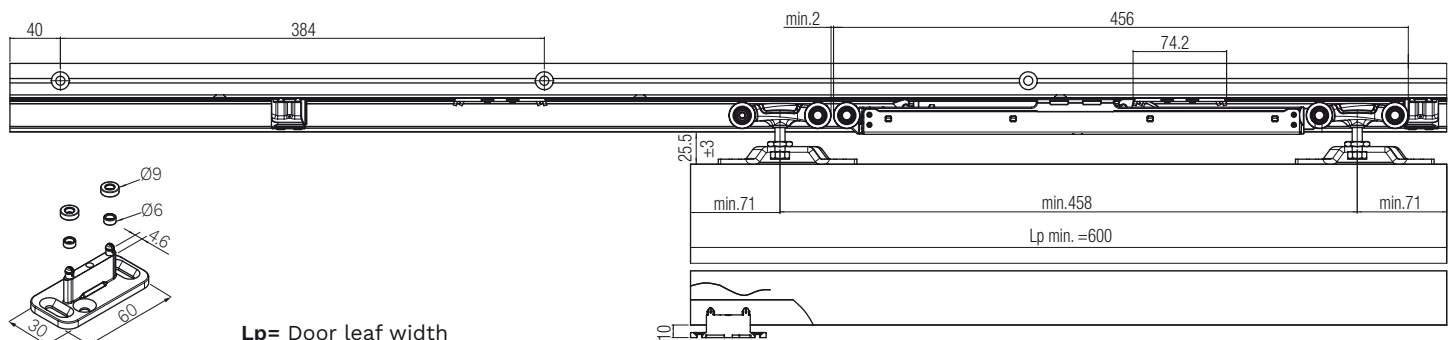

Dimensions indicated in millimeters

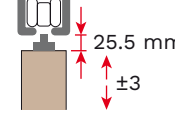
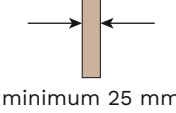
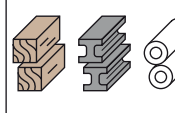

Lp= Door leaf width

KIT 0500 30 PATENTED

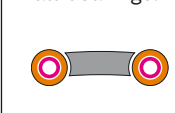
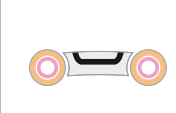
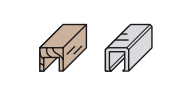
Standard sliding door kit with a track and a beam. Zamak roller, double-entry bracket, end-stop with adjustable unfasten force. Load capacity 80 kg.

SLIDING Standard 	FIXING Standard double-entry bracket  25.5 mm ± 3	DOOR THICKNESS  minimum 25 mm	DOOR MATERIAL Wood, Metal and PVC 	SYSTEM LOAD CAPACITY Up to 80 kg 	ROLLERS Body: Zamak Wheels: 4 Ball bearings: 4 	ANTI-VIBRATION SYSTEM 
INCLUDED IN THE KIT Beam and track  2000 mm	 PEFC PEFC/18-31-602					

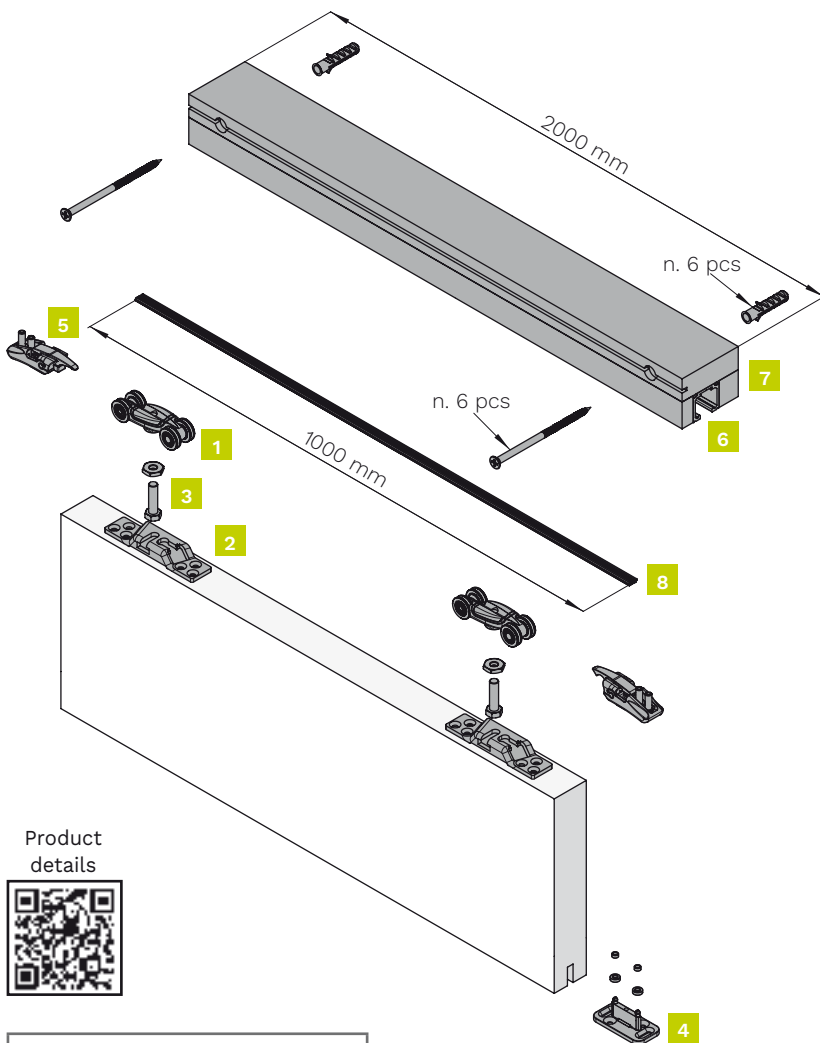

Kit components		
1 door set		
Item number: 0500 30		
Figure	Component	Quantity
1	Upper roller - 120 kg	2 pieces
2	Double hooking door bracket	2 pieces
3	Support screw for roller (hanger)	2 pieces
4	Adjustable lower guide	1 piece
5	End-stop with adjustable unfasten force	2 pieces
6	Pre-drilled and black anodised alu. track - 80 kg - 2 meters	1 piece
7	Pre-drilled multilayer wooden beam, black laminated - 80 kg - 2 meters	1 piece
8	Plastic profile for pelmet fixing - 1 meter	1 piece

Product details



Technical drawings

Dimensions indicated in millimeters

Tracks, Accessories and Spare parts 0500 20 / 0500 60 20 ABS / 0500 30

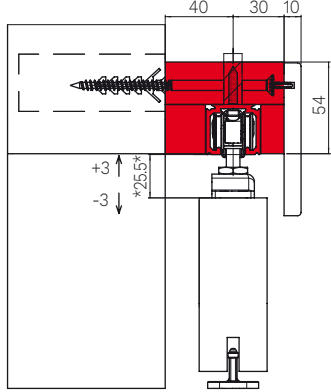
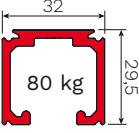





Installation examples	Dimensions tracks and accessories
<p>Dimensions indicated in millimeters</p> 	

Spare parts			
Component	*Quantity	Item number.	Which set is it for?
Upper roller - 60 kg	2 pieces	0500 51	0500 20 / 0500 60 20 ABS
Upper roller - 120 kg	2 pieces	0500 52	0500 30
Roller with soft close device (double ABS) - 60 kg	1 piece	0500 60 12 ABS	0500 60 20 ABS
Double ABS door stop	2 pieces		
Double ABS activator	2 pieces		
Double ABS activator	1 piece	0500 12 60 ABS	0500 60 20 ABS
Double hooking door bracket	2 pieces	0500 55	0500 20 / 0500 60 20 ABS / 0500 30
Support screw for roller (hanger)	2 pieces	0500 54	0500 20 / 0500 60 20 ABS / 0500 30
Adjustable lower guide	20 pieces	0500 13	0500 20 / 0500 60 20 ABS / 0500 30
End-stop with adjustable unfasten force	2 pieces	0500 12	0500 20 / 0500 30
Plastic profile for pelmet fixing - 1 meter	1 piece	0500 8	0500 20 / 0500 60 20 ABS / 0500 30
Pre-drilled and black anodised alu. track - 80 kg - 2 meters	1 piece	0500 200 N	0500 20 / 0500 60 20 ABS / 0500 30

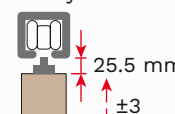
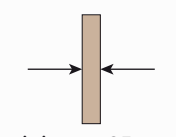
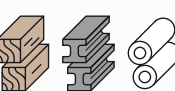
*The minimum order quantity is indicated.

KIT 0500 21 PATENTED

Standard sliding door kit with a track, a beam and a pelmet. Zamak roller, double-entry bracket, end-stop with adjustable unfasten force. Load capacity 60 kg.

<p>SLIDING Standard</p> 	<p>FIXING Standard double-entry bracket</p> 	<p>DOOR THICKNESS</p> 	<p>DOOR MATERIAL Wood, Metal and PVC</p> 	<p>SYSTEM LOAD CAPACITY Up to 60 kg</p> 	<p>ROLLERS Body: Zamak Wheels: 2 Ball bearings: 2</p> 	<p>ANTI-VIBRATION SYSTEM</p> 
<p>INCLUDED IN THE KIT Beam, track and pelmet</p>  <p>2000 mm</p>						

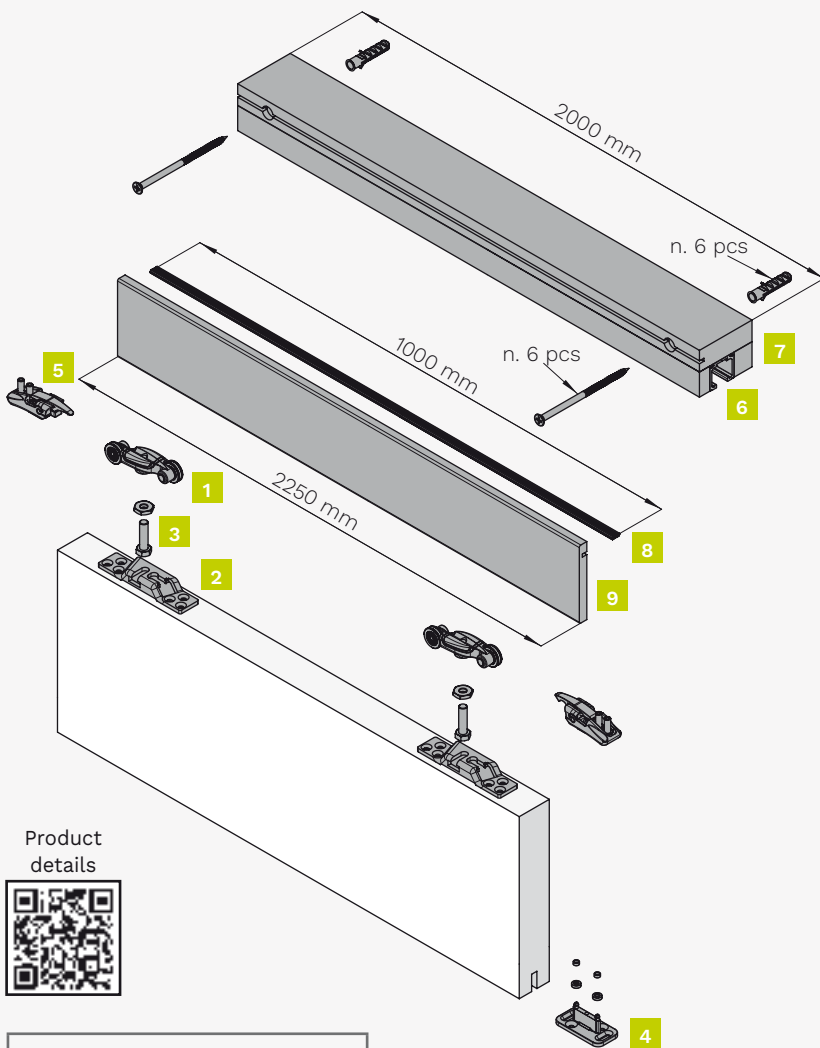

Kit components

1 door set
Item number: 0500 21

Figure	Component	Quantity
1	Upper roller - 60 kg	2 pieces
2	Double hooking door bracket	2 pieces
3	Support screw for roller (hanger)	2 pieces
4	Adjustable lower guide	1 piece
5	End-stop with adjustable unfasten force	2 pieces
6	Pre-drilled and black anodised alu. track - 80 kg - 2 meters	1 piece
7	Pre-drilled multilayer wooden beam, black laminated - 80 kg - 2 meters	1 piece
8	Plastic profile for pelmet fixing - 1 meter	1 piece
9	Multilayered 2,25 m pelmet	1 piece



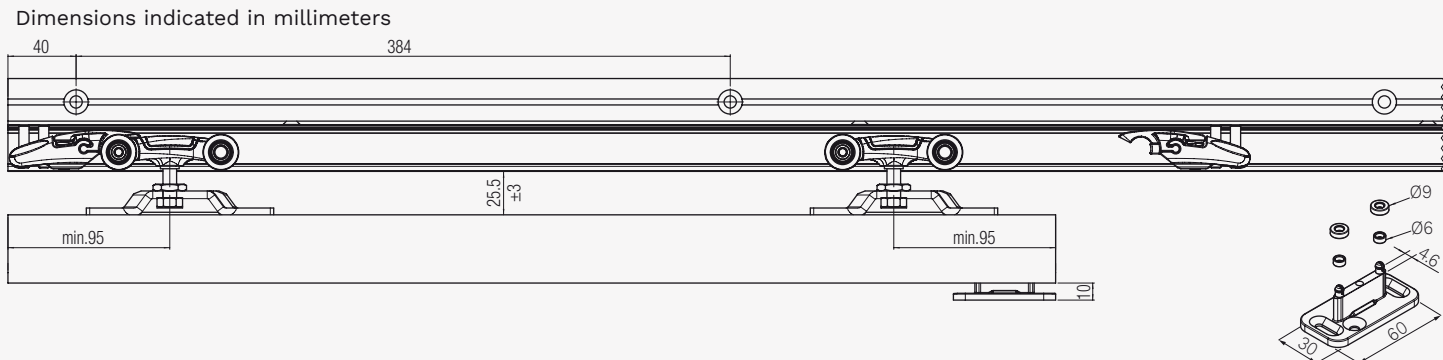

Technical drawings

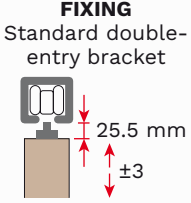
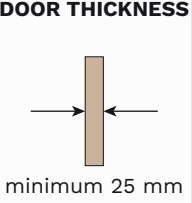
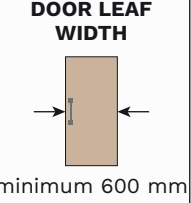

KIT 0500 60 21 ABS

PATENTED

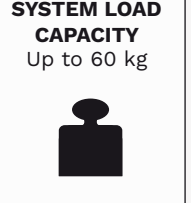
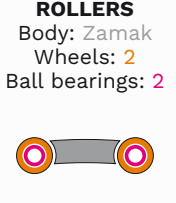
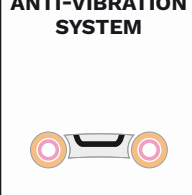
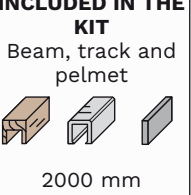
Standard sliding door kit with a track, a beam and a pelmet. Zamak roller, double-entry bracket, double ABS soft closing. Load capacity 60 kg.

SLIDING Standard 	FIXING Standard double-entry bracket  25.5 mm ±3	DOOR THICKNESS  minimum 25 mm	DOOR LEAF WIDTH  minimum 600 mm	DOOR MATERIAL Wood, Metal and PVC 	SYSTEM LOAD CAPACITY Up to 60 kg 	ROLLERS Body: Zamak Wheels: 2 Ball bearings: 2 
ANTI-VIBRATION SYSTEM 	SOFT-CLOSE ABS DOUBLE Type: Mechanic Covering: Steel		INCLUDED IN THE KIT Beam, track and pelmet  2000 mm			

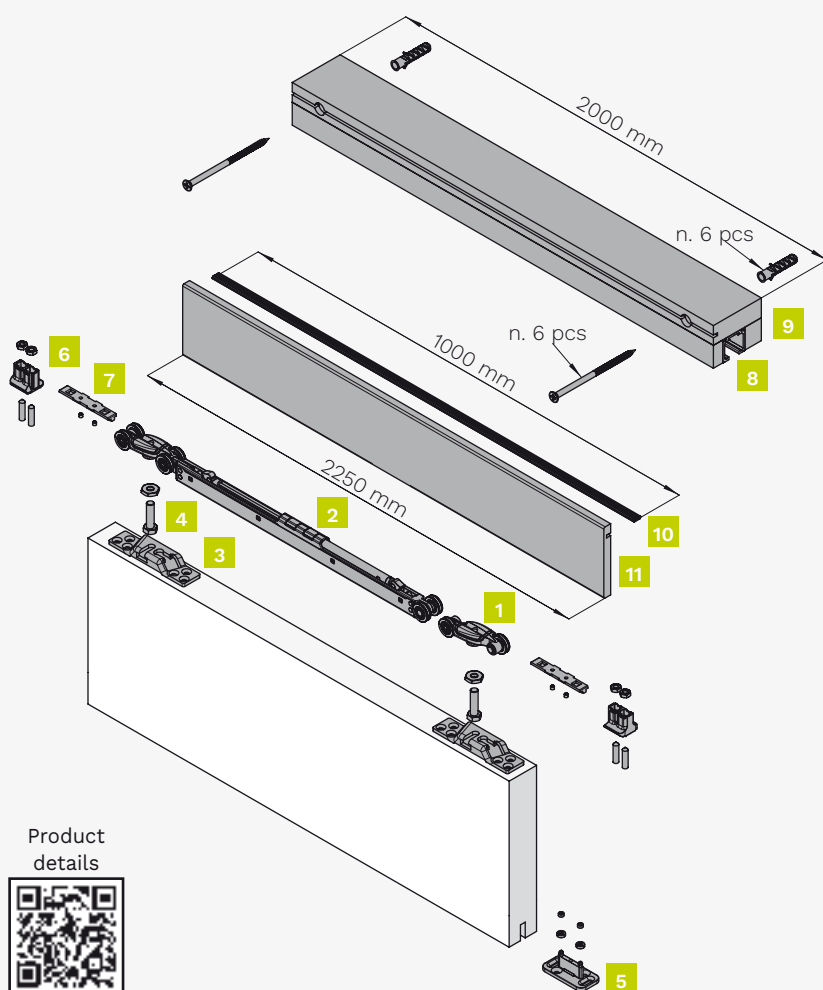

Kit components

1 door set
Item number: 0500 60 21 ABS

Figure	Component	Quantity
1	Upper roller - 60 kg	1 piece
2	Roller with soft close device (double ABS) - 60 kg	1 piece
3	Double hooking door bracket	2 pieces
4	Support screw for roller (hanger)	2 pieces
5	Adjustable lower guide	1 piece
6	Double ABS door stop	2 pieces
7	Double ABS activator	2 pieces
8	Pre-drilled and black anodised alu. track - 80 kg - 2 meters	1 piece
9	Pre-drilled multilayer wooden beam, black laminated - 80 kg - 2 meters	1 piece
10	Plastic profile for pelmet fixing - 1 meter	1 piece
11	Multilayered 2,25 m pelmet	1 piece

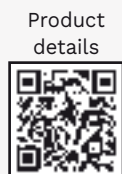

Technical drawings



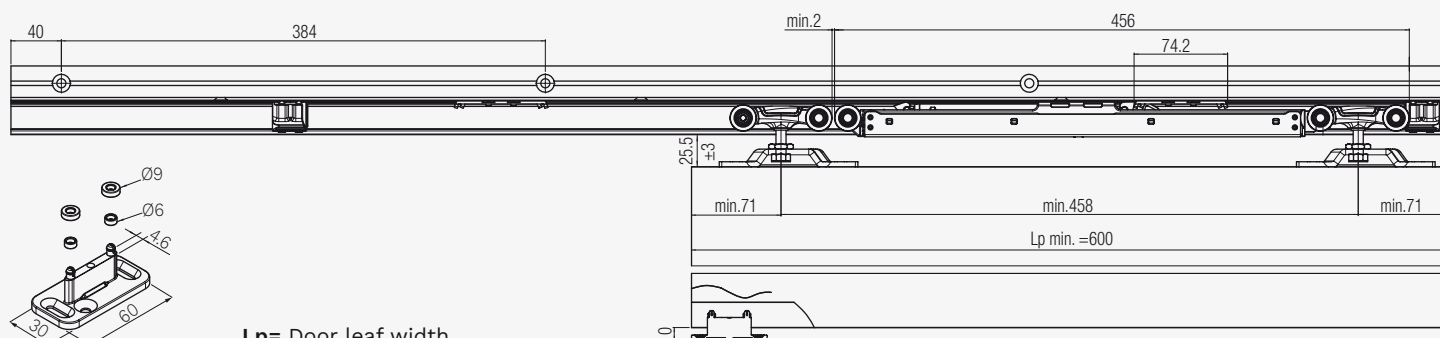

Dimensions indicated in millimeters

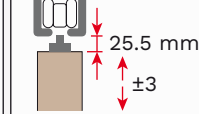
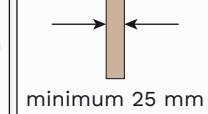
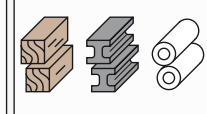

Lp= Door leaf width

KIT 0500 31 PATENTED

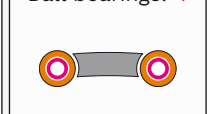
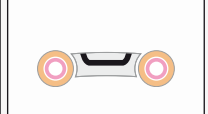
Standard sliding door kit with a track, a beam and a pelmet. Zamak roller, double-entry bracket, end-stop with adjustable unfasten force. Load capacity 80 kg.

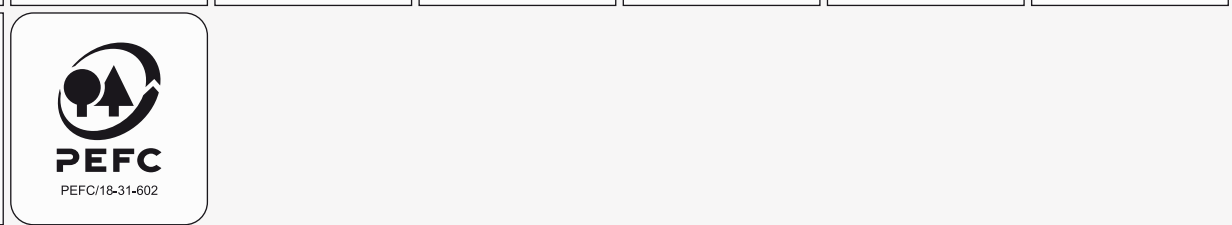
<p>SLIDING Standard</p> 	<p>FIXING Standard double-entry bracket</p> 	<p>DOOR THICKNESS</p> 	<p>DOOR MATERIAL Wood, Metal and PVC</p> 	<p>SYSTEM LOAD CAPACITY Up to 80 kg</p> 	<p>ROLLERS Body: Zamak Wheels: 4 Ball bearings: 4</p> 	<p>ANTI-VIBRATION SYSTEM</p> 
<p>INCLUDED IN THE KIT Beam, track and pelmet</p>  <p>2000 mm</p>						

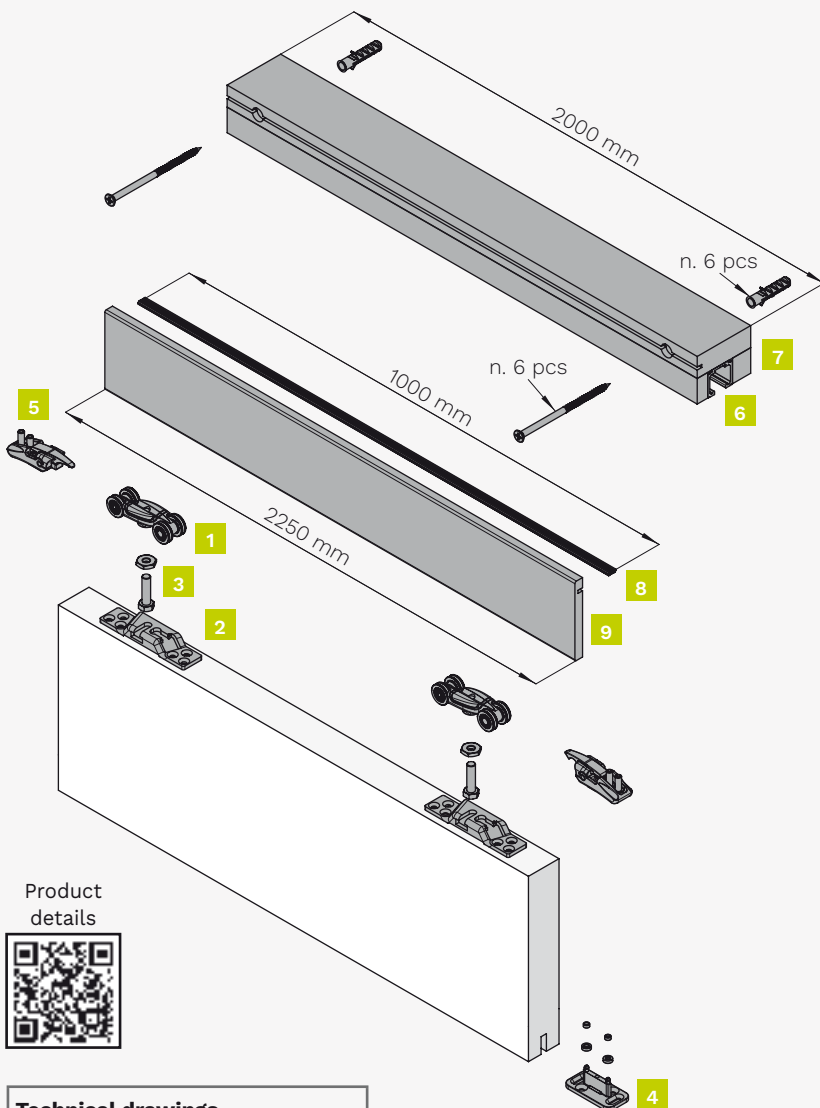

Kit components

1 door set
Item number: 0500 31

Figure	Component	Quantity
1	Upper roller - 120 kg	2 pieces
2	Double hooking door bracket	2 pieces
3	Support screw for roller (hanger)	2 pieces
4	Adjustable lower guide	1 piece
5	End-stop with adjustable unfasten force	2 pieces
6	Pre-drilled and black anodised alu. track - 80 kg - 2 meters	1 piece
7	Pre-drilled multilayer wooden beam, black laminated - 80 kg - 2 meters	1 piece
8	Plastic profile for pelmet fixing - 1 meter	1 piece
9	Multilayered 2,25 m pelmet	1 piece



Technical drawings

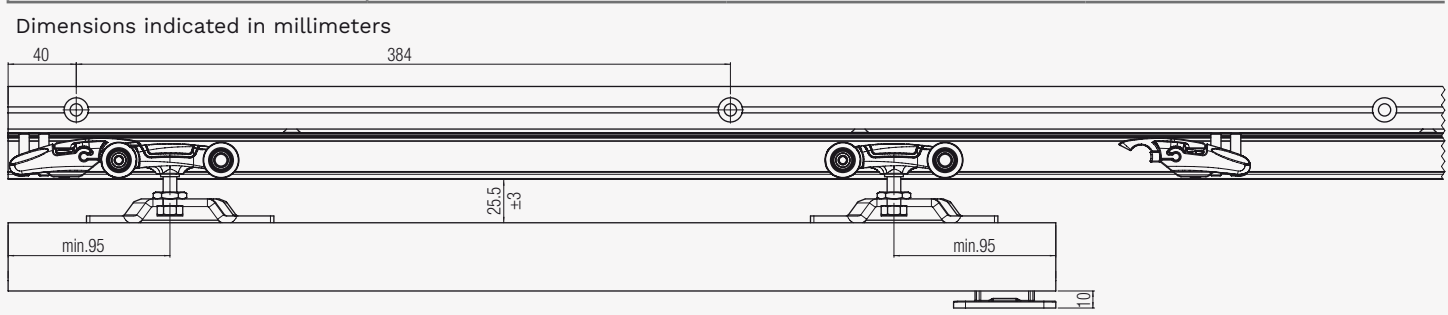

Tracks, Accessories and Spare parts 0500 21 / 0500 60 21 ABS / 0500 31

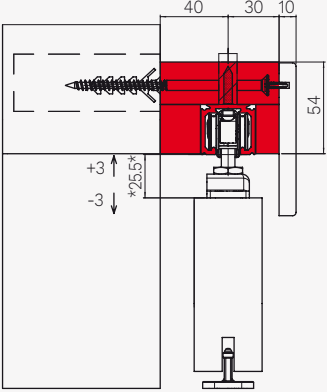
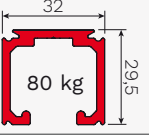



Installation examples	Dimensions tracks and accessories
<p>Dimensions indicated in millimeters</p> 	

Spare parts			
Component	*Quantity	Item number.	Which set is it for?
Upper roller - 60 kg	2 pieces	0500 51	0500 21 / 0500 60 21 ABS
Upper roller - 120 kg	2 pieces	0500 52	0500 31
Roller with soft close device (double ABS) - 60 kg	1 piece	0500 60 12 ABS	0500 60 21 ABS
Double ABS door stop	2 pieces		
Double ABS activator	2 pieces		
Double ABS activator	1 piece	0500 12 60 ABS	0500 60 21 ABS
Double hooking door bracket	2 pieces	0500 55	0500 21 / 0500 60 21 ABS / 0500 31
Support screw for roller (hanger)	2 pieces	0500 54	0500 21 / 0500 60 21 ABS / 0500 31
Adjustable lower guide	20 pieces	0500 13	0500 21 / 0500 60 21 ABS / 0500 31
End-stop with adjustable unfasten force	2 pieces	0500 12	0500 21 / 0500 31
Plastic profile for pelmet fixing - 1 meter	1 piece	0500 8	0500 21 / 0500 60 21 ABS / 0500 31
Multilayered 2,25 m pelmet	1 piece	0500 7.1	0500 21 / 0500 60 21 ABS / 0500 31
Pre-drilled and black anodised alu. track - 80 kg - 2 meters	1 piece	0500 200 N	0500 21 / 0500 60 21 ABS / 0500 31

*The minimum order quantity is indicated.

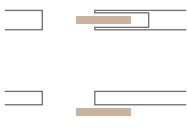
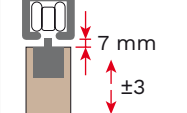
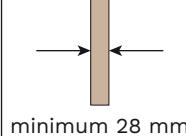
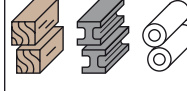
SYSTEM PREMIUM 0600

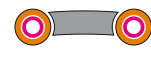
PATENTED

<p>SLIDING Standard</p> 	<p>FIXING Bracket embedded in the door</p> 	<p>DOOR THICKNESS</p>  <p>minimum 28 mm</p>	<p>DOOR MATERIAL Wood, Metal and PVC</p> 	<p>SYSTEM LOAD CAPACITY Up to 120 kg</p> 	<p>ROLLERS Body: Zamak Wheels: 2 or 4 Ball bearings: 2 or 4</p> 	<p>ANTI-VIBRATION SYSTEM</p> 
<p>SOFT-CLOSE</p> <p>ABS </p> <p>DOUBLE</p> <p>Type: Mechanic Covering: Steel</p>						



INDEX

A sliding set for Premium system 0600

Set	Load capacity	Door thickness	Sliding	Soft-close	Page
0600 60 ABS	60 kg	minimum 28 mm	Standard 	Yes	38
Tracks, Accessories and Spare parts 0600 60 ABS					39
0600 80	120 kg	minimum 28 mm	Standard 	No	40
0600 120 ABS	120 kg	minimum 28 mm	Standard 	Yes	41
Tracks, Accessories and Spare parts 0600 80 / 0600 120 ABS					42

Index

Terms

Slider
Wood Premium

Slider
Glass Premium

Basic
Slider

Outdoor
Slider

Design
Slider

Optional

Folding
solutions





Swinging
solutions

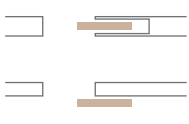
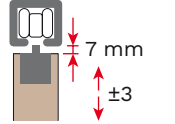
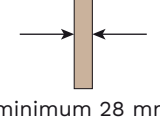
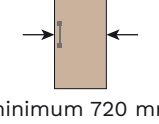
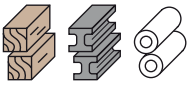

KIT 0600 60 ABS

PATENTED

Standard sliding door kit. Zamak roller ,built-in bracket, double ABS soft closing. Load capacity 60 kg.

<p>SLIDING Standard</p> 	<p>FIXING Bracket embedded in the door</p> 	<p>DOOR THICKNESS</p> 	<p>DOOR LEAF WIDTH</p> 	<p>DOOR MATERIAL Wood, Metal and PVC</p> 	<p>SYSTEM LOAD CAPACITY Up to 60 kg</p> 	<p>ROLLERS Body: Zamak Wheels: 2 Ball bearings: 2</p> 
<p>ANTI-VIBRATION SYSTEM</p> 	<p>SOFT-CLOSE</p> <p>ABS DOUBLE</p> <p>Type: Mechanic Covering: Steel</p>					

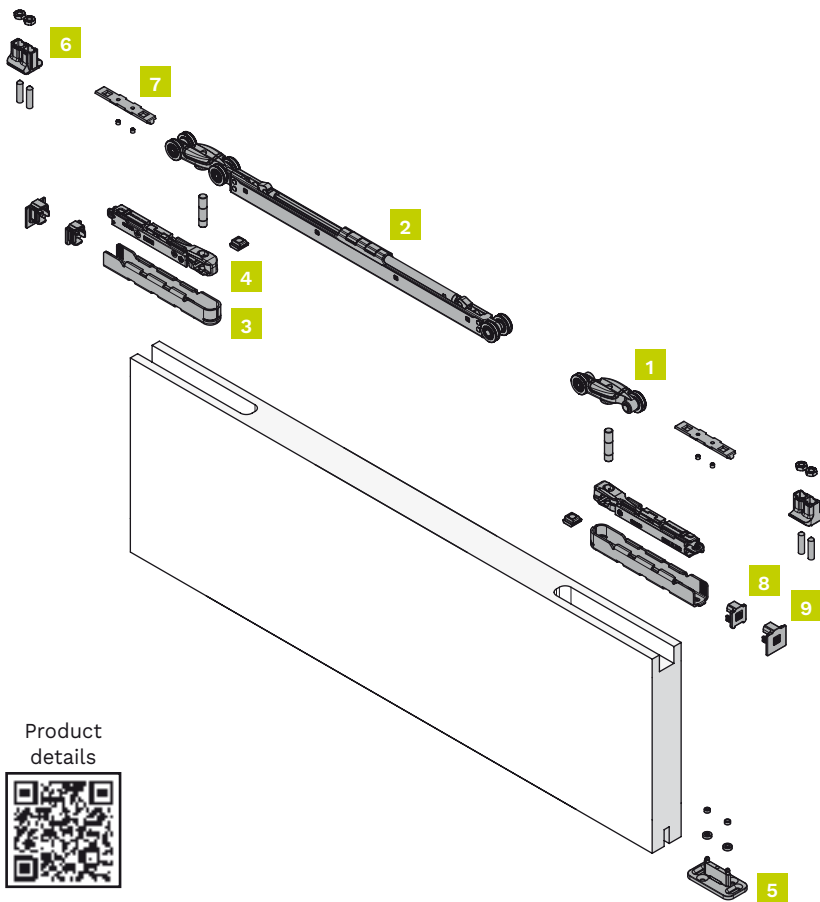

Kit components

1 door set

Item number: 0600 60 ABS

Figure	Component	Quantity
1	Upper roller - 60 kg	1 piece
2	Roller with soft close device (double ABS) - 60 kg	1 piece
3	Retainer profile (Screw not included)	2 pieces
4	Door anchor bracket	2 pieces
5	Adjustable lower guide	1 piece
6	Double ABS door stop	2 pieces
7	Double ABS activator	2 pieces
8	In line closing cap	2 pieces
9	Closing cap	2 pieces
-	Valve seat wrench	1 piece
-	Fork wrench profili	1 piece

Complete the set in the section "Tracks, Accessories and Spare parts".

Product details



Technical drawings

Dimensions indicated in millimeters

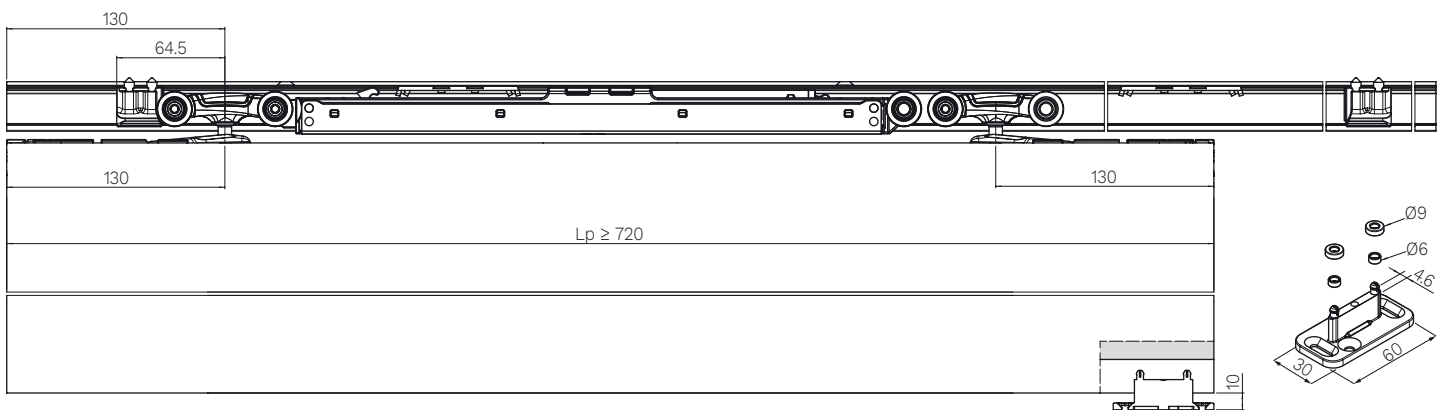

Lp= Door leaf width

Tracks, Accessories and Spare parts 0600 60 ABS

Complete the kit with track and accessory according to application.

Installation examples

Dimensions indicated in millimeters and are related to a 80 kg track. You can find the complete dimensions in the mounting instructions.

Dimensions tracks and accessories

Tracks	
Drilled and anodised aluminium track - 80 kg	Item number.
1,8 meters	0500 180
2 meters	0500 200
2,4 meters	0500 240
3 meters	0500 300
4 meters	0500 400
6 meters	0500 1
Drilled and anodised aluminium track - 120 kg	Item number.
3 meters	0500 10 300
6 meters	0500 10





Accessories	
Component	Item number.
False ceiling profile - 2 meters	0500 C 200
False ceiling profile - 3 meters	0500 C 300
False ceiling profile - 4 meters	0500 C 400
Wall fixing - 80 Kg - 2 meters	0500 F 200
Wall fixing - 80 Kg - 3 meters	0500 F 300
Wall fixing - 80 Kg - 4 meters	0500 F 400
Wall fixing - 120 Kg - 3 meters	0500 F 10 300
L shape wall fixing - 80 kg	0500 4
L shape wall fixing - 120 kg	0500 5
Track end cap	0500 61
Side closing wall fixing	0500 62

Spare parts			
Component	*Quantity	Item number.	Which set is it for?
Upper roller - 60 kg	2 pieces	0500 51	0600 60 ABS
Roller with soft close device (double ABS) - 60 kg	1 piece	0500 60 12 ABS	0600 60 ABS
Double ABS door stop	2 pieces		
Double ABS activator	2 pieces	0500 12 60 ABS	0600 60 ABS
Double ABS activator	1 piece		
Retainer profile (Screw not included)	2 pieces	0600 51	0600 60 ABS
Door anchor bracket (Screw not included)	2 pieces	0600 52	0600 60 ABS
Adjustable lower guide	20 pieces	0500 13	0600 60 ABS
In line closing cap	2 pieces	0600 54 F	0600 60 ABS
Closing cap	2 pieces	0600 54 S	0600 60 ABS
Fixing plates + screws for hooking profile to a wall	100 pieces	0500 58	0600 60 ABS

*The minimum order quantity is indicated.

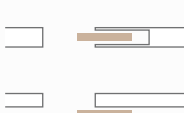
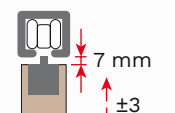
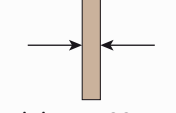
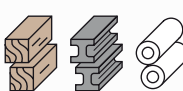
KIT 0600 80 PATENTED

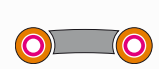
Standard sliding door kit. Zamak roller, built-in bracket, end-stop with adjustable unfasten force. Load capacity 120 kg.

<p>SLIDING Standard</p> 	<p>FIXING Bracket embedded in the door</p> 	<p>DOOR THICKNESS</p>  <p>minimum 28 mm</p>	<p>DOOR MATERIAL Wood, Metal and PVC</p> 	<p>SYSTEM LOAD CAPACITY Up to 120 kg</p> 	<p>ROLLERS Body: Zamak Wheels: 4 Ball bearings: 4</p> 	<p>ANTI-VIBRATION SYSTEM</p> 
---	---	---	---	--	--	---

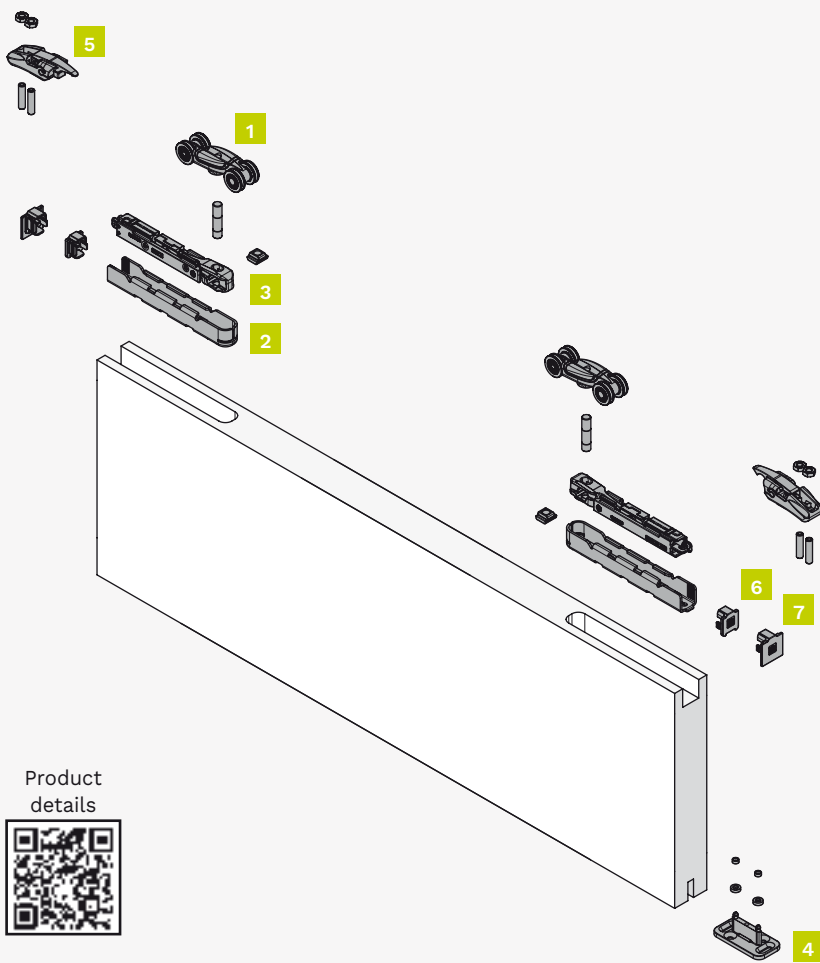

Kit components

1 door set
Item number: 0600 80

Figure	Component	Quantity
1	Upper roller - 120 kg	2 pieces
2	Retainer profile (Screw not included)	2 pieces
3	Door anchor bracket	2 pieces
4	Adjustable lower guide	1 piece
5	End-stop with adjustable unfasten force	2 pieces
6	In line closing cap	2 pieces
7	Closing cap	2 pieces
-	Valve seat wrench	1 piece
-	Fork wrench profili	1 piece

Complete the set in the section "Tracks, Accessories and Spare parts".

Product details



Technical drawings

Dimensions indicated in millimeters

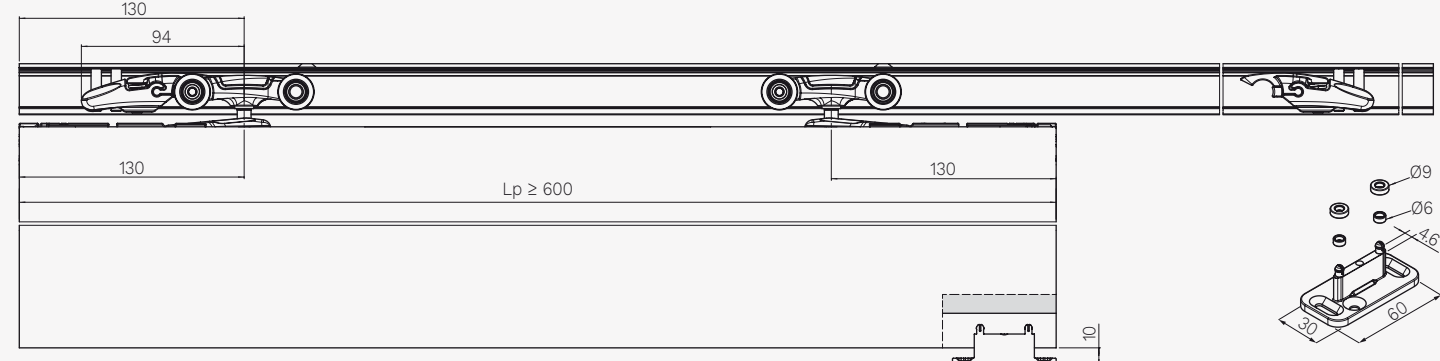

Lp= Door leaf width

KIT 0600 120 ABS

PATENTED

Standard sliding door kit. Zamak roller, built-in bracket, double ABS soft closing. Load capacity 120 kg.

SLIDING Standard 	FIXING Bracket embedded in the door 6.5 mm ±3	DOOR THICKNESS minimum 28 mm	DOOR LEAF WIDTH minimum 720 mm	DOOR MATERIAL Wood, Metal and PVC 	SYSTEM LOAD CAPACITY Up to 120 kg 	ROLLERS Body: Zamak Wheels: 4 Ball bearings: 4
ANTI-VIBRATION SYSTEM 	SOFT-CLOSE ABS DOUBLE Type: Mechanic Covering: Steel					

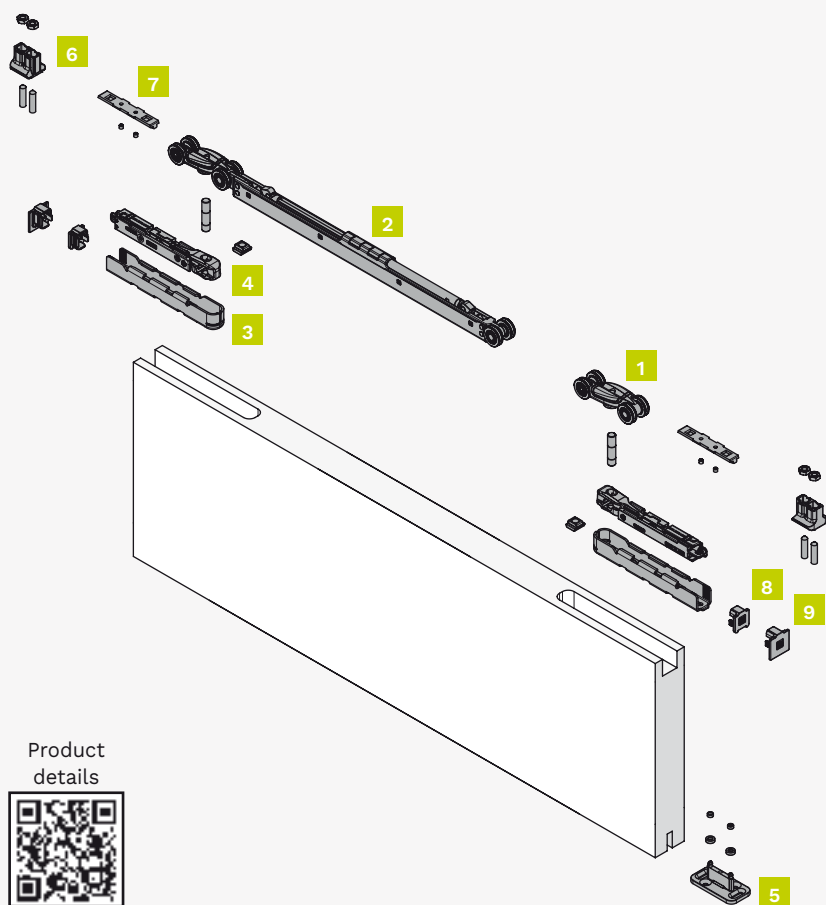

Kit components

1 door set
Item number: 0600 120 ABS

Figure	Component	Quantity
1	Upper roller - 120 kg	1 piece
2	Roller with soft close device (double ABS) - 120 kg	1 piece
3	Retainer profile (Screw not included)	2 pieces
4	Door anchor bracket	2 pieces
5	Adjustable lower guide	1 piece
6	Double ABS door stop	2 pieces
7	Double ABS activator	2 pieces
8	In line closing cap	2 pieces
9	Closing cap	2 pieces
-	Valve seat wrench	1 piece
-	Fork wrench profili	1 piece

Complete the set in the section "Tracks, Accessories and Spare parts".

Technical drawings

Dimensions indicated in millimeters

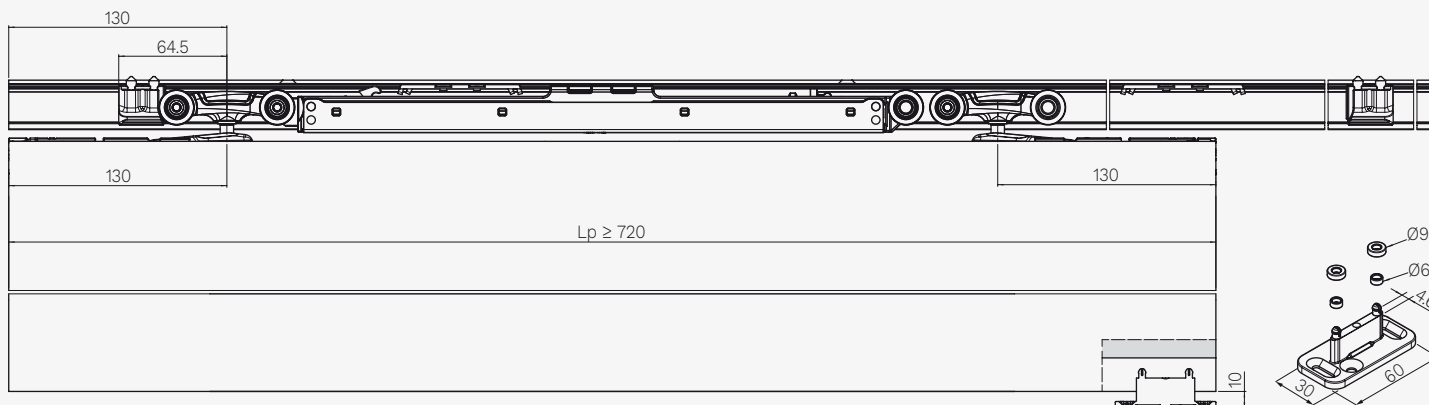

Lp= Door leaf width

Tracks, Accessories and Spare parts 0600 80 / 0600 120 ABS

Complete the kit with track and accessory according to application.

Installation examples

Dimensions indicated in millimeters and are related to a 120 kg track. You can find the complete dimensions in the mounting instructions.

Dimensions tracks and accessories

Tracks	
Drilled and anodised aluminium track - 120 kg	Item number.
3 meters	0500 10 300
6 meters	0500 10
Drilled and anodised aluminium track - 80 kg (for max. 80 kg door leaf only)	Item number.
1,8 meters	0500 180
2 meters	0500 200
2,4 meters	0500 240
3 meters	0500 300
4 meters	0500 400
6 meters	0500 1





Accessories	
Component	Item number.
False ceiling profile - 2 meters	0500 C 200
False ceiling profile - 3 meters	0500 C 300
False ceiling profile - 4 meters	0500 C 400
Wall fixing - 80 Kg - 2 meters	0500 F 200
Wall fixing - 80 Kg - 3 meters	0500 F 300
Wall fixing - 80 Kg - 4 meters	0500 F 400
Wall fixing - 120 Kg - 3 meters	0500 F 10 300
L shape wall fixing - 80 kg	0500 4
L shape wall fixing - 120 kg	0500 5
Track end cap	0500 61
Side closing wall fixing	0500 62

Spare parts			
Component	*Quantity	Item number.	Which set is it for?
Upper roller - 120 kg	2 pieces	0500 52	0600 80 / 0600 120 ABS
Roller with soft close device (double ABS) - 120 kg	1 piece	0500 120 12 ABS	0600 120 ABS
Double ABS door stop	2 pieces		
Double ABS activator	2 pieces		
Double ABS activator	1 piece	0500 12 60 ABS	0600 120 ABS
Retainer profile (Screw not included)	2 pieces	0600 51	0600 80 / 0600 120 ABS
Door anchor bracket (Screw not included)	2 pieces	0600 52	0600 80 / 0600 120 ABS
Adjustable lower guide	20 pieces	0500 13	0600 80 / 0600 120 ABS
End-stop with adjustable unfasten force	2 pieces	0500 12	0600 80
In line closing cap	2 pieces	0600 54 F	0600 80 / 0600 120 ABS
Closing cap	2 pieces	0600 54 S	0600 80 / 0600 120 ABS
Fixing plates + screws for hooking profile to a wall	100 pieces	0500 58	0600 80 / 0600 120 ABS

*The minimum order quantity is indicated.

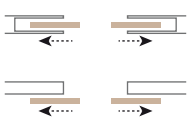
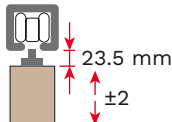
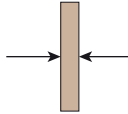
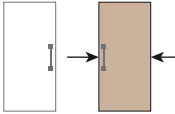
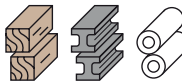
SYSTEM PREMIUM 0550

PATENTED

<p>SLIDING Simultaneous opening</p> 	<p>FIXING Standard double-entry bracket</p> 	<p>DOOR THICKNESS</p>  <p>minimum 25 mm</p>	<p>DOOR LEAF WIDTH</p>  <p>maximum 1050 mm</p>	<p>DOOR MATERIAL Wood, Metal and PVC</p> 	<p>SYSTEM LOAD CAPACITY Up to 240 kg (120 kg per door)</p> 	<p>ROLLERS Body: Zamak Wheels: 4 Ball bearings: 4</p> 
<p>ANTI-VIBRATION SYSTEM</p> 						



INDEX

A sliding set for Premium system 0550

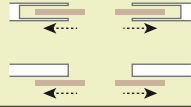
Set	Load capacity	Door thickness	Sliding	Page
0550 2	240 kg	minimum 25 mm	Simultaneous opening 	46
Tracks, Accessories and Spare parts 0550 2				47

KIT 0550 2 PATENTED

Two sliding simultaneous doors opening kit. Zamak roller, double-entry bracket, end-stop with adjustable unfasten force. Load capacity 240 kg.

<p>SLIDING Simultaneous opening</p>	<p>FIXING Standard double-entry bracket</p>	<p>DOOR THICKNESS</p> <p>minimum 25 mm</p>	<p>DOOR LEAF WIDTH</p> <p>maximum 1050 mm</p>	<p>DOOR MATERIAL Wood, Metal and PVC</p>	<p>SYSTEM LOAD CAPACITY Up to 240 kg (120 kg per door)</p>	<p>ROLLERS Body: Zamak Wheels: 4 Ball bearings: 4</p>
--	--	---	--	---	---	--

ANTI-VIBRATION SYSTEM

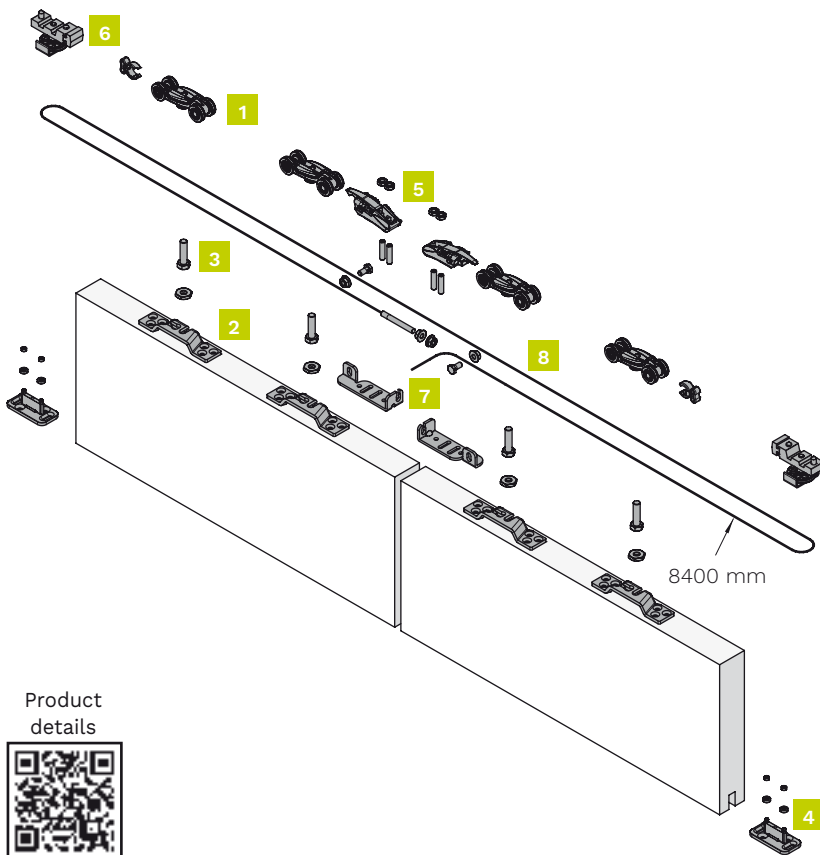

Kit components

2 doors set
Item number: 0550 2

Figure	Component	Quantity
1	Upper roller - 120 kg	4 pieces
2	Double hooking door bracket	4 pieces
3	Support screw for roller (hanger)	4 pieces
4	Adjustable lower guide	2 pieces
5	End-stop with adjustable unfasten force	2 pieces
6	Pulley door profiles	2 pieces
7	Cable bracket	2 pieces
8	Nylon covered steel cable - 8 meters	1 piece
-	Valve seat wrench	1 piece
-	Fork wrench	1 piece

Complete the set in the section "Tracks, Accessories and Spare parts".

Product details



Technical drawings

Dimensions indicated in millimeters

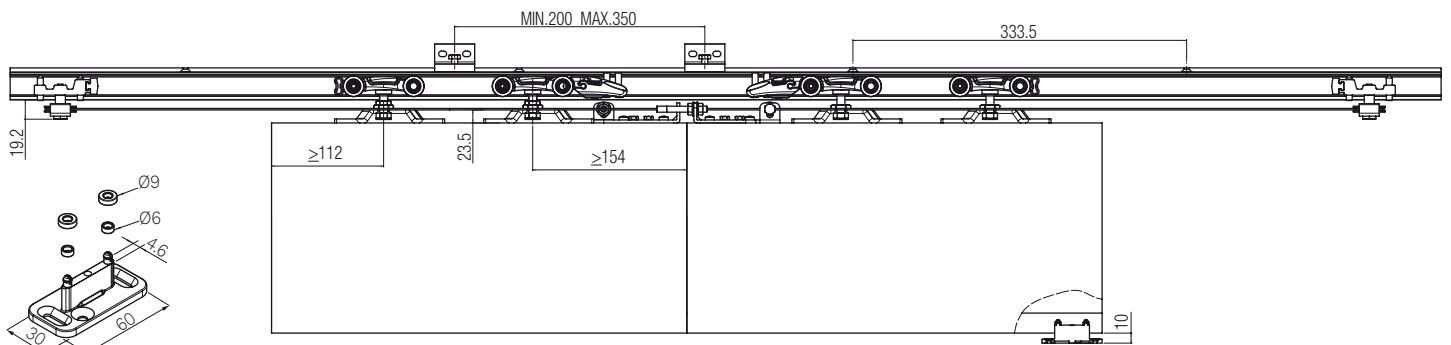

Tracks, Accessories and Spare parts 0550 2

Complete the kit with track and accessory according to application.

Installation examples				Dimensions tracks and accessories	
Dimensions indicated in millimeters and are related to a 80 kg track. You can find the complete dimensions in the mounting instructions.					

Tracks

Drilled and anodised aluminium track - 120 kg	Item number.
3 meters	0500 10 300
6 meters	0500 10
Drilled and anodised aluminium track - 80 kg (for max. 80 kg door leaf only)	Item number.
3 meters	0500 300
4 meters	0500 400
6 meters	0500 1

Accessories

Component	Item number.
Pelmet medium cover - 3 meters	0500 M 300
Pelmet medium cover - 4 meters	0500 M 400
Pelmet high cover - 3 meters	0500 A 300
Pelmet high cover - 4 meters	0500 A 400
Wall fixing - 80 Kg - 3 meters	0500 F 300
Wall fixing - 80 Kg - 4 meters	0500 F 400
Wall fixing - 120 Kg - 3 meters	0500 F 10 300
L shape wall fixing - 80 kg	0500 4
L shape wall fixing - 120 kg	0500 5
Track end cap	0500 61
Pelmet medium end cap	0500 63
Pelmet high end cap	0500 64





Spare parts

Component	*Quantity	Item number.	Which set is it for?
Upper roller - 120 kg	2 pieces	0500 52	0550 2
Double hooking door bracket	2 pieces	0500 55	0550 2
Support screw for roller (hanger)	2 pieces	0500 54	0550 2
Adjustable lower guide	20 pieces	0500 13	0550 2
End-stop with adjustable unfasten force	2 pieces	0500 12	0550 2
Pulley door profiles	2 pieces	1760 53	0550 2
Cable bracket	2 pieces	1760 51	0550 2
Nylon covered steel cable - 8 meters	1 piece	1760 50	0550 2
Fixing plates + screws for hooking profile to a wall	100 pieces	0500 58	0550 2

*The minimum order quantity is indicated.

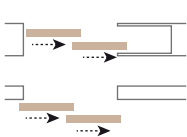
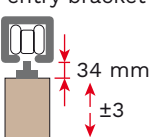
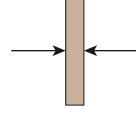
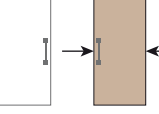
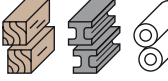
SYSTEM PREMIUM 0560

PATENTED

<p>SLIDING Telescopic doors</p> 	<p>FIXING Standard double-entry bracket</p> 	<p>DOOR THICKNESS</p>  <p>minimum 25 mm</p>	<p>DOOR LEAF WIDTH</p>  <p>maximum 1050 mm</p>	<p>DOOR MATERIAL Wood, Metal and PVC</p> 	<p>SYSTEM LOAD CAPACITY Up to 240 kg (120 kg per door)</p> 	<p>ROLLERS Body: Zamak Wheels: 4 Ball bearings: 4</p> 
<p>ANTI-VIBRATION SYSTEM</p> 						



INDEX

A sliding set for Premium system 0560

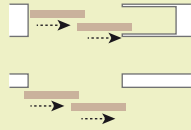
Set	Load capacity	Door thickness	Sliding	Page
0560 21	240 kg	minimum 25 mm	<p>Telescopic doors</p> 	50
Tracks, Accessories and Spare parts 0560 21				51

KIT 0560 21 PATENTED

Two sliding doors parallel opening kit. Zamak roller, double-entry bracket, end-stop with adjustable unfasten force. Load capacity 240 kg.

<p>SLIDING Telescopic doors</p>	<p>FIXING Standard double-entry bracket</p>	<p>DOOR THICKNESS</p>	<p>DOOR LEAF WIDTH</p>	<p>DOOR MATERIAL Wood, Metal and PVC</p>	<p>SYSTEM LOAD CAPACITY Up to 240 kg (120 kg per door)</p>	<p>ROLLERS Body: Zamak Wheels: 4 Ball bearings: 4</p>
--	--	------------------------------	-------------------------------	---	---	--

ANTI-VIBRATION SYSTEM

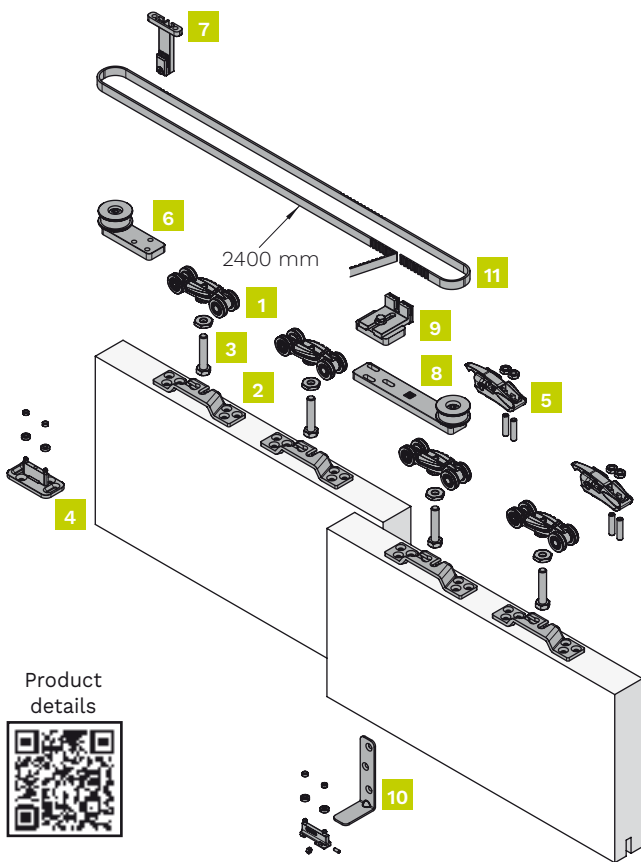

Product details



Kit components

2 doors set

Item number: 0560 21

Figure	Component	Quantity
1	Upper roller - 120 kg	4 pieces
2	Double hooking door bracket	4 pieces
3	Support screw for roller (hanger)	4 pieces
4	Adjustable lower guide	1 piece
5	End-stop with adjustable unfasten force	2 pieces
6	Rear pulley	1 piece
7	Fixed belt connector	1 piece
8	Front pulley	1 piece
9	Moving belt connector	1 piece
10	Adjustable lower guide - Fixed to the door	1 piece
11	Cog belt 2,4 m - door width max. mm 1000	1 piece
-	Valve seat wrench	1 piece
-	Fork wrench	1 piece

Complete the set in the section "Tracks, Accessories and Spare parts".

Technical drawings

Dimensions indicated in millimeters

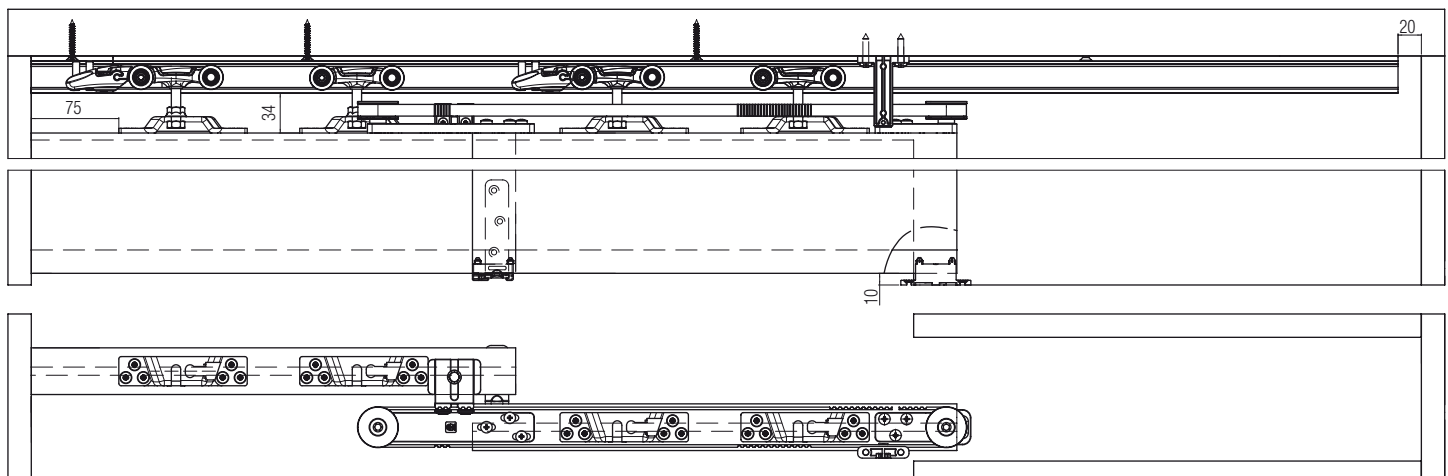

Tracks, Accessories and Spare parts 0560 21

Complete the kit with track and accessory according to application.

Installation examples

Dimensions indicated in millimeters and are related to a 80 kg track. You can find the complete dimensions in the mounting instructions.

Dimensions tracks and accessories

Tracks	
Drilled and anodised aluminium track - 120 kg	Item number.
3 meters	0500 10 300
6 meters	0500 10
Drilled and anodised aluminium track - 80 kg (for max. 80 kg door leaf only)	Item number.
3 meters	0500 300
4 meters	0500 400
6 meters	0500 1

Accessories	
Component	Item number.
Pelmet medium cover - 3 meters	0500 M 300
Pelmet medium cover - 4 meters	0500 M 400
Pelmet high cover - 3 meters	0500 A 300
Pelmet high cover - 4 meters	0500 A 400

Spare parts			
Component	*Quantity	Item number.	Which set is it for?
Upper roller - 120 kg	2 pieces	0500 52	0560 21
Double hooking door bracket	2 pieces	0500 55	0560 21
Support screw for roller (hanger)	2 pieces	0560 1	0560 21
Adjustable lower guide	20 pieces	0500 13	0560 21
End-stop with adjustable unfasten force	2 pieces	0500 12	0560 21
Adjustable lower guide - Fixed to the door	1 piece	2000 51	0560 21
Cog belt 3 m - door width max. mm 1300	1 piece	0560 10	0560 21

*The minimum order quantity is indicated.

PREMIUM SERIES

Glass door sliding systems









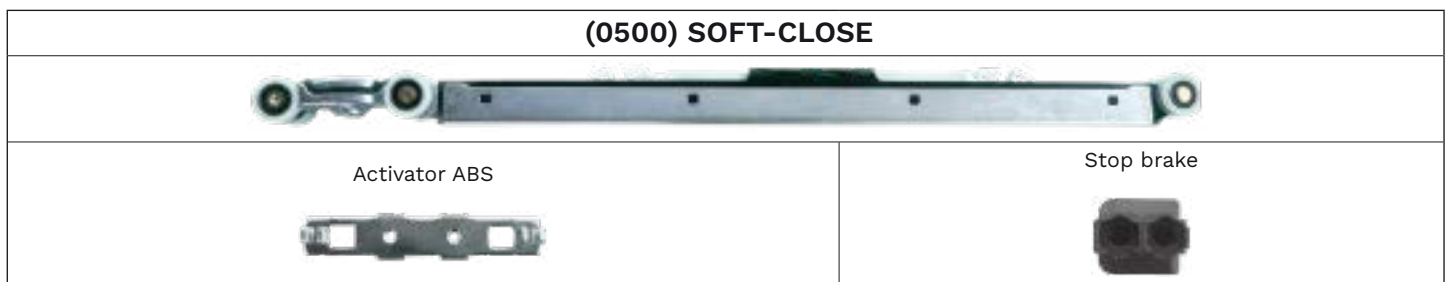
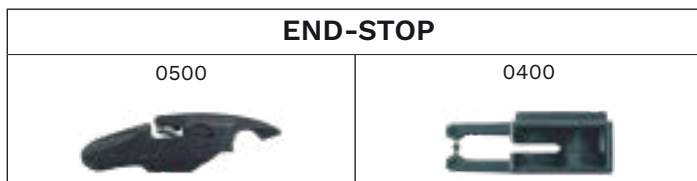
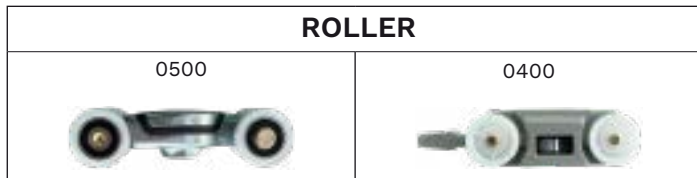

PREMIUM SERIES GLASS

PLUS:

1. **(0500) ROLLER** made of Zamak body and 4 POM (Polyoxymethylene) wheels with a ball bearing for a smooth sliding.
2. **(0400) ROLLER** made of **POM** (Polyoxymethylene) **body** and **wheels**. The 80 Kg version has a ball bearing per couple of wheels, in order to guarantee a better smoothness and fluidity.
3. **(0500) SHOCK ABSORBER**, a TPE shock absorber in the roller body allows a perfect sliding absorbing small unevenness in the track.
4. **(0500) SOFT CLOSE DEVICE** for soft opening and closing. Aluminum body, silent, integrated in the track and ultra-compact for installation also on narrow door leaf.
5. **(0400) SOFT CLOSE DEVICE** for soft opening or closing. The body made of POM is integrated in the track.
6. **(MAGNUS) MAGNETIC SOFT AND SELF OPENING AND CLOSING MACHANISM**, extremely silent, with a metal body integrated into the track. The compact form of the system allows to apply it on door leaves with a reduced width.
7. **FIXING** minimal-sized clamps and any hole in the glass needed.
8. **(0500) ADJUSTABLE END-STOP**, the unfasten force is adjustable by screwing a set screw.
9. **(0400) END-STOP**.
10. **ADJUSTABLE FLOOR GUIDE** according to the glass door leaf thickness by means of two eccentric cams.
11. Option to complete the kit with accessories.



System	Door material	Sliding	Fixing	Page
1730		Standard 	Clamp not requiring perforated glass	56
1730 + MAGNUS		Standard 	Clamp not requiring perforated glass	60
1730 + 0500		Standard 	Clamp not requiring perforated glass	64
1730 + 0400		Standard 	Clamp not requiring perforated glass	72

TERMS AND DEFINITIONS

• DOOR MATERIAL



Glass

• SLIDING



Standard

The solution that allows the creation of pocket and wall mounted sliding doors. It can be made with a **usual bracket** fixed in the upper part of the door or **embedded** in the door leaf when applied as flush to upper track.

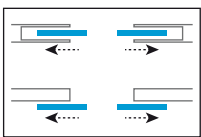

Simultaneous opening

The sliding solution that allows the creation of two coplanar doors with a synchronized and simultaneous opening, which even lets you only move one door. Both pocket door and wall mounted door solution.

• GLASS FIXING

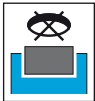

Clamp not requiring perforated glass

It DOES NOT require a safety hole in the glass during the installation.

• SOFT-CLOSE



Soft close device for soft opening or closing. The body made of POM is integrated in the track.



Soft close device for soft opening and closing. Aluminum body, silent, integrated in the track and ultra-compact for installation also on narrow door leaf.

• MAGNETIC SOFT AND SELF CLOSING MECHANISM



Magnetic soft and self opening or closing mechanism, extremely silent, with a metal body integrated into the track. The compact form of the system allows to apply it on door leaves with a reduced width.





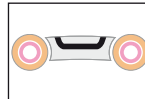

Magnetic soft and self opening and closing mechanism, extremely silent, with a metal body integrated into the track. The compact form of the system allows to apply it on door leaves with a reduced width.

• SHOCK ABSORBER

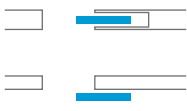
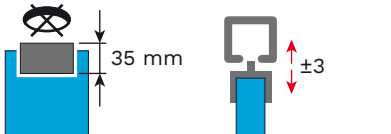
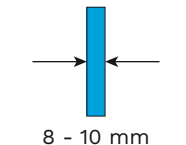

An element made of TPE (thermoplastic material) that allows the roller to absorb irregularities when sliding.

SYSTEM PREMIUM 1730

<p>SLIDING Standard</p> 	<p>FIXING Clamp not requiring perforated glass</p> 	<p>DOOR THICKNESS</p> 	<p>ROLLERS AND CAPACITY</p> <table border="1"> <thead> <tr> <th>MAGNUS</th> <th>0500</th> <th>0400</th> </tr> </thead> <tbody> <tr> <td>Body: Zamak</td> <td>Body: Zamak</td> <td>Body: POM</td> </tr> <tr> <td>Wheels: 4</td> <td>Wheels: 4</td> <td>Wheels: 4</td> </tr> <tr> <td>Ball bearings: 4</td> <td>Ball bearings: 4</td> <td>Ball bearings: 2</td> </tr> <tr> <td>Capacity: Up to 80 kg</td> <td>Capacity: Up to 120 kg</td> <td>Capacity: Up to 80 kg</td> </tr> </tbody> </table>			MAGNUS	0500	0400	Body: Zamak	Body: Zamak	Body: POM	Wheels: 4	Wheels: 4	Wheels: 4	Ball bearings: 4	Ball bearings: 4	Ball bearings: 2	Capacity: Up to 80 kg	Capacity: Up to 120 kg	Capacity: Up to 80 kg
MAGNUS	0500	0400																		
Body: Zamak	Body: Zamak	Body: POM																		
Wheels: 4	Wheels: 4	Wheels: 4																		
Ball bearings: 4	Ball bearings: 4	Ball bearings: 2																		
Capacity: Up to 80 kg	Capacity: Up to 120 kg	Capacity: Up to 80 kg																		
<p>DOOR MATERIAL Glass</p> 	<p>MAGNETIC SOFT AND SELF CLOSING MECHANISM Only applicable to roller MAGNUS</p> <p>ABS </p> <p>SINGLE / DOUBLE</p> <p>Type: Magnetic Covering: Steel</p>		<p>SOFT-CLOSE Only applicable to roller 0500</p> <p>ABS </p> <p>DOUBLE</p> <p>Type: Mechanic Covering: Steel</p>	<p>SOFT-CLOSE Only applicable to roller 0400</p> <p>ABS </p> <p>SINGLE</p> <p>Type: Mechanic Covering: Plastic</p>																

Rollers and door return mechanism compatible with system 1730 are to be purchased separately.





INDEX

A sliding set for Premium system 1730

Set	Door thickness	Sliding	Notes	Page
1730 120	8 - 10 mm	Standard 	To be combined with a sliding system	58
Tracks, Accessories and Spare parts 1730 120				59

KIT 1730 120

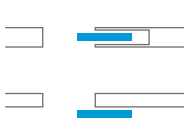
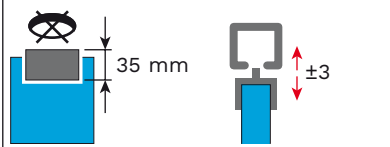
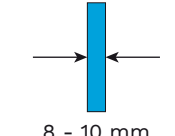
Kit for sliding glass door for standard internal/external wall application, No hole needed in the glass for clamps fixing. Maximum load 120 kg.

<p>SLIDING Standard</p> 	<p>FIXING Clamp not requiring perforated glass</p>  <p>35 mm</p> <p>±3</p>	<p>DOOR THICKNESS</p>  <p>8 - 10 mm</p>	<p>ROLLERS AND CAPACITY</p> <table border="1"> <tr> <td data-bbox="885 302 1093 470"> <p>MAGNUS Body: Zamak Wheels: 4 Ball bearings: 4 Capacity: Up to 80 kg</p> </td> <td data-bbox="1093 302 1300 470"> <p>0500 Body: Zamak Wheels: 4 Ball bearings: 4 Capacity: Up to 120 kg</p> </td> <td data-bbox="1300 302 1508 470"> <p>0400 Body: POM Wheels: 4 Ball bearings: 2 Capacity: Up to 80 kg</p> </td> </tr> </table>			<p>MAGNUS Body: Zamak Wheels: 4 Ball bearings: 4 Capacity: Up to 80 kg</p>	<p>0500 Body: Zamak Wheels: 4 Ball bearings: 4 Capacity: Up to 120 kg</p>	<p>0400 Body: POM Wheels: 4 Ball bearings: 2 Capacity: Up to 80 kg</p>
<p>MAGNUS Body: Zamak Wheels: 4 Ball bearings: 4 Capacity: Up to 80 kg</p>	<p>0500 Body: Zamak Wheels: 4 Ball bearings: 4 Capacity: Up to 120 kg</p>	<p>0400 Body: POM Wheels: 4 Ball bearings: 2 Capacity: Up to 80 kg</p>						
<p>DOOR MATERIAL Glass</p> 	<p>MAGNETIC SOFT AND SELF CLOSING MECHANISM Only applicable to roller MAGNUS</p> <p>ABS</p> <p>SINGLE / DOUBLE</p> <p>Type: Magnetic Covering: Steel</p>		<p>SOFT-CLOSE Only applicable to roller 0500</p> <p>ABS</p> <p>DOUBLE</p> <p>Type: Mechanic Covering: Steel</p>		<p>SOFT-CLOSE Only applicable to roller 0400</p> <p>ABS</p> <p>SINGLE</p> <p>Type: Mechanic Covering: Plastic</p>			

Rollers and door return mechanism compatible with system 1730 are to be purchased separately.

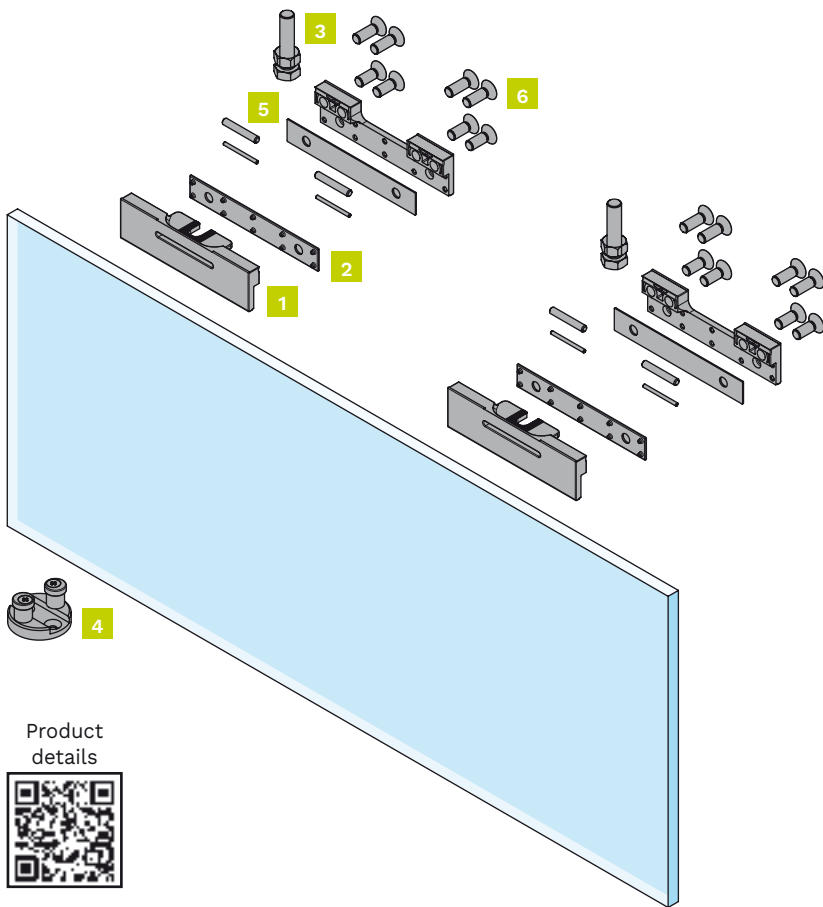

Kit components

1 door set
Item number: 1730 120

Figure	Component	Quantity
1	Glass anchoring clamp	2 pieces
2	Glass seal	4 pieces
3	Roller support screw + nut	2 pieces
4	Adjustable floor guide	1 piece
5	Pins	4 pieces
6	Screws	16 pieces
-	Fork wrench	1 piece

Complete the set in the section "Tracks, Accessories and Spare parts".

Technical drawings

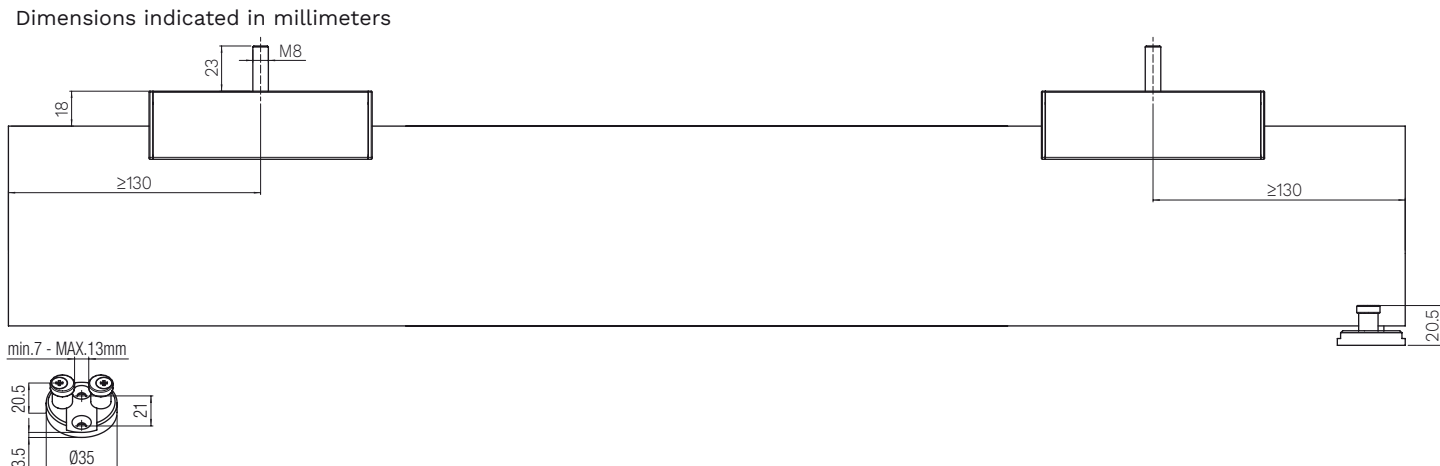

Tracks, Accessories and Spare parts 1730 120

Complete the kit with roller, stop brake, track and accessory according to application.

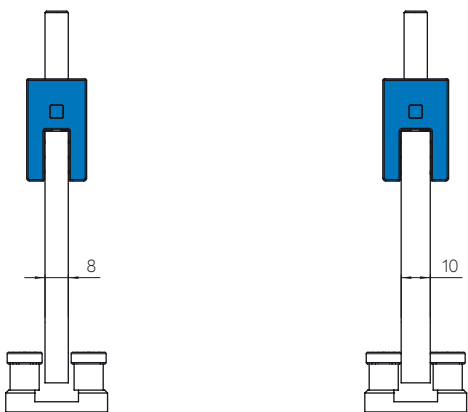
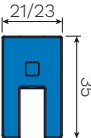
Installation examples	Dimensions tracks and accessories
<p>You can find the complete dimensions in the mounting instructions.</p> 	

Sliding door kit		
MAGNUS	*Quantity	Item number.
Standard sliding door kit, single magnetic damper - 80 kg	1 piece	0570 10 ABS
Standard sliding door kit, double side magnetic damper - 80 kg	1 piece	0570 20 ABS
0500	*Quantity	Item number.
Standard sliding door kit, double mechanical damper - 60 kg	1 piece	0500 60
Standard sliding door kit, double mechanical damper - 120 kg	1 piece	0500 120
Standard sliding door kit - 60 kg	1 piece	0500 2 1730
Standard sliding door kit - 120 kg	1 piece	0500 120 1730
0400	*Quantity	Item number.
Standard sliding door kit - 40 kg	1 piece	0400 3 1730
Standard sliding door kit - 80 kg	1 piece	0400 4 1730
Standard sliding door kit, single mechanical damper - 60 kg	1 piece	0400 4 1730 ABS

*The minimum order quantity is indicated.

Accessories	
Component	Item number.
Silver anodized glass clamp cover	1730 120 COVER
Stainless steel effect anodized glass clamp cover	1730 120 COVER EA
Silver anodized glass clamp cover	1730 120 1240
Stainless steel effect anodized glass clamp cover	1730 120 1240 EA
Adjustable rear stop	1730 120 2





Spare parts			
Component	*Quantity	Item number.	Which set is it for?
Seals, caps and spacers kit	1 piece	1730 1 120	1730 120

*The minimum order quantity is indicated.

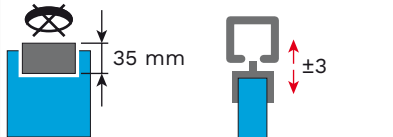
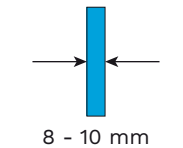

SYSTEM 1730 + MAG·NUS

PAT-PENDING

<p>SLIDING Standard</p> 	<p>FIXING Clamp not requiring perforated glass</p> 	<p>DOOR THICKNESS</p> 	<p>DOOR MATERIAL Glass</p> 	<p>SYSTEM LOAD CAPACITY from 20 kg to 80 kg</p> 	<p>ROLLERS Body: Zama Wheels: 4 Ball bearings: 4</p> 
<p>SMOOTH DOOR RELEASE</p> <p>Opening effort reduced by 50% compared to traditional systems</p>	<p>VERY QUIET</p>  <p>No hooking click sound</p>	<p>MAGNETIC SOFT AND SELF CLOSING MECHANISM</p> <p>ABS ●●●●●●●●</p> <p>SINGLE / DOUBLE</p> <p>Type: Magnetic Covering: Steel</p>			



SYSTEM 1730 + Single ABS Magnus fixing set for the door and the lower track

Fixing with **glass clamp** and adjustable lower guide



Kit components

1 door set

Item number: 1730 120

Figure	Component	Quantity
1	Glass anchoring clamp	2 pieces
2	Glass seal	4 pieces
3	Roller support screw + nut	2 pieces
4	Adjustable floor guide	1 piece
5	Pins	4 pieces
-	Screws	16 pieces
-	Fork wrench	1 piece

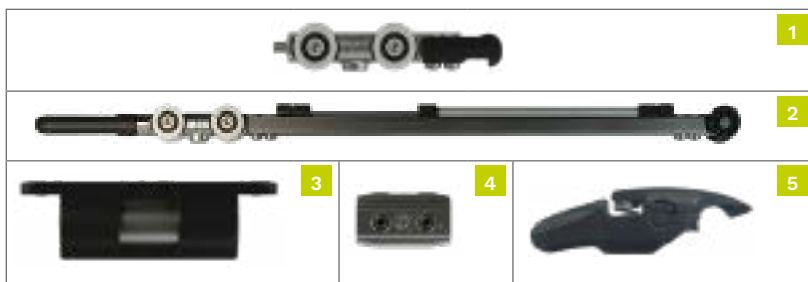

Kit components

1 door set

Item number: 0570 10 ABS

Figure	Component	Quantity
1	Roller without magnet	1 piece
2	Roller with Magnetic soft close	1 piece
3	Soft close Activator - Magnus	1 piece
4	Braking activator - Magnus	1 piece
5	End-stop with adjustable unfasten force	1 piece
-	Valve seat wrench	1 piece

Complete the set in the section "Tracks, floor guide, Accessories and Spare parts".

Technical drawings

Dimensions indicated in millimeters

Solution with item code **0570 10 ABS** + item code **1730 120** - load capacity up to 80 kg

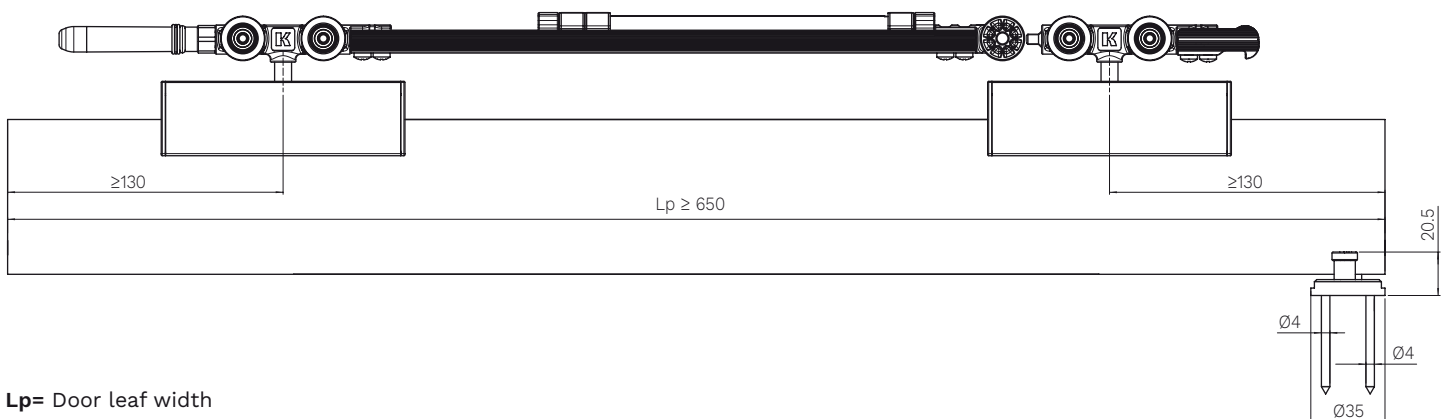

Lp= Door leaf width

SYSTEM 1730 + Double ABS Magnus fixing set for the door and the lower track

Fixing with **glass clamp** and adjustable lower guide



Kit components

1 door set

Item number: 1730 120

Figure	Component	Quantity
1	Glass anchoring clamp	2 pieces
2	Glass seal	4 pieces
3	Roller support screw + nut	2 pieces
4	Adjustable floor guide	1 piece
5	Pins	4 pieces
-	Screws	16 pieces
-	Fork wrench	1 piece

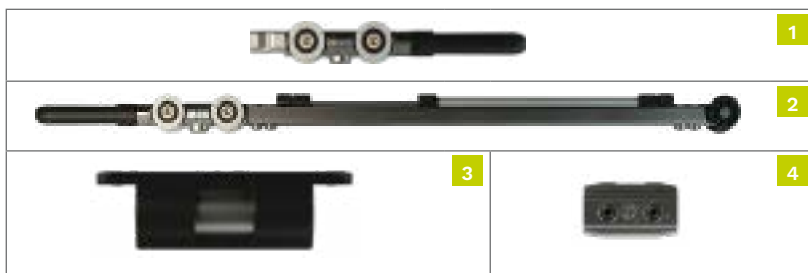

Kit components

1 door set

Item number: 0570 20 ABS

Figure	Component	Quantity
1	Roller with magnet	1 piece
2	Roller with Magnetic soft close	1 piece
3	Soft close Activator - Magnus	2 pieces
4	Braking activator - Magnus	2 pieces
-	Valve seat wrench	1 piece

Complete the set in the section "Tracks, floor guide, Accessories and Spare parts".

Technical drawings

Dimensions indicated in millimeters

Solution with item code **0570 20 ABS** + item code **1730 120** - load capacity up to 80 kg

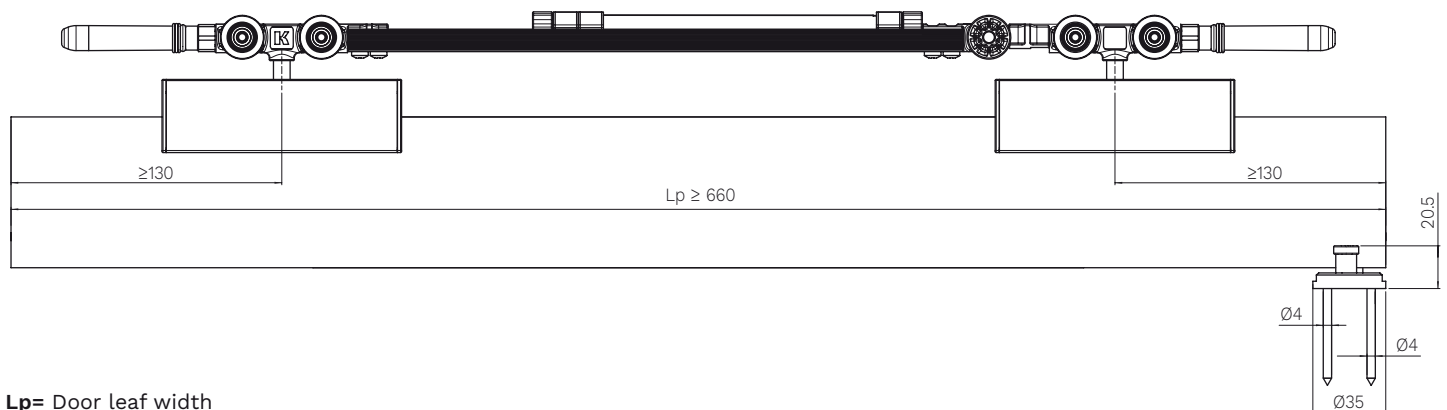

Lp= Door leaf width

Single ABS Magnus and Double ABS Magnus Tracks, Accessories and Spare parts

Complete the kit with track and accessory according to application.

Installation examples

You can find the complete dimensions in the mounting instructions.

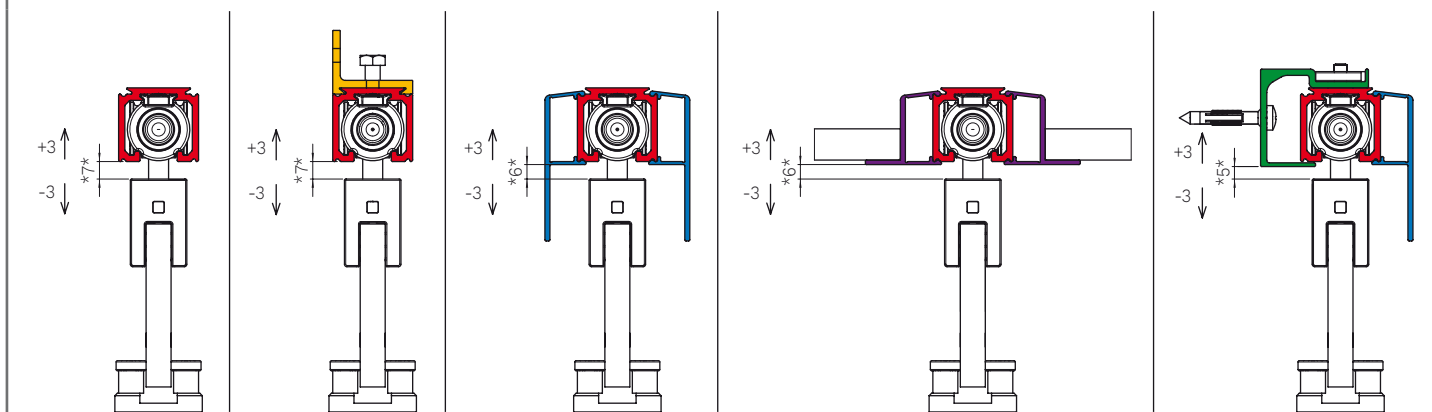

Dimensions tracks and accessories

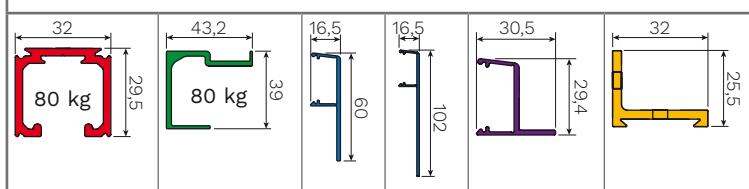

Tracks

Drilled and anodised aluminium track - 80 kg	Item number.
1,8 meters	0500 180
2 meters	0500 200
2,4 meters	0500 240
3 meters	0500 300
4 meters	0500 400
6 meters	0500 1

Accessories

Component	Item number.
Pelmet high cover - 2 meters	0500 A 200
Pelmet high cover - 3 meters	0500 A 300
Pelmet high cover - 4 meters	0500 A 400
Pelmet medium cover - 2 meters	0500 M 200
Pelmet medium cover - 3 meters	0500 M 300
Pelmet medium cover - 4 meters	0500 M 400
False ceiling profile - 2 meters	0500 C 200
False ceiling profile - 3 meters	0500 C 300
False ceiling profile - 4 meters	0500 C 400
Wall fixing - 80 Kg - 2 meters	0500 F 200
Wall fixing - 80 Kg - 3 meters	0500 F 300
Wall fixing - 80 Kg - 4 meters	0500 F 400
L shape wall fixing - 80 kg	0500 4
Pelmet medium end cap	0500 63
Pelmet high end cap	0500 64







Spare parts

Component	*Quantity	Item number.	Which set is it for?
Roller with Magnetic soft close	1 piece	0570 ABS	MAGNUS ABS single / MAGNUS ABS double
Braking activator	1 piece		
Roller without magnet	1 piece	0570 1 ABS	MAGNUS ABS single
End-stop with adjustable unfasten force	1 piece		
Roller with magnet	1 piece	0570 2 ABS	MAGNUS ABS double
Soft close Activator	1 piece		
Braking activator	1 piece	0570 ABS 3	MAGNUS ABS single / MAGNUS ABS double
Soft close Activator	1 piece		
Braking activator	1 piece		
End-stop with adjustable unfasten force	1 piece		

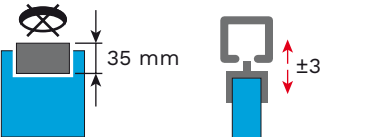
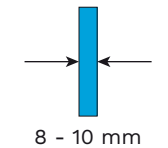
*The minimum order quantity is indicated.

SYSTEM 1730 + 0500

PATENTED

<p>SLIDING Standard</p> 	<p>FIXING Clamp not requiring perforated glass</p> 	<p>DOOR THICKNESS</p> 	<p>DOOR MATERIAL Glass</p> 	<p>SYSTEM LOAD CAPACITY Up to 120 kg</p> 
<p>ROLLERS Body: Zamak Wheels: 2 or 4 Ball bearings: 2 or 4</p> 	<p>ANTI-VIBRATION SYSTEM</p> 	<p>SOFT-CLOSE</p> <p>ABS </p> <p>DOUBLE</p> <p>Type: Mechanic Covering: Steel</p>		



SYSTEM 1730 + 0500 2 1730 fixing set for the door and the lower track

Fixing with **glass clamp** and adjustable lower guide



Kit components

1 door set

Item number: 1730 120

Figure	Component	Quantity
1	Glass anchoring clamp	2 pieces
2	Glass seal	4 pieces
3	Roller support screw + nut	2 pieces
4	Adjustable floor guide	1 piece
5	Pins	4 pieces
-	Screws	16 pieces
-	Fork wrench	1 piece



Kit components

1 door set

Item number: 0500 2 1730

Figure	Component	Quantity
1	Upper roller - 60 kg	2 pieces
2	End-stop with adjustable unfasten force	2 pieces

Complete the set in the section "Tracks, floor guide, Accessories and Spare parts".

Technical drawings

Dimensions indicated in millimeters

Solution with item code **0500 2 1730** + item code **1730 120** - load capacity up to 60 kg

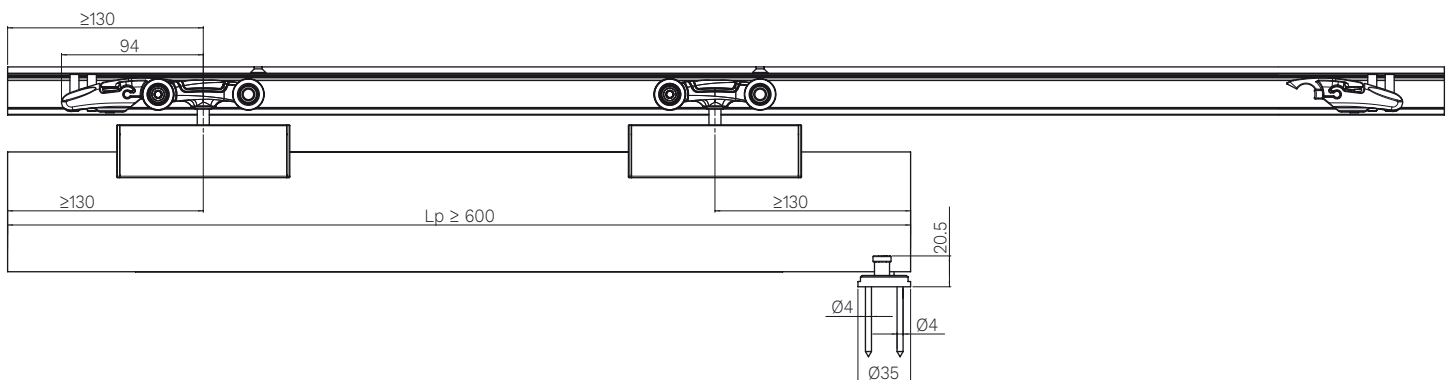

Lp= Door leaf width

SYSTEM 1730 + 0500 60 fixing set for the door and the lower track

Fixing with **glass clamp** and adjustable lower guide



Kit components

1 door set

Item number: 1730 120

Figure	Component	Quantity
1	Glass anchoring clamp	2 pieces
2	Glass seal	4 pieces
3	Roller support screw + nut	2 pieces
4	Adjustable floor guide	1 piece
5	Pins	4 pieces
-	Screws	16 pieces
-	Fork wrench	1 piece



Kit components

1 door set

Item number: 0500 60

Figure	Component	Quantity
1	Upper roller - 60 kg	1 piece
2	Roller with soft close device (double ABS) - 60 kg	1 piece
3	Double ABS door stop	2 pieces
4	Double ABS activator	2 pieces

Complete the set in the section "Tracks, floor guide, Accessories and Spare parts".

Technical drawings

Dimensions indicated in millimeters

Solution with item code **0500 60** + item code **1730 120** - load capacity up to 60 kg

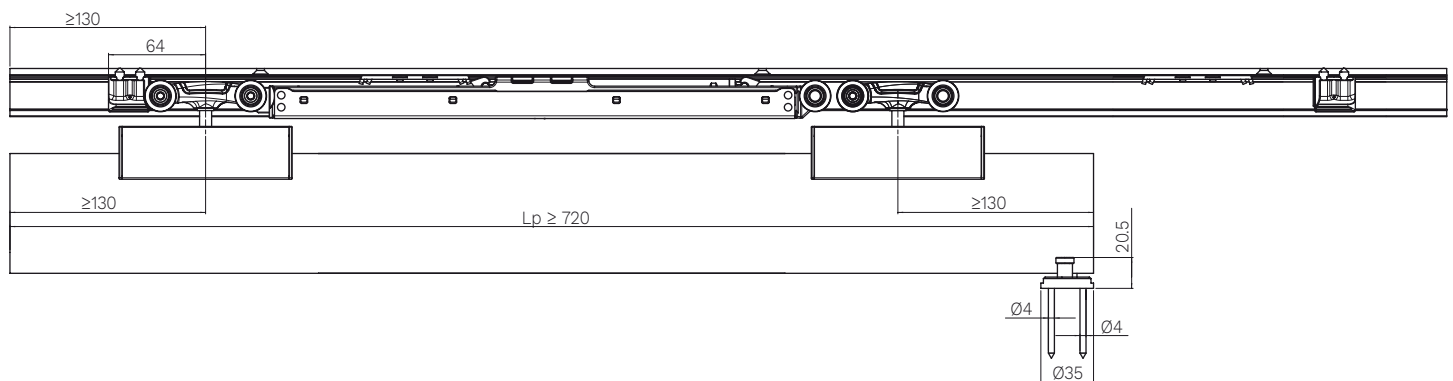

Lp= Door leaf width

Tracks, Accessories and Spare parts 0500 2 1730 / 0500 60

Complete the kit with track and accessory according to application.

Installation examples

Dimensions indicated in millimeters and are related to a 80 kg track. You can find the complete dimensions in the mounting instructions.

Dimensions tracks and accessories

Tracks	
Drilled and anodised aluminium track - 80 kg	Item number.
1,8 meters	0500 180
2 meters	0500 200
2,4 meters	0500 240
3 meters	0500 300
4 meters	0500 400
6 meters	0500 1
Drilled and anodised aluminium track - 120 kg	Item number.
3 meters	0500 10 300
6 meters	0500 10

Accessories	
Component	Item number.
Pelmet high cover - 2 meters	0500 A 200
Pelmet high cover - 3 meters	0500 A 300
Pelmet high cover - 4 meters	0500 A 400
Pelmet medium cover - 2 meters	0500 M 200
Pelmet medium cover - 3 meters	0500 M 300
Pelmet medium cover - 4 meters	0500 M 400
Wall fixing - 80 Kg - 2 meters	0500 F 200
Wall fixing - 80 Kg - 3 meters	0500 F 300
Wall fixing - 80 Kg - 4 meters	0500 F 400
Wall fixing - 120 Kg - 3 meters	0500 F 10 300
L shape wall fixing - 80 kg	0500 4
L shape wall fixing - 120 kg	0500 5
Track end cap	0500 61
Pelmet medium end cap	0500 63
Pelmet high end cap	0500 64

Spare parts			
Component	*Quantity	Item number.	Which set is it for?
Upper roller - 60 kg	2 pieces	0500 51	0500 2 1730 / 0500 60
Roller with soft close device (double ABS) - 60 kg	1 piece	0500 60 12 ABS	0500 60
Double ABS door stop	2 pieces		
Double ABS activator	2 pieces		
Double ABS activator	1 piece	0500 12 60 ABS	0500 60
End-stop with adjustable unfasten force	2 pieces	0500 12	0500 2 1730
Fixing plates + screws for hooking profile to a wall	100 pieces	0500 58	0500 2 1730 / 0500 60

*The minimum order quantity is indicated.

SYSTEM 1730 + 0500 120 1730 fixing set for the door and the lower track

Fixing with **glass clamp** and adjustable lower guide

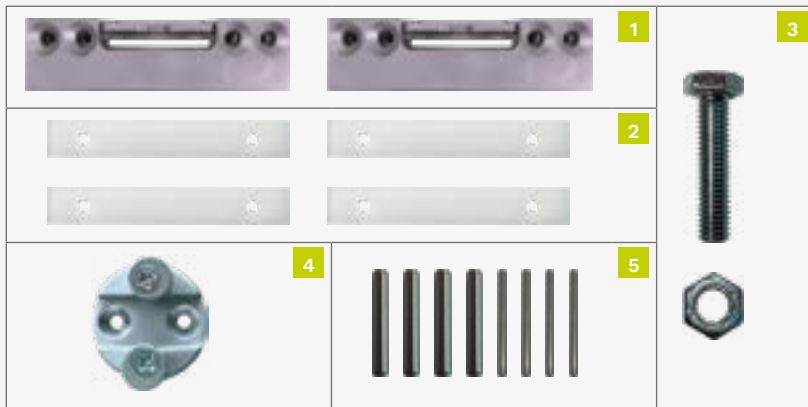

Kit components

1 door set

Item number: 1730 120

Figure	Component	Quantity
1	Glass anchoring clamp	2 pieces
2	Glass seal	4 pieces
3	Roller support screw + nut	2 pieces
4	Adjustable floor guide	1 piece
5	Pins	4 pieces
-	Screws	16 pieces
-	Fork wrench	1 piece



Kit components

1 door set

Item number: 0500 120 1730

Figure	Component	Quantity
1	Upper roller - 120 kg	2 pieces
2	End-stop with adjustable unfasten force	2 pieces

Complete the set in the section "Tracks, floor guide, Accessories and Spare parts".

Technical drawings

Dimensions indicated in millimeters

Solution with item code **0500 120 1730** + item code **1730 120** - load capacity up to 120 kg

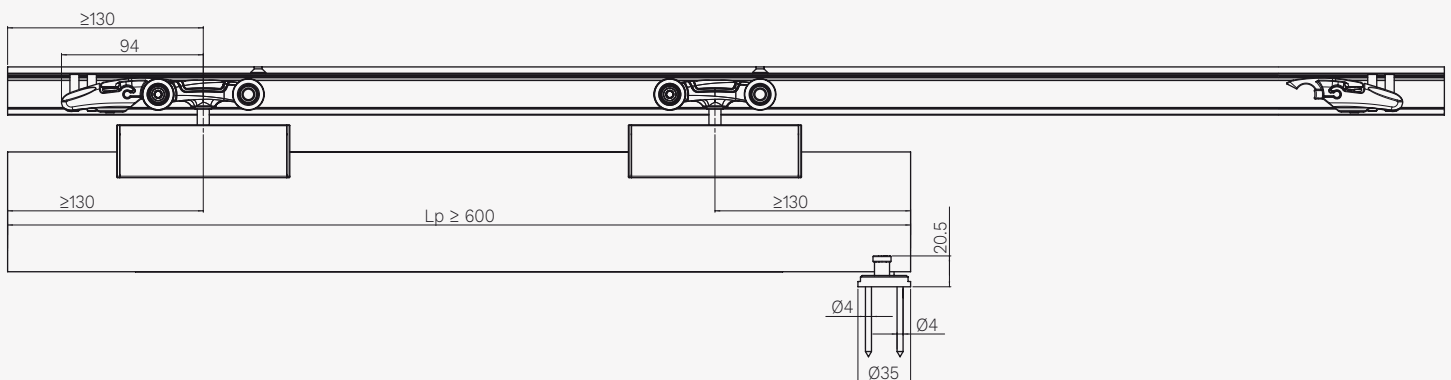

Lp= Door leaf width

SYSTEM 1730 + 0500 120 fixing set for the door and the lower track

Fixing with **glass clamp** and adjustable lower guide

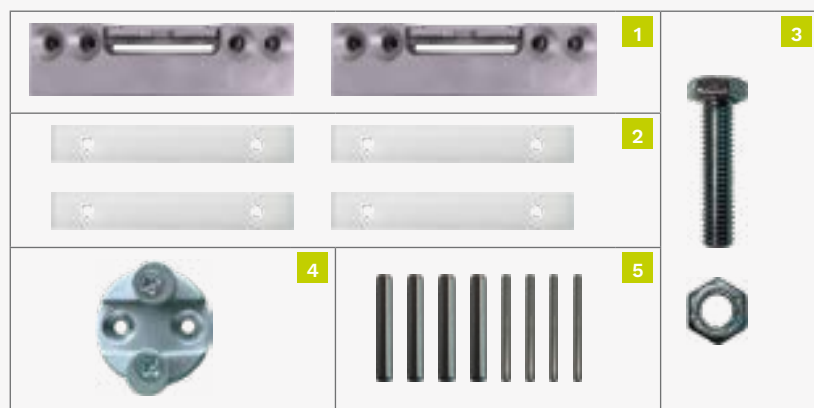

Kit components		
1 door set		
Item number: 1730 120		
Figure	Component	Quantity
1	Glass anchoring clamp	2 pieces
2	Glass seal	4 pieces
3	Roller support screw + nut	2 pieces
4	Adjustable floor guide	1 piece
5	Pins	4 pieces
-	Screws	16 pieces
-	Fork wrench	1 piece



Kit components		
1 door set		
Item number: 0500 120		
Figure	Component	Quantity
1	Upper roller - 120 kg	1 piece
2	Roller with soft close device (double ABS) - 120 kg	1 piece
3	Double ABS door stop	2 pieces
4	Double ABS activator	2 pieces

Complete the set in the section "Tracks, floor guide, Accessories and Spare parts".

Technical drawings

Dimensions indicated in millimeters

Solution with item code **0500 120** + item code **1730 120** - load capacity up to 120 kg

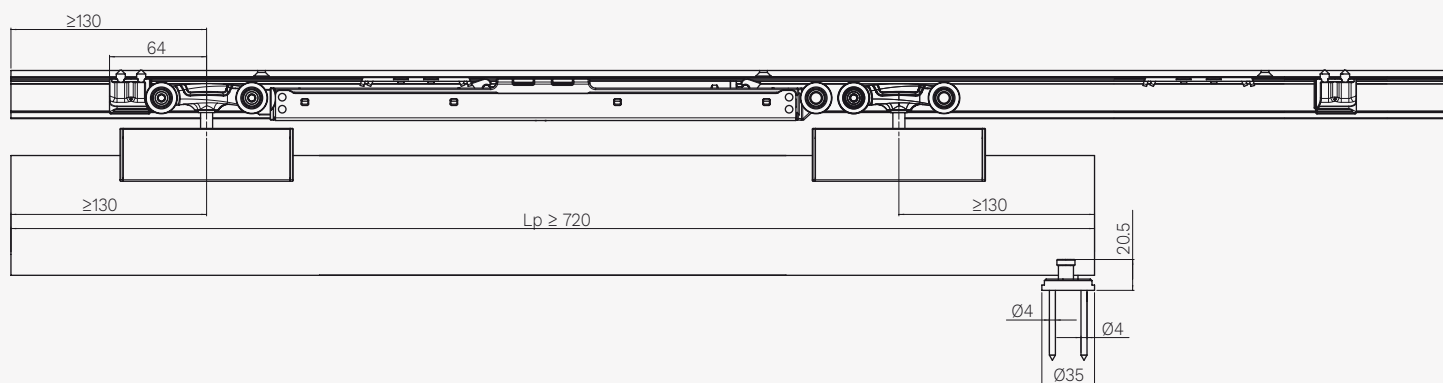

Lp= Door leaf width

Tracks, Accessories and Spare parts 0500 120 1730 / 0500 120

Complete the kit with track and accessory according to application.

Installation examples				Dimensions tracks and accessories	
Dimensions indicated in millimeters and are related to a 120 kg track. You can find the complete dimensions in the mounting instructions.					



Tracks	
Drilled and anodised aluminium track - 120 kg	Item number.
3 meters	0500 10 300
6 meters	0500 10
Drilled and anodised aluminium track - 80 kg (for max. 80 kg door leaf only)	Item number.
1,8 meters	0500 180
2 meters	0500 200
2,4 meters	0500 240
3 meters	0500 300
4 meters	0500 400
6 meters	0500 1

Accessories	
Component	Item number.
Pelmet high cover - 2 meters	0500 A 200
Pelmet high cover - 3 meters	0500 A 300
Pelmet high cover - 4 meters	0500 A 400
Pelmet medium cover - 2 meters	0500 M 200
Pelmet medium cover - 3 meters	0500 M 300
Pelmet medium cover - 4 meters	0500 M 400
Wall fixing - 80 Kg - 2 meters	0500 F 200
Wall fixing - 80 Kg - 3 meters	0500 F 300
Wall fixing - 80 Kg - 4 meters	0500 F 400
Wall fixing - 120 Kg - 3 meters	0500 F 10 300
L shape wall fixing - 80 kg	0500 4
L shape wall fixing - 120 kg	0500 5
Track end cap	0500 61
Pelmet medium end cap	0500 63
Pelmet high end cap	0500 64

Spare parts			
Component	*Quantity	Item number.	Which set is it for?
Upper roller - 120 kg	2 pieces	0500 52	0500 120 1730 / 0500 120
Roller with soft close device (double ABS) - 120 kg	1 piece	0500 120 12 ABS	0500 120
Double ABS door stop	2 pieces		
Double ABS activator	2 pieces	0500 12 60 ABS	0500 120
Double ABS activator	1 piece		
End-stop with adjustable unfasten force	2 pieces	0500 12	0500 120 1730
Fixing plates + screws for hooking profile to a wall	100 pieces	0500 58	0500 120 1730 / 0500 120

*The minimum order quantity is indicated.

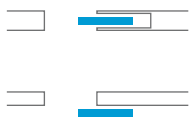
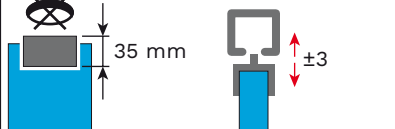
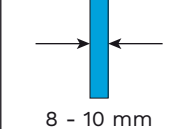
SYSTEM 1730 + 0400

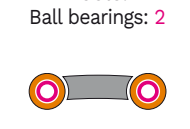
<p>SLIDING Standard</p> 	<p>FIXING Clamp not requiring perforated glass</p> 	<p>DOOR THICKNESS</p> 	<p>DOOR MATERIAL Glass</p> 	<p>SYSTEM LOAD CAPACITY Up to 80 kg</p> 
<p>ROLLERS Body: POM Wheels: 4 Ball bearings: 2</p> 	<p>SOFT-CLOSE</p> <p>ABS ●●●●●●●●</p> <p>SINGLE</p> <p>Type: Mechanic Covering: Plastic</p>			

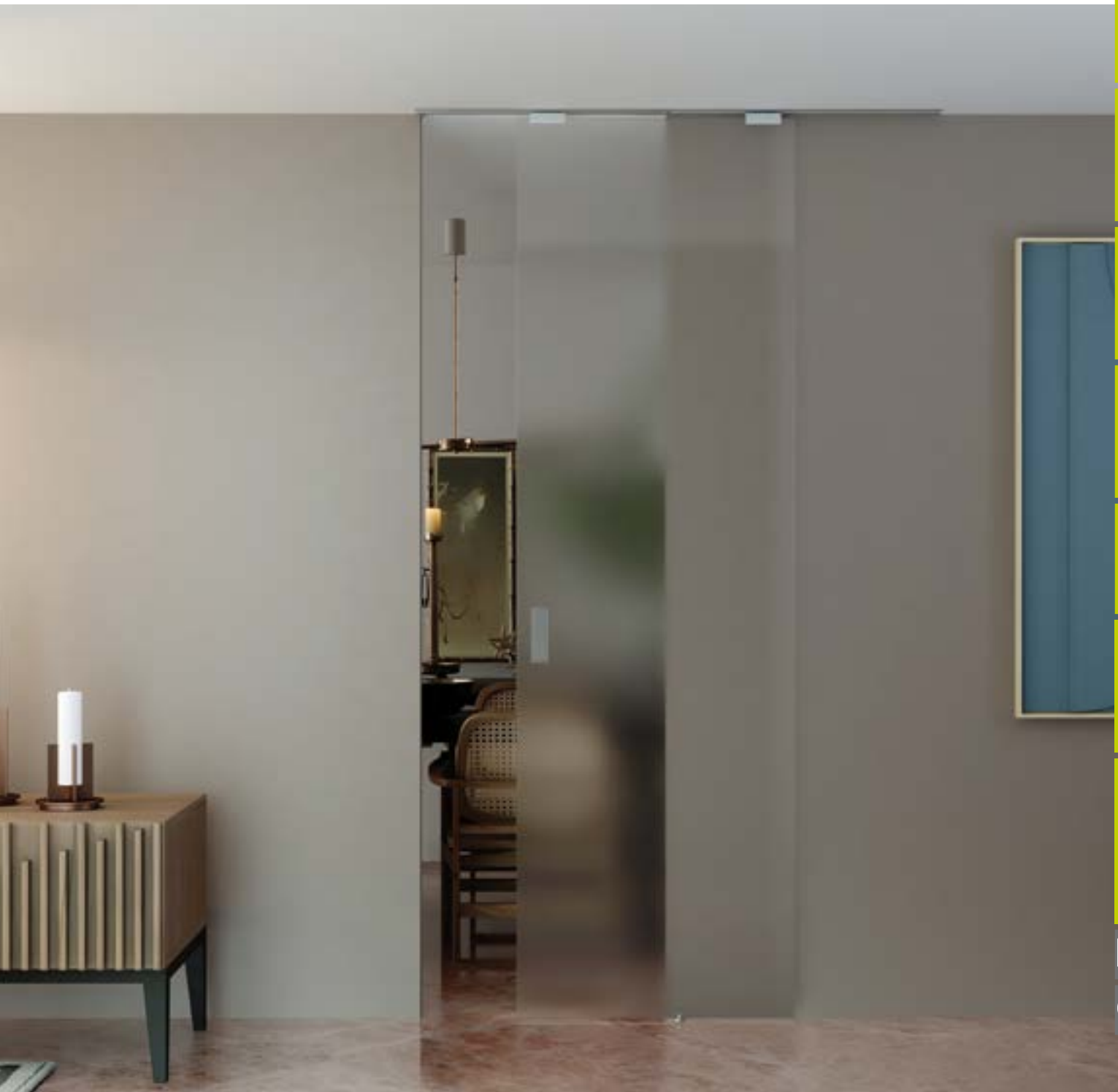

SYSTEM 1730 + 0400 3 1730 fixing set for the door and the lower track

Fixing with **glass clamp** and adjustable lower guide



Kit components

1 door set

Item number: 1730 120

Figure	Component	Quantity
1	Glass anchoring clamp	2 pieces
2	Glass seal	4 pieces
3	Roller support screw + nut	2 pieces
4	Adjustable floor guide	1 piece
5	Pins	4 pieces
-	Screws	16 pieces
-	Fork wrench	1 piece



Kit components

1 door set

Item number: 0400 3 1730

Figure	Component	Quantity
1	Upper roller - 40 kg	2 pieces
2	End-stop	2 pieces

Complete the set in the section "Tracks, floor guide, Accessories and Spare parts".

Technical drawings

Dimensions indicated in millimeters

Solution with item code **0400 3 1730** + item code **1730 120** - load capacity up to 40 kg

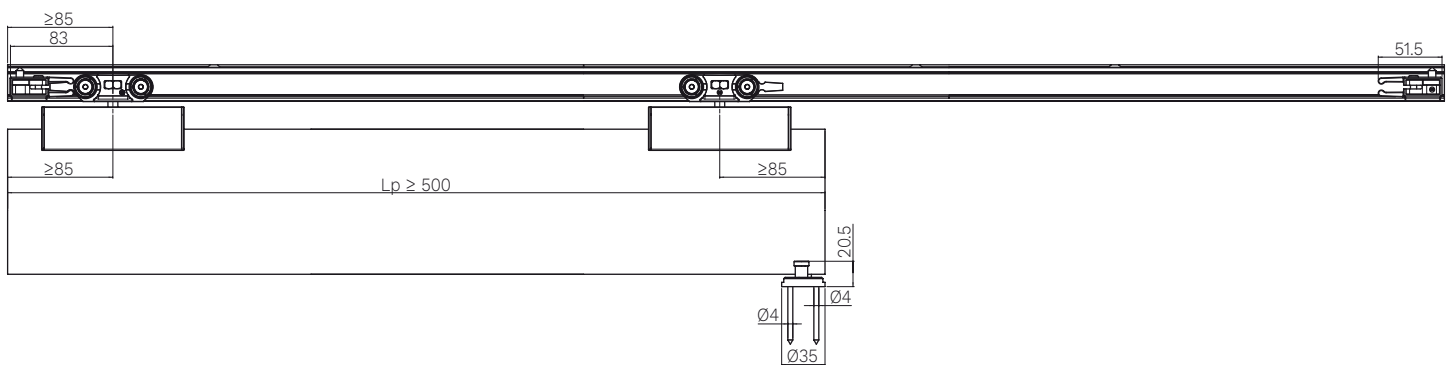

Lp= Door leaf width

Tracks, Accessories and Spare parts 0400 3 1730

Complete the kit with track and accessory according to application.

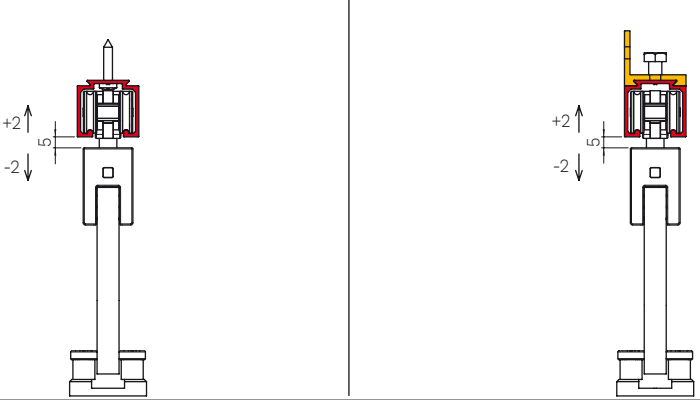
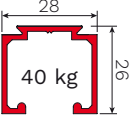
Installation examples	Dimensions tracks and accessories
<p>Dimensions indicated in millimeters</p> 	

Tracks	
Drilled and anodised aluminium track - 40 kg	Item number.
2 meters	0400 1 200
3 meters	0400 6
4 meters	0400 1 400
6 meters	0400 1
Raw aluminum track drilled - 40 kg	Item number.
3 meters	0400 6G
6 meters	0400 1G

Accessories	
Component	Item number.
L shape wall fixing - 40 kg	0400 5

Spare parts			
Component	*Quantity	Item number.	Which set is it for?
Upper roller - 40 kg	2 pieces	0400 54	0400 3 1730
Single-entry bracket	2 pieces	0400 53	0400 3 1730
Support screw for roller (hanger)	2 pieces	0400 51	0400 3 1730
Adjustable lower guide	20 pieces	0810 80x800	0400 3 1730
End-stop	2 pieces	0400 52	0400 3 1730

*The minimum order quantity is indicated.

SYSTEM 1730 + 0400 4 1730 fixing set for the door and the lower track

Fixing with **glass clamp** and adjustable lower guide



Kit components

1 door set

Item number: 1730 120

Figure	Component	Quantity
1	Glass anchoring clamp	2 pieces
2	Glass seal	4 pieces
3	Roller support screw + nut	2 pieces
4	Adjustable floor guide	1 piece
5	Pins	4 pieces
-	Screws	16 pieces
-	Fork wrench	1 piece



Kit components

1 door set

Item number: 0400 4 1730

Figure	Component	Quantity
1	Upper roller - 80 kg	2 pieces
2	End-stop	2 pieces

Complete the set in the section "Tracks, floor guide, Accessories and Spare parts".

Technical drawings

Dimensions indicated in millimeters

Solution with item code **0400 4 1730** + item code **1730 120** - load capacity up to 80 kg

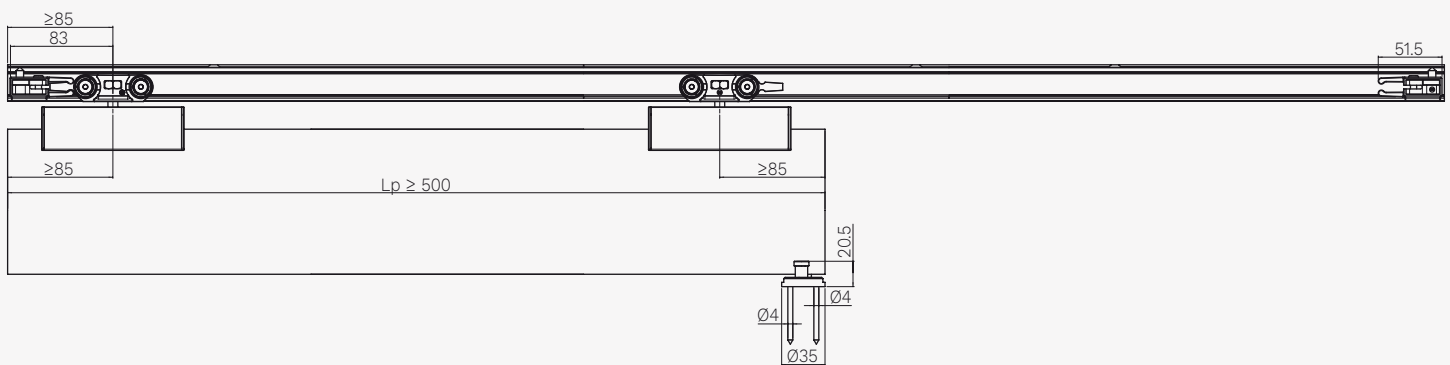

Lp= Door leaf width

SYSTEM 1730 + 0400 4 1730 ABS fixing set for the door and the lower track

Fixing with **glass clamp** and adjustable lower guide

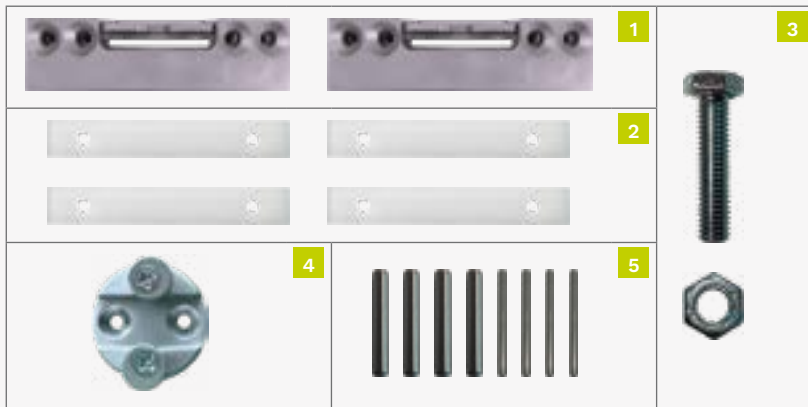

Kit components

1 door set

Item number: 1730 120

Figure	Component	Quantity
1	Glass anchoring clamp	2 pieces
2	Glass seal	4 pieces
3	Roller support screw + nut	2 pieces
4	Adjustable floor guide	1 piece
5	Pins	4 pieces
-	Screws	16 pieces
-	Fork wrench	1 piece



Kit components

1 door set

Item number: 0400 4 1730 ABS

Figure	Component	Quantity
1	Upper roller - 80 kg	2 pieces
2	Soft close device (single ABS) - 60 kg	2 pieces
3	Single ABS activator	2 pieces

Complete the set in the section "Tracks, floor guide, Accessories and Spare parts".

Technical drawings

Dimensions indicated in millimeters

Solution with item code **0400 4 1730 ABS** + item code **1730 120** - load capacity up to 60 kg

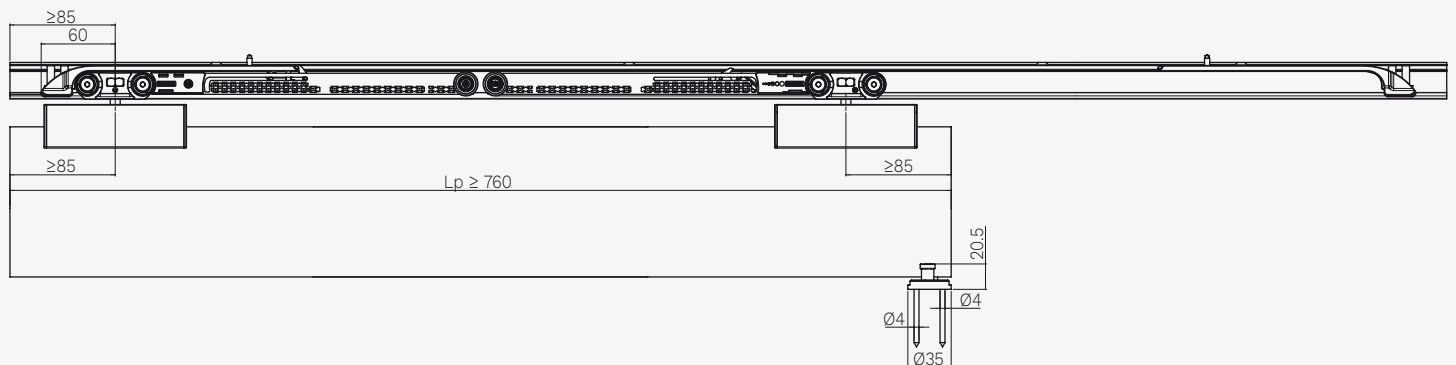

Lp= Door leaf width

Tracks, Accessories and Spare parts 0400 4 1730 / 0400 4 1730 ABS

Complete the kit with track and accessory according to application.

Installation examples	Dimensions tracks and accessories
<p>Dimensions indicated in millimeters</p>	

Tracks	
Drilled and anodised aluminium track - 80 kg	Item number.
2 meters	0400 2 200
3 meters	0400 7
4 meters	0400 2 400
6 meters	0400 2

Accessories	
Component	Item number.
Pelmet medium cover - 2 meters	0500 M 200
Pelmet medium cover - 3 meters	0500 M 300
Pelmet medium cover - 4 meters	0500 M 400
Pelmet high cover - 2 meters	0500 A 200
Pelmet high cover - 3 meters	0500 A 300
Pelmet high cover - 4 meters	0500 A 400
Wall fixing - 80 Kg - 2 meters	0500 F 200
Wall fixing - 80 Kg - 3 meters	0500 F 300
Wall fixing - 80 Kg - 4 meters	0500 F 400
L shape wall fixing - 80 kg	0500 4
Track end cap	0500 61
Pelmet medium end cap	0500 63
Pelmet high end cap	0500 64

Spare parts			
Component	*Quantity	Item number.	Which set is it for?
Upper roller - 80 kg	2 pieces	0400 55	0400 4 1730 / 0400 4 1730 ABS
End-stop	2 pieces	0400 52	0400 4 1730
Soft close device (single ABS) - 60 kg	1 piece	0400 ABS	0400 4 1730 ABS
Single ABS activator	1 piece	0400 52 ABS	0400 4 1730 ABS
Fixing plates + screws for hooking profile to a wall 0500 F	100 pieces	0500 58	0400 4 1730 / 0400 4 1730 ABS

*The minimum order quantity is indicated.

BASIC SERIES





Sliding systems for wooden,
metal and PVC doors

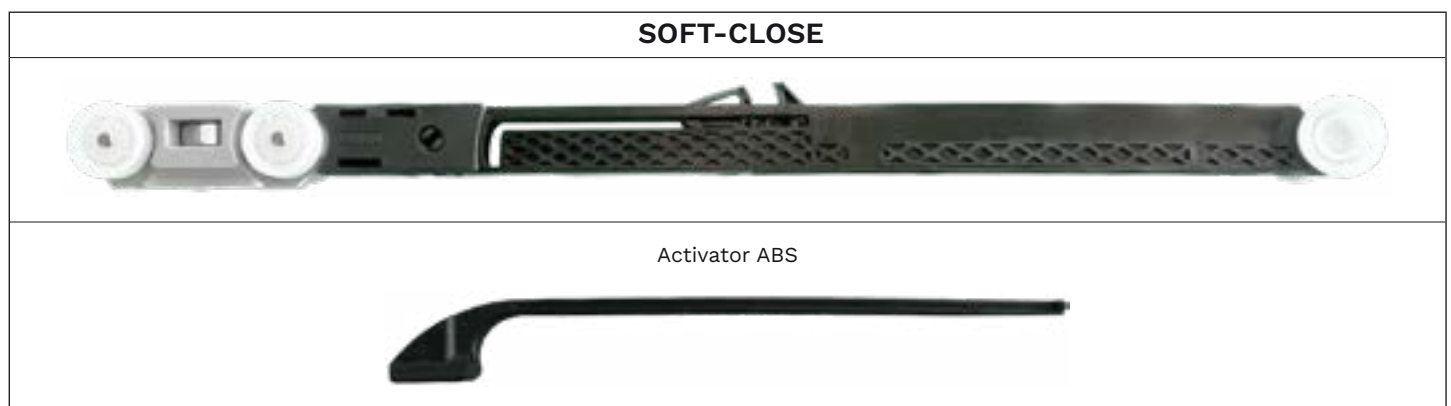
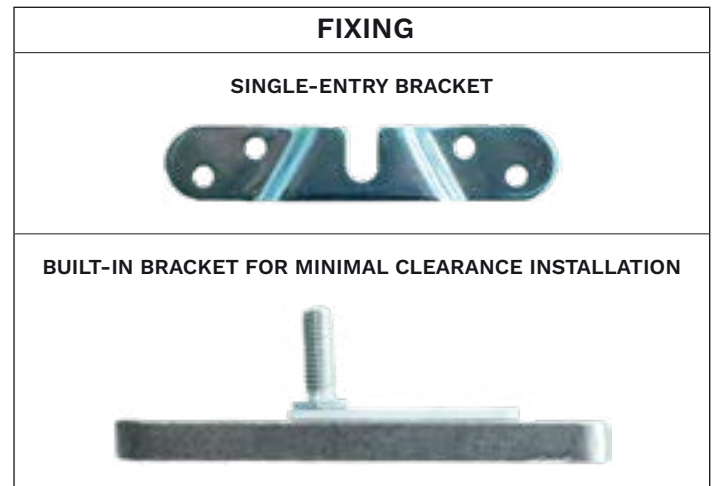

FEATURES:

1. **ROLLER** made of **POM** (Polyoxymethylene) **body** and **wheels**. The 80 Kg version has a ball bearing per couple of wheels, in order to guarantee a better smoothness and fluidity.
2. **SOFT CLOSE DEVICE** for soft opening or closing. The body made of POM is integrated in the track.
3. **FIXING**
 - **SINGLE-ENTRY BRACKET** for door leaf hanging.
 - **BUILT-IN BRACKET** for minimal clearance installation.
4. **END-STOP**.
5. **ADJUSTABLE FLOOR GUIDE**, the buttonholes allow to adjust the guide positioning.



System	Door material	Sliding	Fixing	Page
0400		Standard 	Standard single-entry bracket	82
0450		Standard 	Bracket for minimal clearance installation	100

TERMS AND DEFINITIONS

• **DOOR MATERIAL**



Wood



Metal



PVC

• **SLIDING**



Standard

The solution that allows the creation of pocket and wall mounted sliding doors. It can be made with a **usual bracket** fixed in the upper part of the door or **embedded** in the door leaf when applied as flush to upper track.

• **WOOD FIXING**

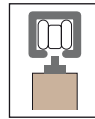

Standard single-entry bracket

An anchor bracket fixed in the upper part of the door leaf.

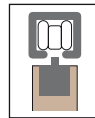

Bracket for minimal clearance installation



A bracket embedded into the panel to make the sliding door flush to the upper track.

• **SOFT-CLOSE**



Soft close device for soft opening or closing. The body made of POM is integrated in the track.

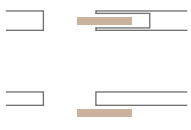
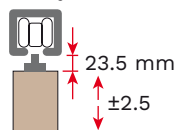
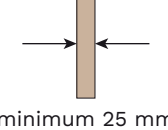
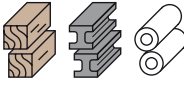







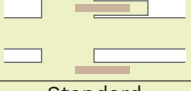

SYSTEM BASIC 0400

<p>SLIDING Standard</p> 	<p>FIXING Standard single-entry bracket</p> 	<p>DOOR THICKNESS</p>  <p>minimum 25 mm</p>	<p>DOOR MATERIAL Wood, Metal and PVC</p> 	<p>SYSTEM LOAD CAPACITY Up to 80 kg</p> 	<p>ROLLERS Body: POM Wheels: 4 Ball bearings: 2</p> 
<p>SOFT-CLOSE</p> <p>ABS ●●●●●●</p> <p>SINGLE</p> <p>Type: Mechanic Covering: Plastic</p>					

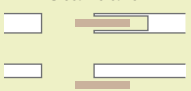

INDEX

A sliding set for Basic system 0400

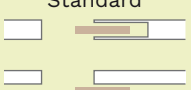
Set	Load capacity	Door thickness	Sliding	Soft-close	Track	Page
0400 3	40 kg	minimum 25 mm	Standard 	No	4 lengths available	84
Tracks, Accessories and Spare parts 0400 3						85
0400 4	80 kg	minimum 25 mm	Standard 	No	4 lengths available	86
0400 4 1ABS	60 kg	minimum 25 mm	Standard 	Yes	4 lengths available	87
0400 4 2ABS	60 kg	minimum 25 mm	Standard 	Yes	4 lengths available	88
Tracks, Accessories and Spare parts 0400 4 / 0400 4 1ABS / 0400 4 2ABS						89
040040 160	40 kg	minimum 25 mm	Standard 	No	1,6 meters	90
040040 200	40 kg	minimum 25 mm	Standard 	No	2 meters	91
040040 230	40 kg	minimum 25 mm	Standard 	No	2,3 meters	92
040040 300	40 kg	minimum 25 mm	Standard 	No	3 meters	93
Tracks, Accessories and Spare parts 040040 160 / 040040 200 / 040040 230 / 040040 300						94
040080 150	80 kg	minimum 25 mm	Standard 	No	1,5 meters	95
040080 200	80 kg	minimum 25 mm	Standard 	No	2 meters	96
040080 230	80 kg	minimum 25 mm	Standard 	No	2,3 meters	97
040080 300	80 kg	minimum 25 mm	Standard 	No	3 meters	98
Tracks, Accessories and Spare parts 040080 150 / 040080 200 / 040080 230 / 040080 300						99

Optional

System	Description	Item number.	Page
New Kit Klose	Self closing - outside the wall	0880 1	149
	Self closing - inside the wall	0880 2	150
2000	Parallel door sliding gear	2000	152

KIT 0400 3

Standard sliding door kit. POM roller, single-entry bracket, end stop. Load capacity 40 kg.

<p>SLIDING Standard</p>	<p>FIXING Standard single-entry bracket</p>	<p>DOOR THICKNESS</p> <p>minimum 25 mm</p>	<p>DOOR MATERIAL Wood, Metal and PVC</p>	<p>SYSTEM LOAD CAPACITY Up to 40 kg</p>	<p>ROLLERS Body: POM Wheels: 4</p>
------------------------------------	--	---	---	--	---

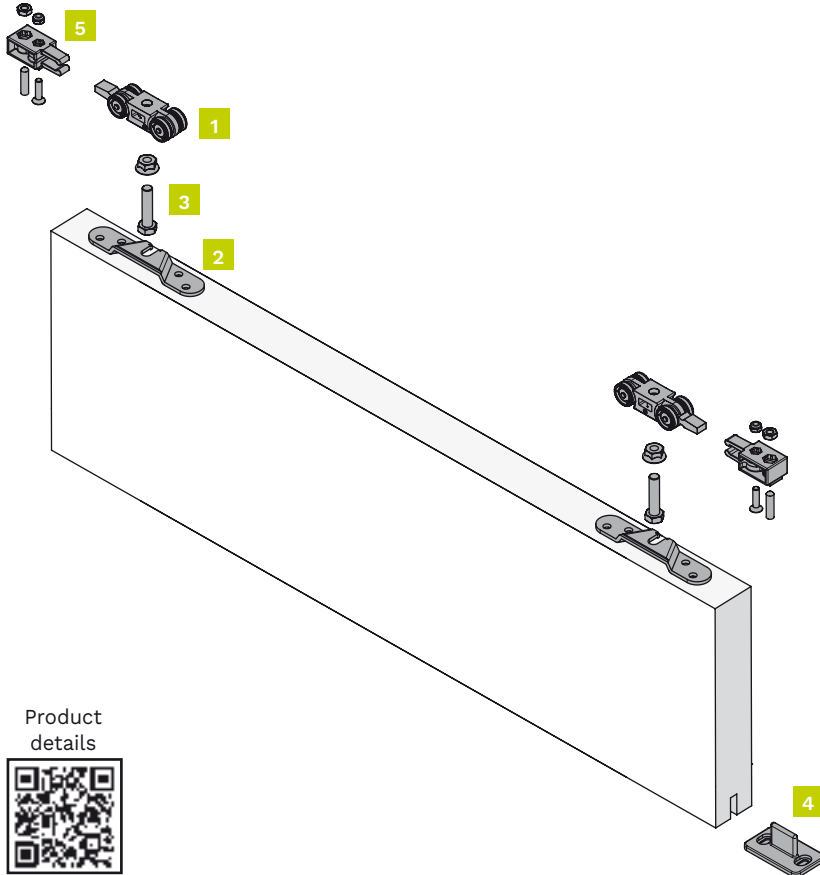

Kit components

1 door set

Item number: 0400 3

Figure	Component	Quantity
1	Upper roller - 40 kg	2 pieces
2	Single-entry bracket	2 pieces
3	Support screw for roller (hanger)	2 pieces
4	Adjustable lower guide	1 piece
5	End-stop	2 pieces

Complete the set in the section "Tracks, Accessories and Spare parts".

Technical drawings

Dimensions indicated in millimeters

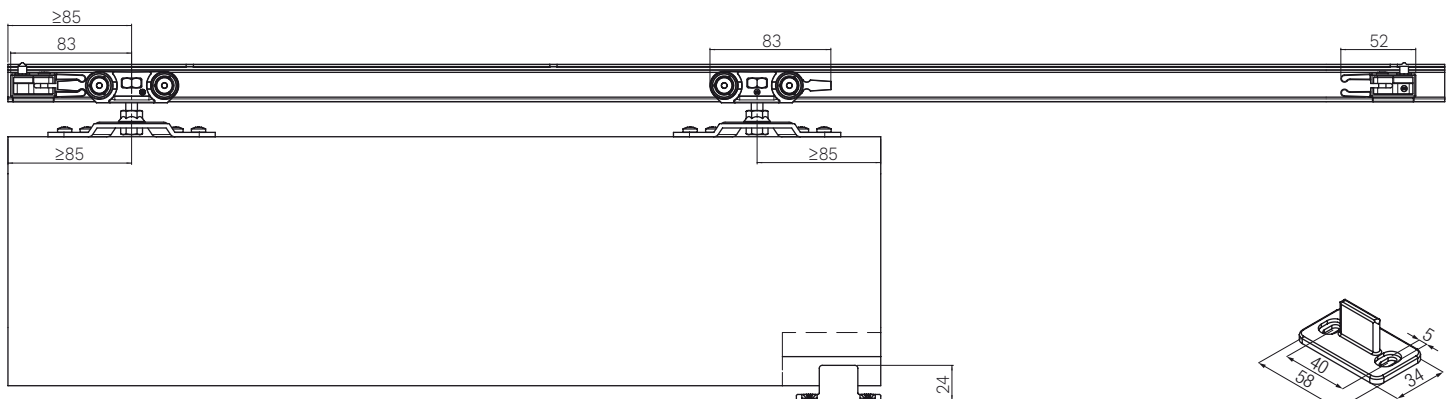

Tracks, Accessories and Spare parts 0400 3

Complete the kit with track and accessory according to application.

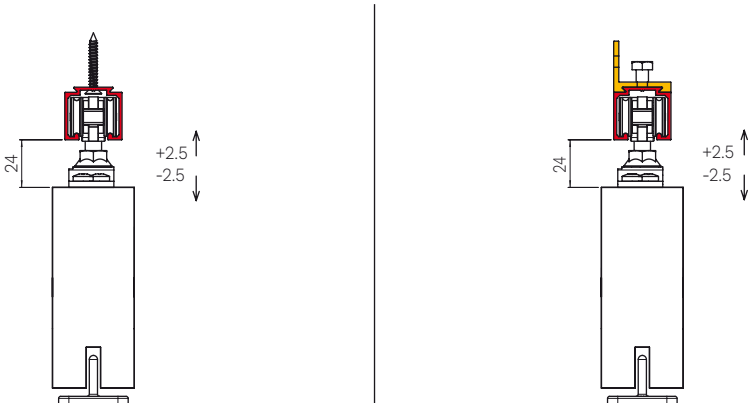
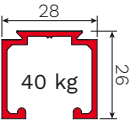
Installation examples	Dimensions tracks and accessories
<p>Dimensions indicated in millimeters</p> 	

Tracks	
Drilled and anodised aluminium track - 40 kg	Item number.
2 meters	0400 1 200
3 meters	0400 6
4 meters	0400 1 400
6 meters	0400 1
Raw aluminum track drilled - 40 kg	Item number.
3 meters	0400 6G
6 meters	0400 1G

Accessories	
Component	Item number.
L shape wall fixing - 40 kg	0400 5

Spare parts			
Component	*Quantity	Item number.	Which set is it for?
Upper roller - 40 kg	2 pieces	0400 54	0400 3
Single-entry bracket	2 pieces	0400 53	0400 3
Support screw for roller (hanger)	2 pieces	0400 51	0400 3
Adjustable lower guide	20 pieces	0810 80x800	0400 3
End-stop	2 pieces	0400 52	0400 3

*The minimum order quantity is indicated.

KIT 0400 4

Standard sliding door kit. POM roller, single-entry bracket, end stop. Load capacity 80 kg.

<p>SLIDING Standard</p>	<p>FIXING Standard single-entry bracket</p>	<p>DOOR THICKNESS</p> <p>minimum 25 mm</p>	<p>DOOR MATERIAL Wood, Metal and PVC</p>	<p>SYSTEM LOAD CAPACITY Up to 80 kg</p>	<p>ROLLERS Body: POM Wheels: 4 Ball bearings: 2</p>
------------------------------------	--	---	---	--	--

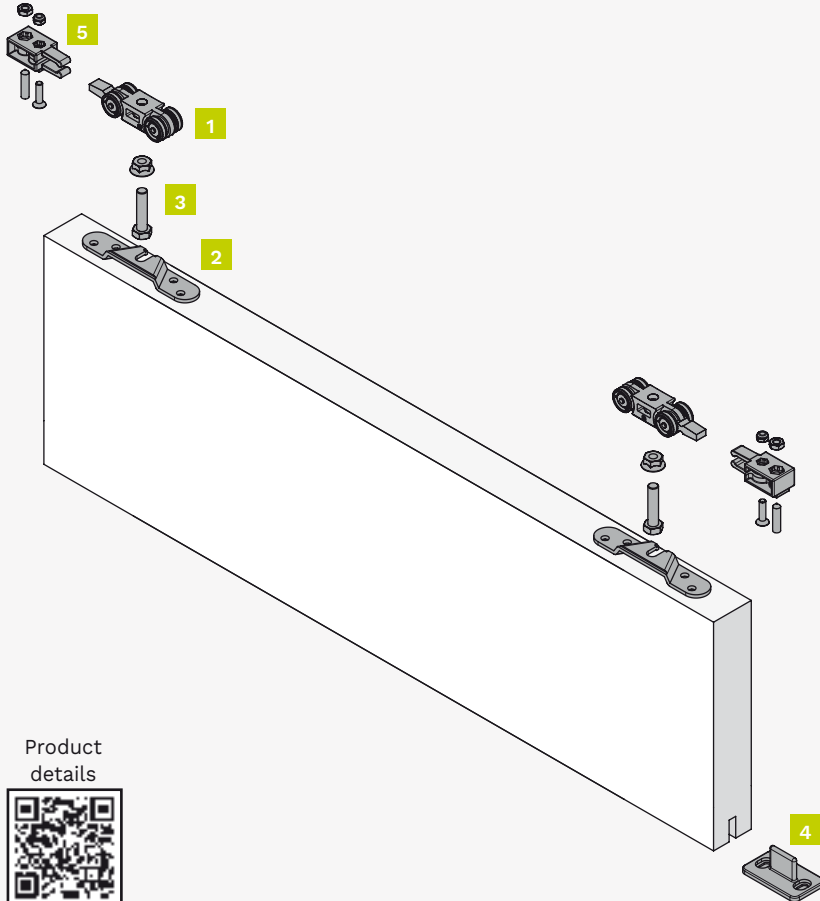

Kit components

1 door set

Item number: 0400 4

Figure	Component	Quantity
1	Upper roller - 80 kg	2 pieces
2	Single-entry bracket	2 pieces
3	Support screw for roller (hanger)	2 pieces
4	Adjustable lower guide	1 piece
5	End-stop	2 pieces

Complete the set in the section "Tracks, Accessories and Spare parts".

Product details



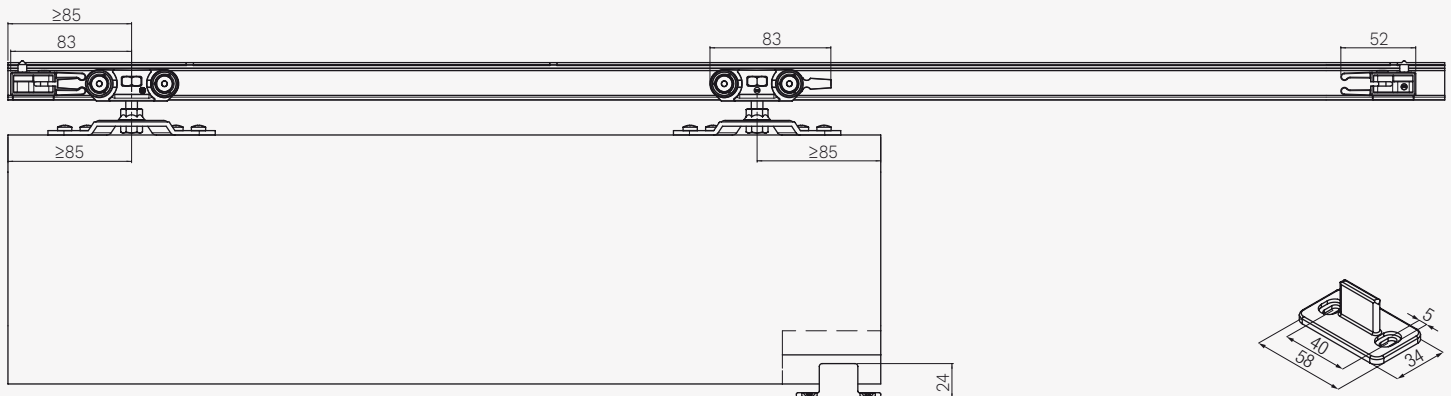

Technical drawings

Dimensions indicated in millimeters

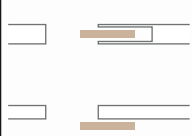
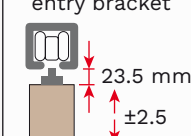
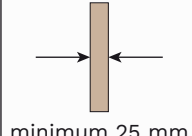
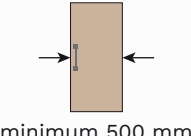
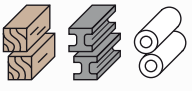

KIT 0400 4 1ABS

Standard sliding door kit. POM roller, single-entry bracket, end stop, single ABS soft closing. Load capacity 60 kg.

SLIDING Standard 	FIXING Standard single-entry bracket 	DOOR THICKNESS  minimum 25 mm	DOOR LEAF WIDTH  minimum 500 mm	DOOR MATERIAL Wood, Metal and PVC 	SYSTEM LOAD CAPACITY Up to 60 kg 	ROLLERS Body: POM Wheels: 4 Ball bearings: 2 
--	---	---	---	---	---	---

SOFT-CLOSE

ABS ●●●●●●●●

SINGLE

Type: Mechanic
Covering: Plastic

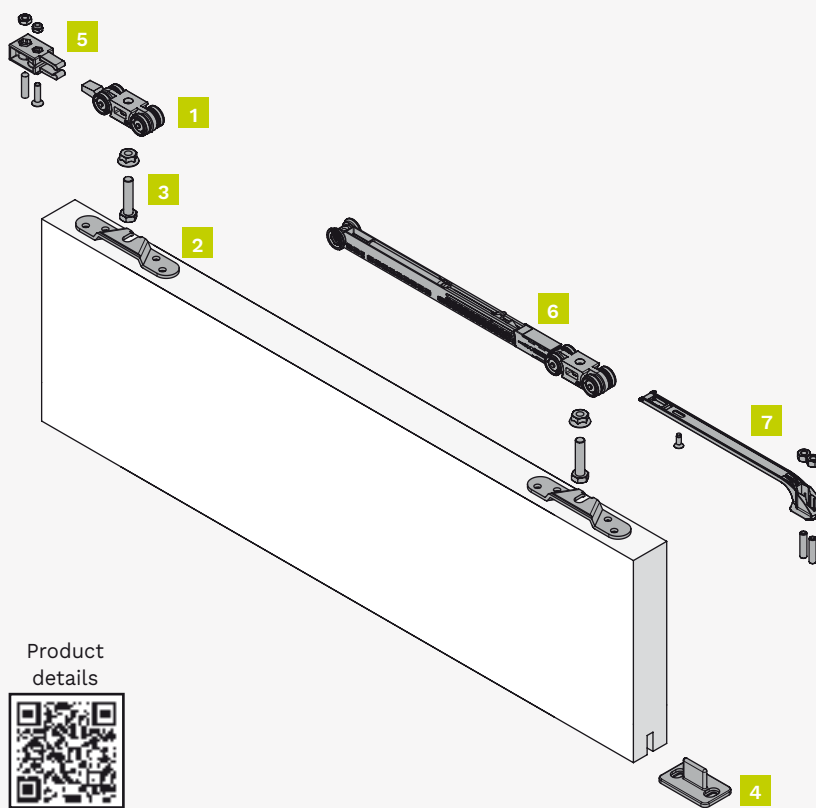

Kit components

1 door set
Item number: 0400 4 1ABS

Figure	Component	Quantity
1	Upper roller - 80 kg	2 pieces
2	Single-entry bracket	2 pieces
3	Support screw for roller (hanger)	2 pieces
4	Adjustable lower guide	1 piece
5	End-stop	1 piece
6	Soft close device (single ABS) - 60 kg	1 piece
7	Single ABS activator	1 piece

Complete the set in the section "Tracks, Accessories and Spare parts".

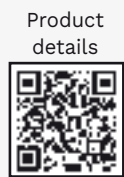

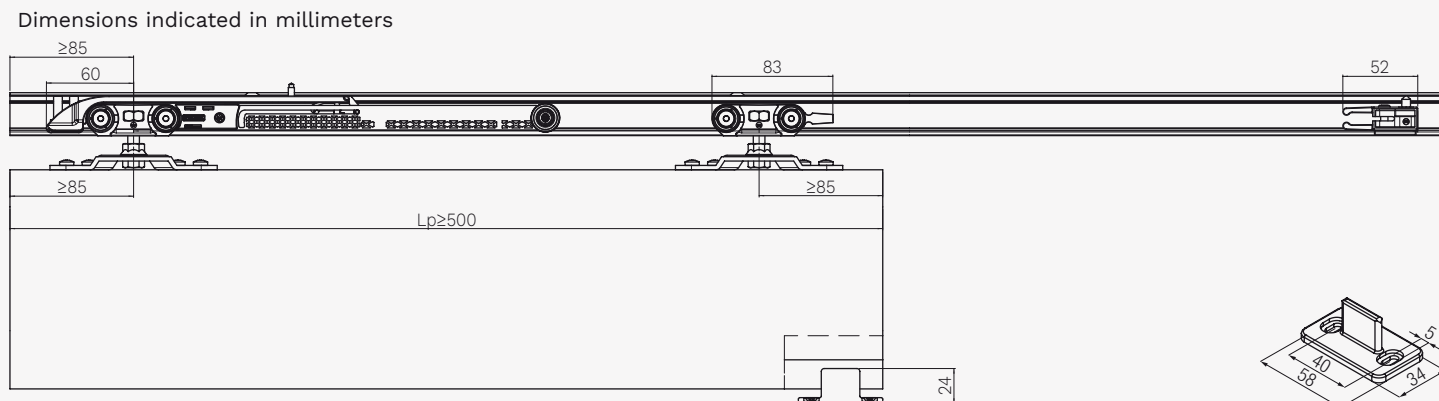

Technical drawings



Lp= Door leaf width

KIT 0400 4 2ABS

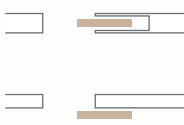
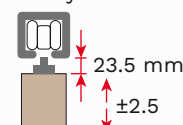
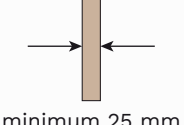
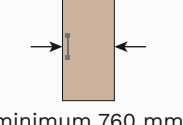
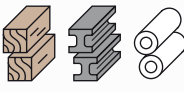
Standard sliding door kit. POM roller, single-entry bracket, two single ABS soft closing. Load capacity 60 kg.

SLIDING Standard 	FIXING Standard single-entry bracket  23.5 mm ± 2.5	DOOR THICKNESS  minimum 25 mm	DOOR LEAF WIDTH  minimum 760 mm	DOOR MATERIAL Wood, Metal and PVC 	SYSTEM LOAD CAPACITY Up to 60 kg 	ROLLERS Body: POM Wheels: 4 Ball bearings: 2 
--	---	---	---	---	---	---

SOFT-CLOSE

ABS ●●●●●●●●

SINGLE

Type: Mechanic
Covering: Plastic

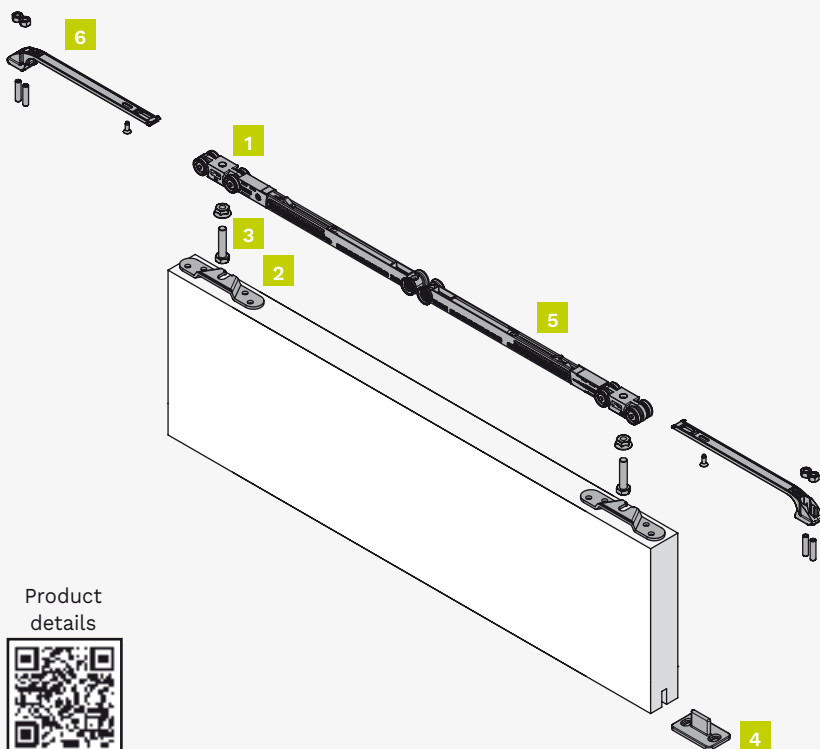

Kit components

1 door set
Item number: 0400 4 2ABS

Figure	Component	Quantity
1	Upper roller - 80 kg	2 pieces
2	Single-entry bracket	2 pieces
3	Support screw for roller (hanger)	2 pieces
4	Adjustable lower guide	1 piece
5	Soft close device (single ABS) - 60 kg	2 pieces
6	Single ABS activator	2 pieces

Complete the set in the section "Tracks, Accessories and Spare parts".

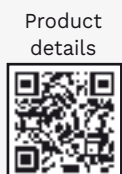

Technical drawings

Dimensions indicated in millimeters

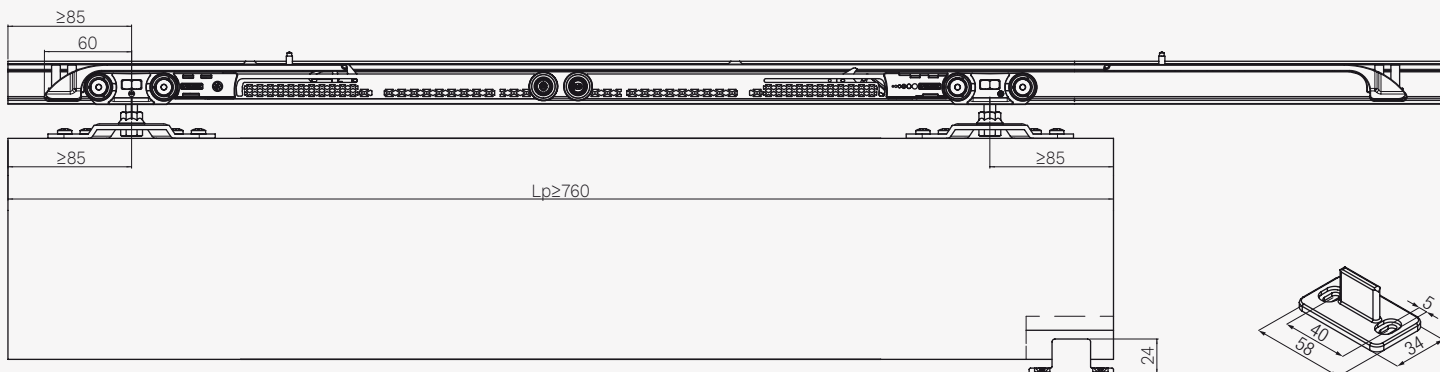

Lp= Door leaf width

Tracks, Accessories and Spare parts 0400 4 / 0400 4 1ABS / 0400 4 2ABS

Complete the kit with track and accessory according to application.

Installation examples			Dimensions tracks and accessories	
Dimensions indicated in millimeters				

Tracks

Drilled and anodised aluminium track - 80 kg	Item number.
2 meters	0400 2 200
3 meters	0400 7
4 meters	0400 2 400
6 meters	0400 2

Accessories

Component	Item number.
Pelmet medium cover - 2 meters	0500 M 200
Pelmet medium cover - 3 meters	0500 M 300
Pelmet medium cover - 4 meters	0500 M 400
Pelmet high cover - 2 meters	0500 A 200
Pelmet high cover - 3 meters	0500 A 300
Pelmet high cover - 4 meters	0500 A 400
Wall fixing - 80 Kg - 2 meters	0500 F 200
Wall fixing - 80 Kg - 3 meters	0500 F 300
Wall fixing - 80 Kg - 4 meters	0500 F 400
L shape wall fixing - 80 kg	0500 4
Track end cap	0500 61
Pelmet medium end cap	0500 63
Pelmet high end cap	0500 64





Spare parts

Component	*Quantity	Item number.	Which set is it for?
Upper roller - 80 kg	2 pieces	0400 55	0400 4 / 0400 4 1ABS / 0400 4 2ABS
Single-entry bracket	2 pieces	0400 53	0400 4 / 0400 4 1ABS / 0400 4 2ABS
Support screw for roller (hanger)	2 pieces	0400 51	0400 4 / 0400 4 1ABS / 0400 4 2ABS
Adjustable lower guide	20 pieces	0810 80x800	0400 4 / 0400 4 1ABS / 0400 4 2ABS
End-stop	2 pieces	0400 52	0400 4 / 0400 4 1ABS
Soft close device (single ABS) - 60 kg	1 piece	0400 ABS	0400 4 1ABS / 0400 4 2ABS
Single ABS activator	1 piece	0400 52 ABS	0400 4 1ABS / 0400 4 2ABS
Fixing plates + screws for hooking profile to a wall 0500 F	100 pieces	0500 58	0400 4 / 0400 4 1ABS / 0400 4 2ABS

*The minimum order quantity is indicated.

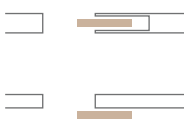
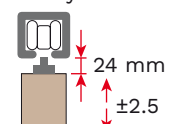
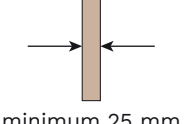
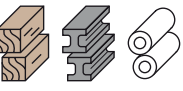
KIT 040040 160

Standard sliding door kit with a 1,6-meter track. POM roller, single-entry bracket, end stop. Load capacity 40 kg.

SLIDING Standard 	FIXING Standard single-entry bracket  24 mm ± 2.5	DOOR THICKNESS  minimum 25 mm	DOOR MATERIAL Wood, Metal and PVC 	SYSTEM LOAD CAPACITY Up to 40 kg 	ROLLERS Body: POM Wheels: 4 	INCLUDED IN THE KIT Track  1600 mm
--	---	---	--	--	---	---

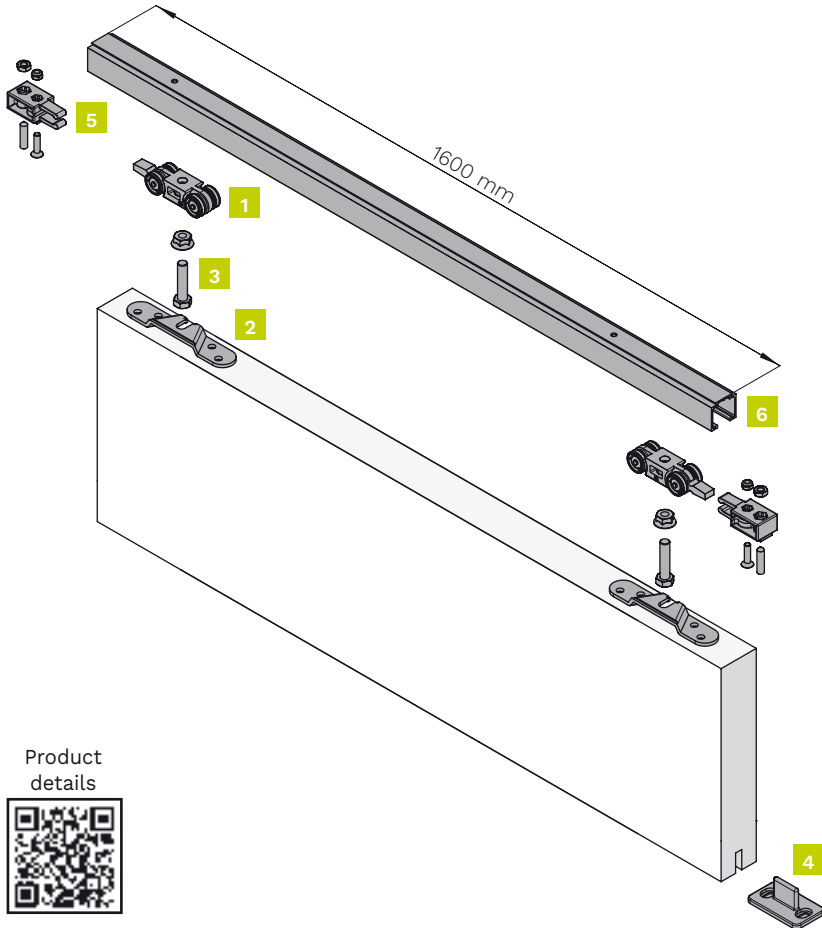

Kit components

1 door set
Item number: 040040 160

Figure	Component	Quantity
1	Upper roller - 40 kg	2 pieces
2	Single-entry bracket	2 pieces
3	Support screw for roller (hanger)	2 pieces
4	Adjustable lower guide	1 piece
5	End-stop	2 pieces
6	Track 1,6 meters	1 piece

Complete the set in the section "Tracks, Accessories and Spare parts".



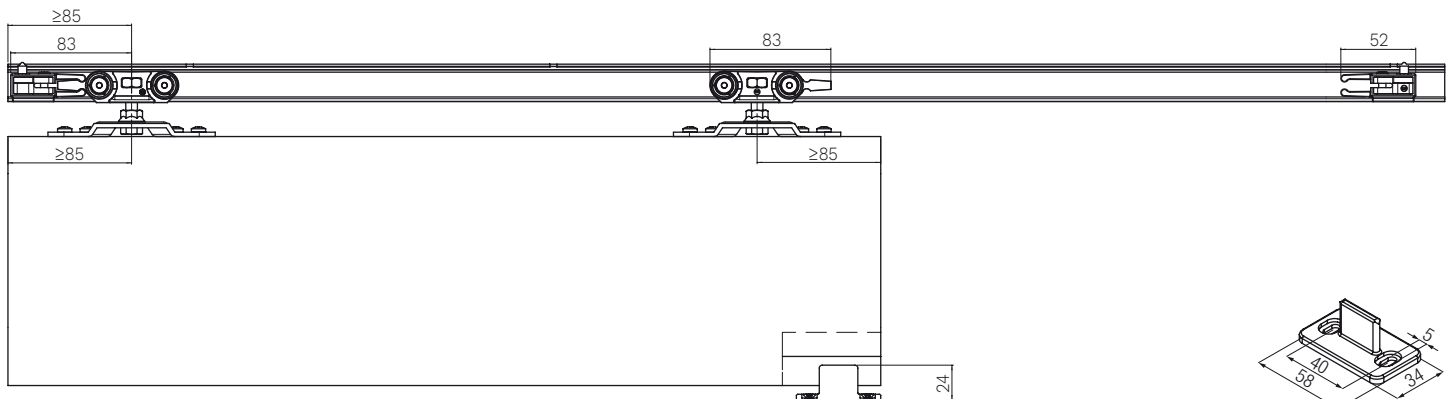

Technical drawings

Dimensions indicated in millimeters

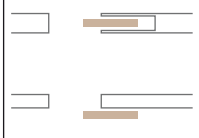
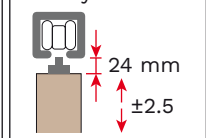
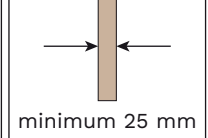
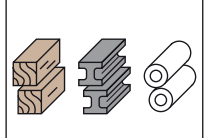

KIT 040040 200

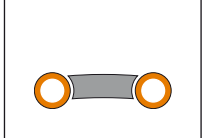
Standard sliding door kit with a 2-meter track. POM roller, single-entry bracket, end stop. Load capacity 40 kg.

<p>SLIDING Standard</p> 	<p>FIXING Standard single-entry bracket</p> 	<p>DOOR THICKNESS</p> 	<p>DOOR MATERIAL Wood, Metal and PVC</p> 	<p>SYSTEM LOAD CAPACITY Up to 40 kg</p> 	<p>ROLLERS Body: POM Wheels: 4</p> 	<p>INCLUDED IN THE KIT Track</p> 
---	--	--	---	---	---	---

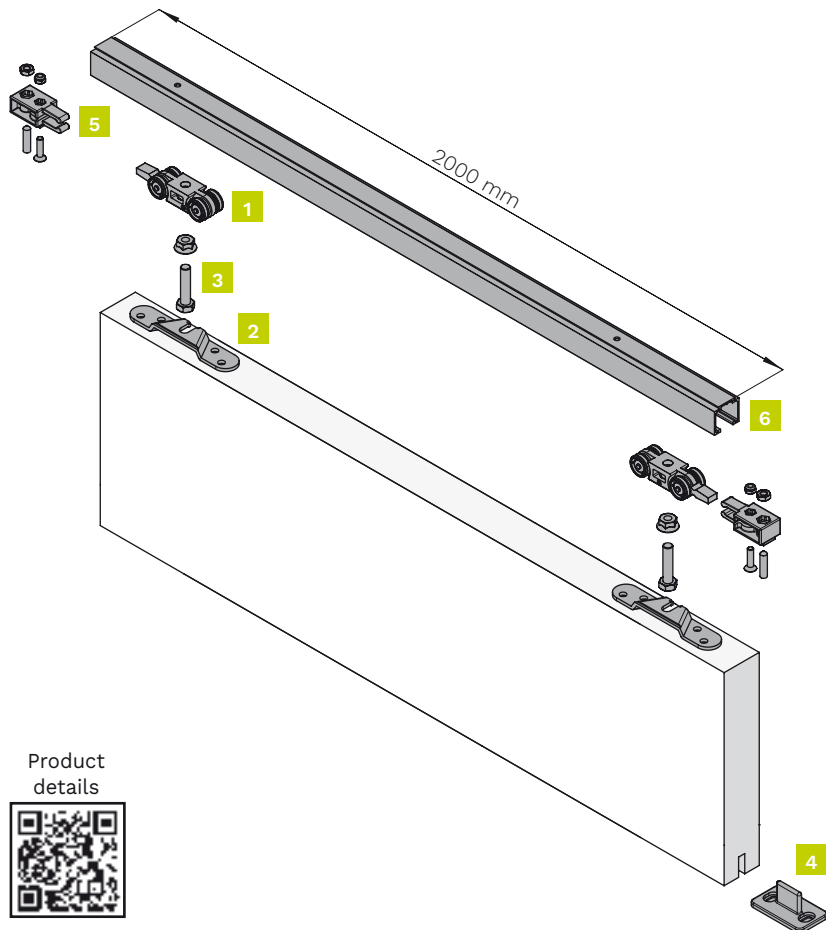

Kit components

1 door set

Item number: 040040 200

Figure	Component	Quantity
1	Upper roller - 40 kg	2 pieces
2	Single-entry bracket	2 pieces
3	Support screw for roller (hanger)	2 pieces
4	Adjustable lower guide	1 piece
5	End-stop	2 pieces
6	Track 2 meters	1 piece

Complete the set in the section "Tracks, Accessories and Spare parts".

Product details





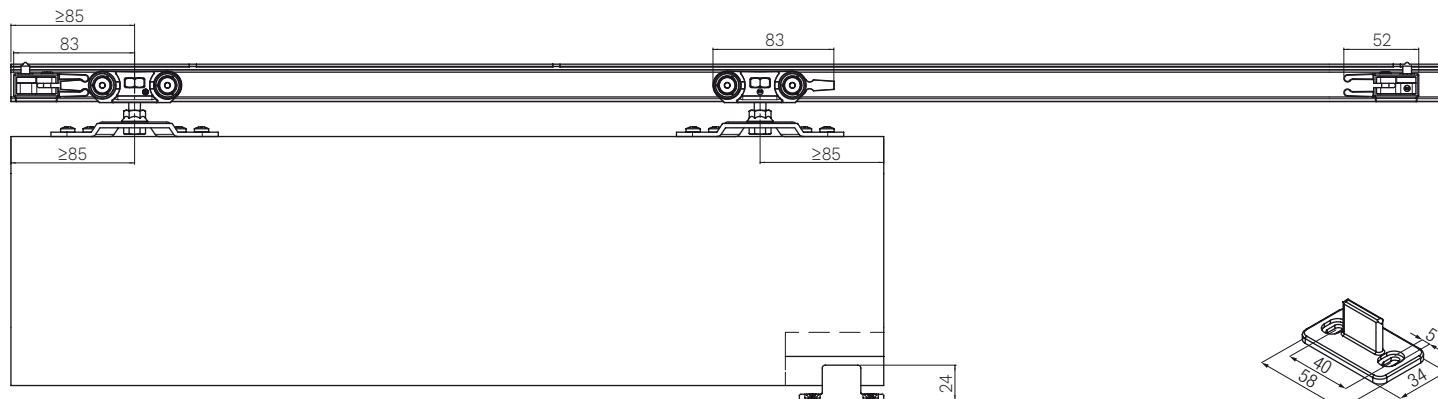

Technical drawings

Dimensions indicated in millimeters

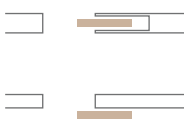
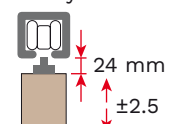
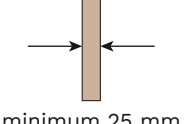
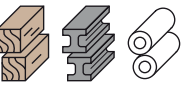

KIT 040040 230

Standard sliding door kit with a 2,3-meter track. POM roller, single-entry bracket, end stop. Load capacity 40 kg.

SLIDING Standard 	FIXING Standard single-entry bracket 	DOOR THICKNESS 	DOOR MATERIAL Wood, Metal and PVC 	SYSTEM LOAD CAPACITY Up to 40 kg 	ROLLERS Body: POM Wheels: 4 	INCLUDED IN THE KIT Track  2300 mm
--	---	--	--	--	---	---

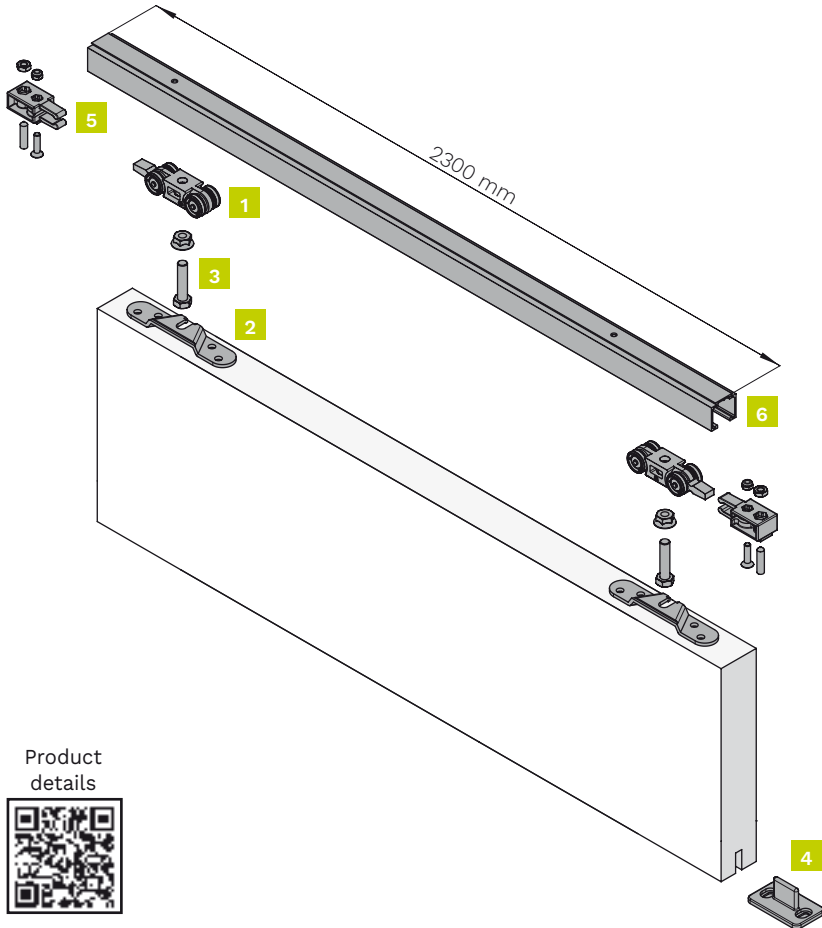

Kit components

1 door set

Item number: 040040 230

Figure	Component	Quantity
1	Upper roller - 40 kg	2 pieces
2	Single-entry bracket	2 pieces
3	Support screw for roller (hanger)	2 pieces
4	Adjustable lower guide	1 piece
5	End-stop	2 pieces
6	Track 2,3 meters	1 piece

Complete the set in the section "Tracks, Accessories and Spare parts".

Product details





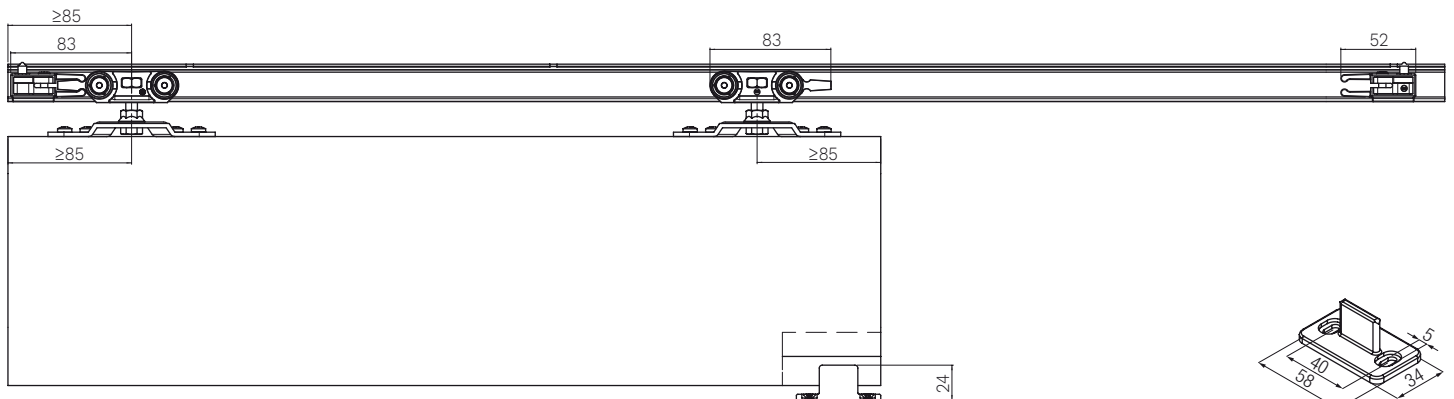

Technical drawings

Dimensions indicated in millimeters

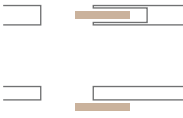
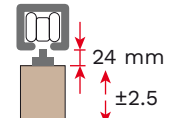
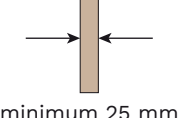
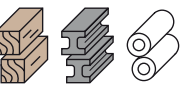

KIT 040040 300

Standard sliding door kit with a 3-meter track. POM roller, single-entry bracket, end stop. Load capacity 40 kg.

<p>SLIDING Standard</p> 	<p>FIXING Standard single-entry bracket</p> 	<p>DOOR THICKNESS</p> 	<p>DOOR MATERIAL Wood, Metal and PVC</p> 	<p>SYSTEM LOAD CAPACITY Up to 40 kg</p> 	<p>ROLLERS Body: POM Wheels: 4</p> 	<p>INCLUDED IN THE KIT Track 3000 mm</p> 
---	--	--	---	---	---	---

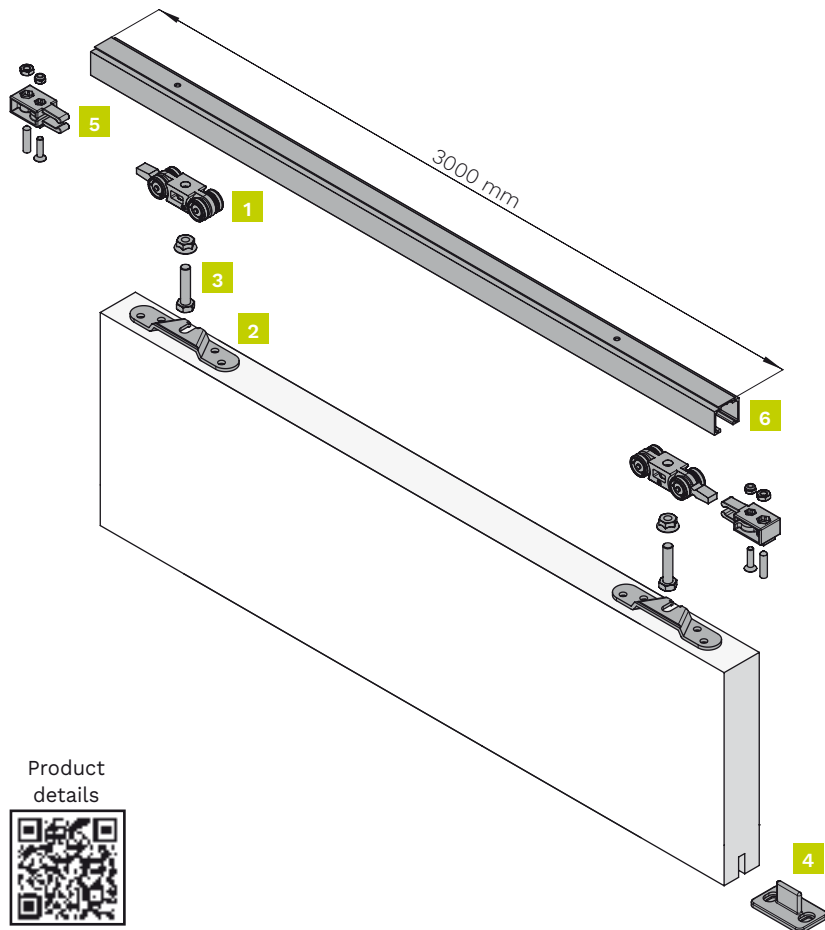

Kit components

1 door set
Item number: 040040 300

Figure	Component	Quantity
1	Upper roller - 40 kg	2 pieces
2	Single-entry bracket	2 pieces
3	Support screw for roller (hanger)	2 pieces
4	Adjustable lower guide	1 piece
5	End-stop	2 pieces
6	Track 3 meters	1 piece

Complete the set in the section "Tracks, Accessories and Spare parts".

Product details



Technical drawings

Dimensions indicated in millimeters

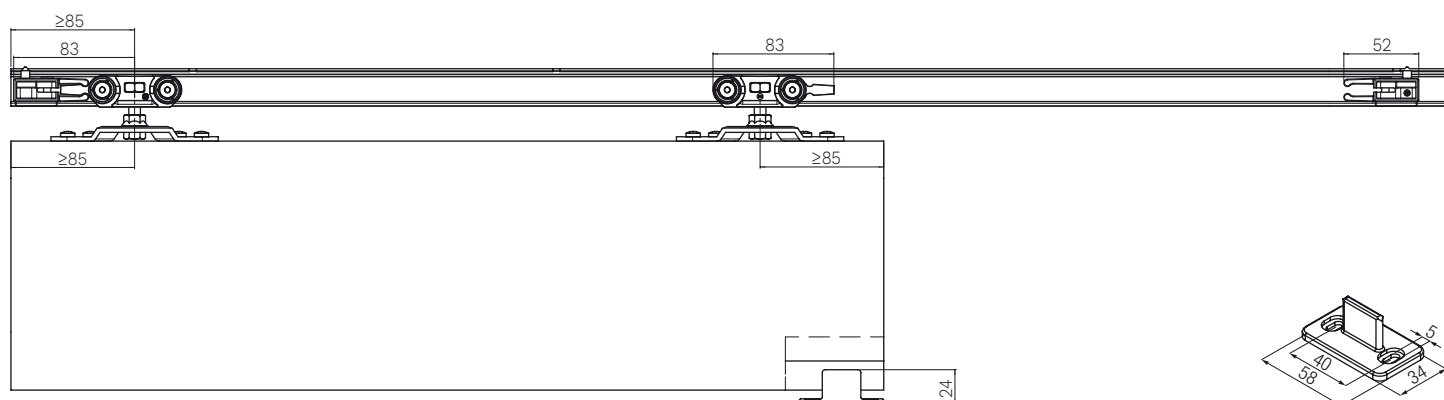

Tracks, Accessories and Spare parts 040040 160 / 040040 200 / 040040 230 / 040040 300

Complete the kit with track and accessory according to application.

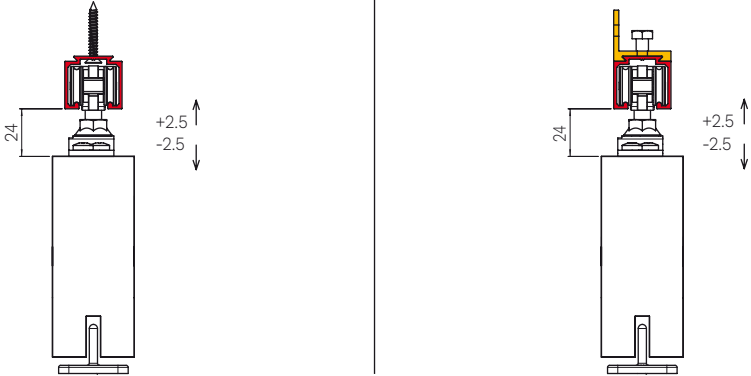
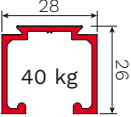
Installation examples	Dimensions tracks and accessories
<p>Dimensions indicated in millimeters</p> 	





Accessories	
Component	Item number.
L shape wall fixing - 40 kg	0400 5

Spare parts			
Component	*Quantity	Item number.	Which set is it for?
Upper roller - 40 kg	2 pieces	0400 54	040040 160 / 040040 200 / 040040 230 / 040040 300
Single-entry bracket	2 pieces	0400 53	040040 160 / 040040 200 / 040040 230 / 040040 300
Support screw for roller (hanger)	2 pieces	0400 51	040040 160 / 040040 200 / 040040 230 / 040040 300
Adjustable lower guide	20 pieces	0810 80x800	040040 160 / 040040 200 / 040040 230 / 040040 300
End-stop	2 pieces	0400 52	040040 160 / 040040 200 / 040040 230 / 040040 300
Drilled and anodised aluminium track - 40 kg - 2 meters	1 piece	0400 1 200	040040 160 / 040040 200 / 040040 230 / 040040 300
Drilled and anodised aluminium track - 40 kg - 3 meters	1 piece	0400 6	040040 160 / 040040 200 / 040040 230 / 040040 300
Drilled and anodised aluminium track - 40 kg - 4 meters	1 piece	0400 1 400	040040 160 / 040040 200 / 040040 230 / 040040 300
Drilled and anodised aluminium track - 40 kg - 6 meters	1 piece	0400 1	040040 160 / 040040 200 / 040040 230 / 040040 300
Raw aluminum track drilled - 40 kg - 3 meters	1 piece	0400 6G	040040 160 / 040040 200 / 040040 230 / 040040 300
Raw aluminum track drilled - 40 kg - 6 meters	1 piece	0400 1G	040040 160 / 040040 200 / 040040 230 / 040040 300

*The minimum order quantity is indicated.

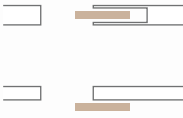
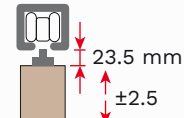
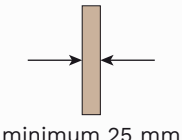
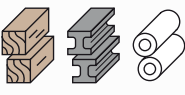
KIT 040080 150

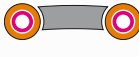
Standard sliding door kit with a 1,5-meter track. POM roller, single-entry bracket, end stop. Load capacity 80 kg.

<p>SLIDING Standard</p> 	<p>FIXING Standard single-entry bracket</p> 	<p>DOOR THICKNESS</p> 	<p>DOOR MATERIAL Wood, Metal and PVC</p> 	<p>SYSTEM LOAD CAPACITY Up to 80 kg</p> 	<p>ROLLERS Body: POM Wheels: 4 Ball bearings: 2</p> 	<p>INCLUDED IN THE KIT Track 1500 mm</p> 
---	--	--	---	---	--	---

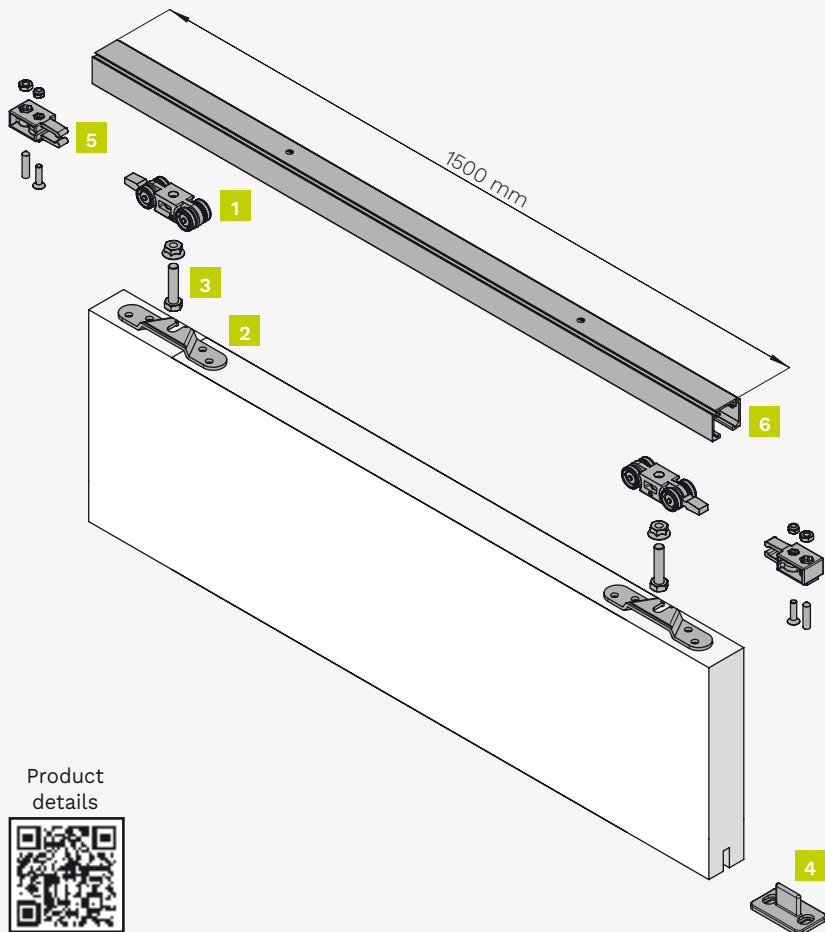

Kit components

1 door set

Item number: 040080 150

Figure	Component	Quantity
1	Upper roller - 80 kg	2 pieces
2	Single-entry bracket	2 pieces
3	Support screw for roller (hanger)	2 pieces
4	Adjustable lower guide	1 piece
5	End-stop	2 pieces
6	Track 1,5 meters	1 piece

Complete the set in the section "Tracks, Accessories and Spare parts".

Product details





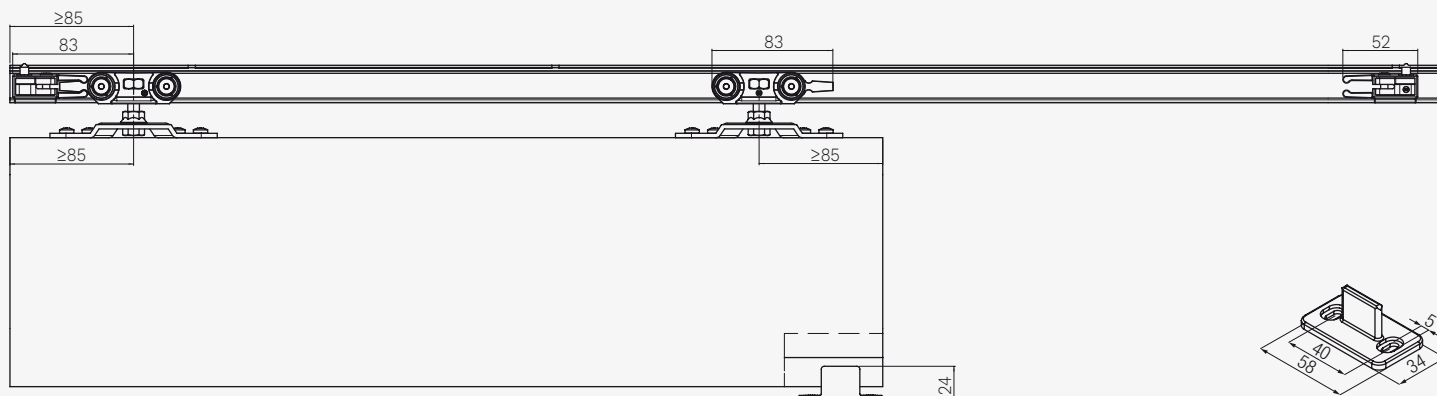

Technical drawings

Dimensions indicated in millimeters

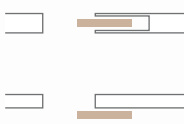
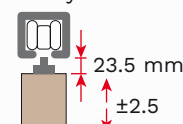
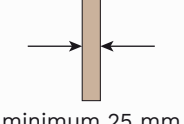
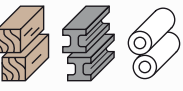

KIT 040080 200

Standard sliding door kit with a 2-meter track. POM roller, single-entry bracket, end stop. Load capacity 80 kg.

SLIDING Standard 	FIXING Standard single-entry bracket  23.5 mm ± 2.5	DOOR THICKNESS  minimum 25 mm	DOOR MATERIAL Wood, Metal and PVC 	SYSTEM LOAD CAPACITY Up to 80 kg 	ROLLERS Body: POM Wheels: 4 Ball bearings: 2 	INCLUDED IN THE KIT Track  2000 mm
--	---	---	--	--	---	---

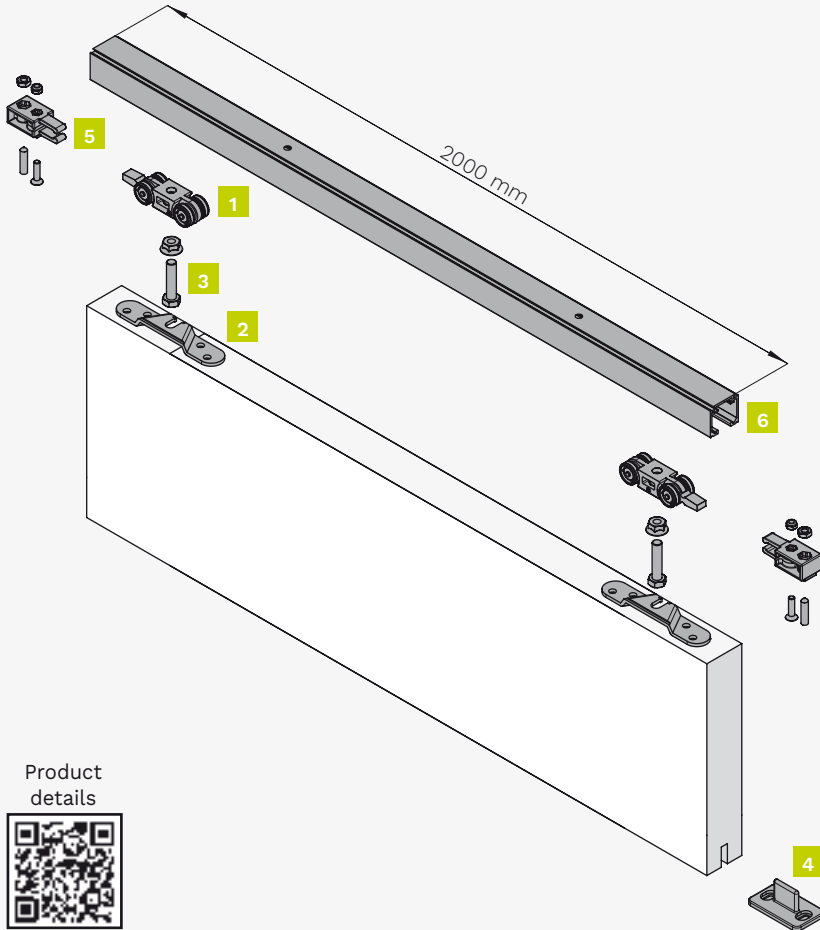

Kit components

1 door set

Item number: 040080 200

Figure	Component	Quantity
1	Upper roller - 80 kg	2 pieces
2	Single-entry bracket	2 pieces
3	Support screw for roller (hanger)	2 pieces
4	Adjustable lower guide	1 piece
5	End-stop	2 pieces
6	Track 2 meters	1 piece

Complete the set in the section "Tracks, Accessories and Spare parts".

Product details





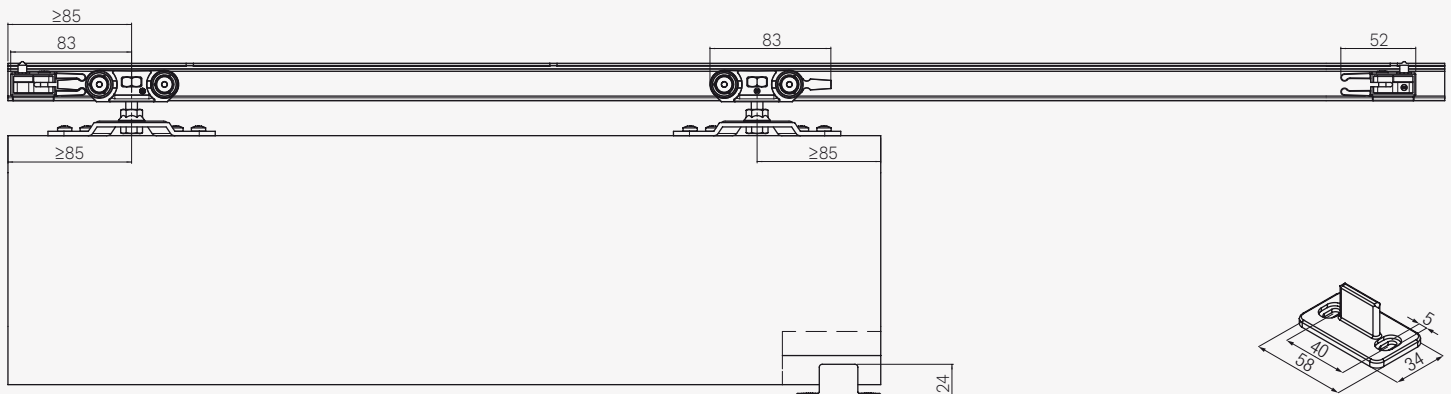

Technical drawings

Dimensions indicated in millimeters

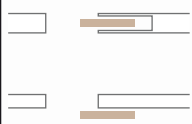
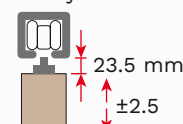
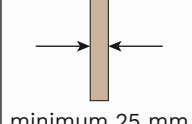
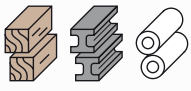

KIT 040080 230

Standard sliding door kit with a 2,3-meter track. POM roller, single-entry bracket, end stop. Load capacity 80 kg.

SLIDING Standard 	FIXING Standard single-entry bracket 	DOOR THICKNESS 	DOOR MATERIAL Wood, Metal and PVC 	SYSTEM LOAD CAPACITY Up to 80 kg 	ROLLERS Body: POM Wheels: 4 Ball bearings: 2 	INCLUDED IN THE KIT Track  2300 mm
--	---	--	--	--	---	---

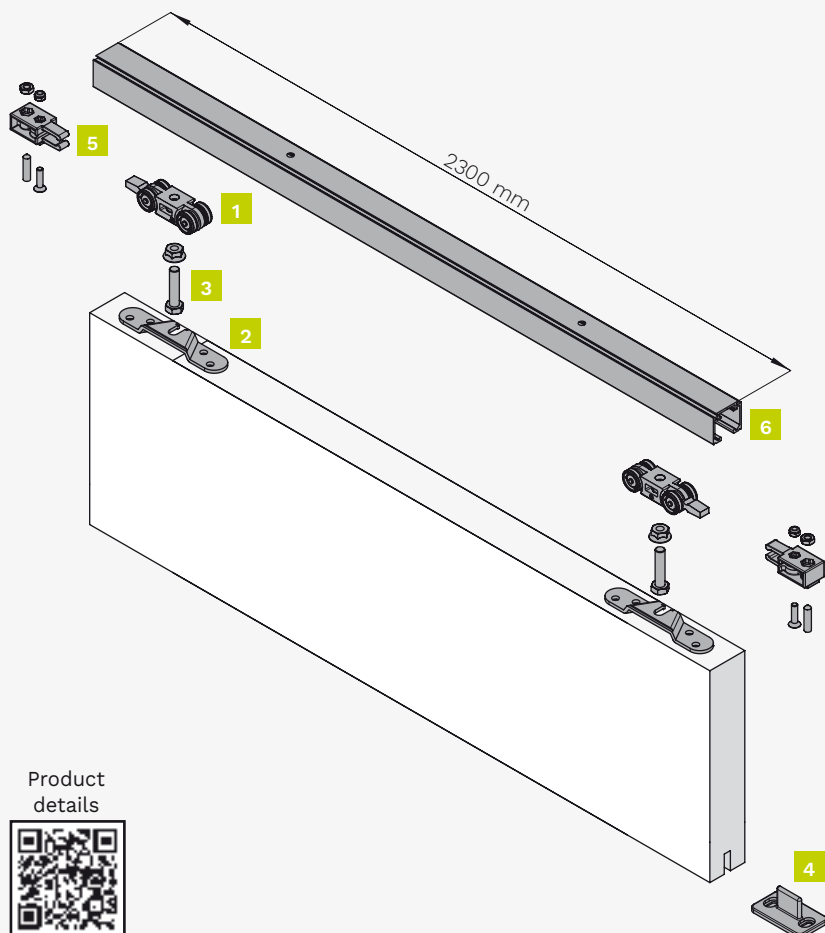

Kit components

1 door set

Item number: 040080 230

Figure	Component	Quantity
1	Upper roller - 80 kg	2 pieces
2	Single-entry bracket	2 pieces
3	Support screw for roller (hanger)	2 pieces
4	Adjustable lower guide	1 piece
5	End-stop	2 pieces
6	Track 2,3 meters	1 piece

Complete the set in the section "Tracks, Accessories and Spare parts".

Product details





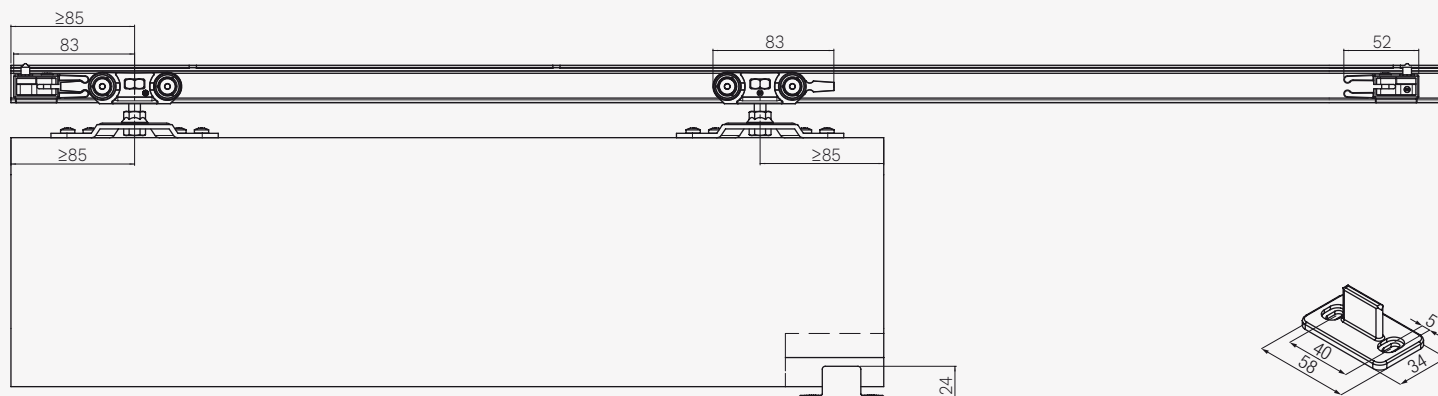

Technical drawings

Dimensions indicated in millimeters

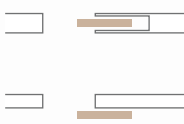
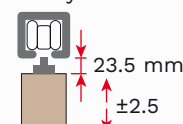
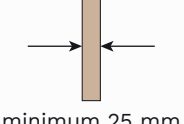
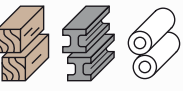

KIT 040080 300

Standard sliding door kit with a 3-meter track. POM roller, single-entry bracket, end stop. Load capacity 80 kg.

SLIDING Standard 	FIXING Standard single-entry bracket 	DOOR THICKNESS 	DOOR MATERIAL Wood, Metal and PVC 	SYSTEM LOAD CAPACITY Up to 80 kg 	ROLLERS Body: POM Wheels: POM Ball bearings: 2 	INCLUDED IN THE KIT Track  3000 mm
--	---	--	--	--	---	---

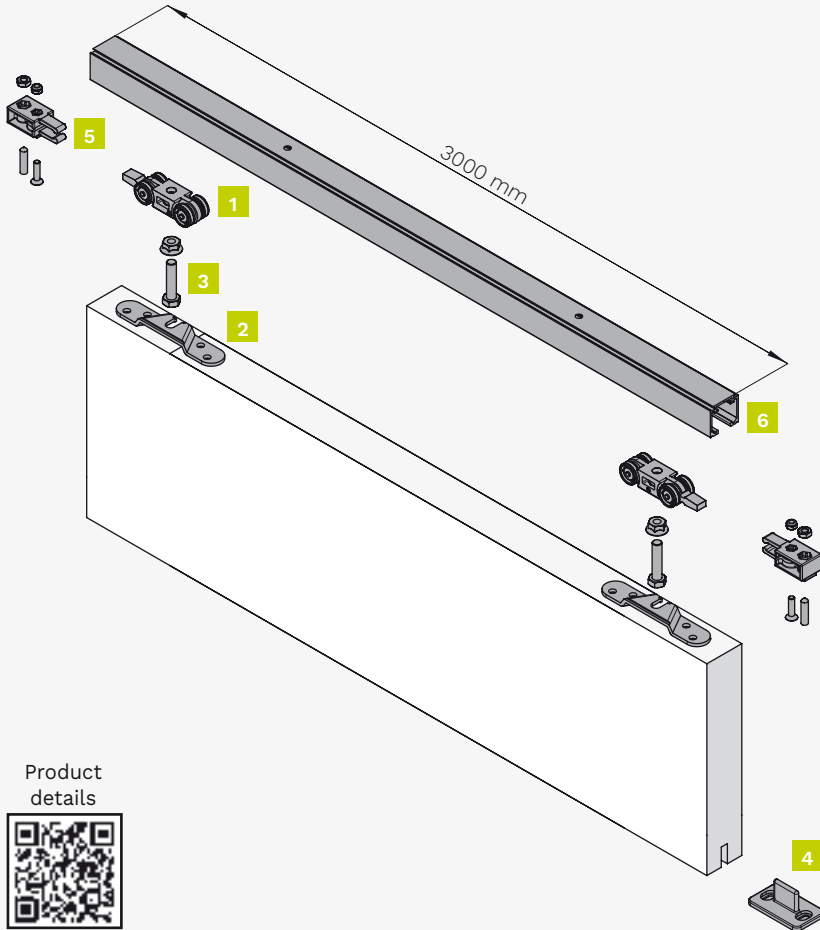

Kit components

1 door set

Item number: 040080 300

Figure	Component	Quantity
1	Upper roller - 80 kg	2 pieces
2	Single-entry bracket	2 pieces
3	Support screw for roller (hanger)	2 pieces
4	Adjustable lower guide	1 piece
5	End-stop	2 pieces
6	Track 3 meters	1 piece

Complete the set in the section "Tracks, Accessories and Spare parts".

Product details



Technical drawings

Dimensions indicated in millimeters

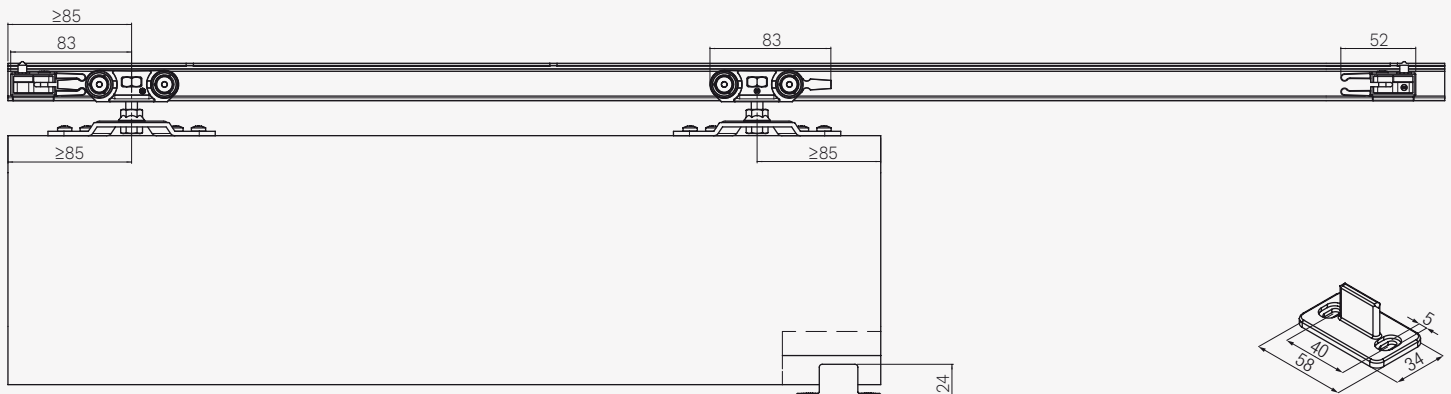

Tracks, Accessories and Spare parts 040080 150 / 040080 200 / 040080 230 / 040080 300

Complete the kit with track and accessory according to application.

Installation examples			Dimensions tracks and accessories	
Dimensions indicated in millimeters				

Accessories



Component	Item number.
Pelmet medium cover - 2 meters	0500 M 200
Pelmet medium cover - 3 meters	0500 M 300
Pelmet medium cover - 4 meters	0500 M 400
Pelmet high cover - 2 meters	0500 A 200
Pelmet high cover - 3 meters	0500 A 300
Pelmet high cover - 4 meters	0500 A 400
Wall fixing - 80 Kg - 2 meters	0500 F 200
Wall fixing - 80 Kg - 3 meters	0500 F 300
Wall fixing - 80 Kg - 4 meters	0500 F 400
L shape wall fixing - 80 kg	0500 4
Track end cap	0500 61
Pelmet medium end cap	0500 63
Pelmet high end cap	0500 64
ABS 60 kg opening and closing kit	0400 ABS BK

Spare parts

Component	*Quantity	Item number.	Which set is it for?
Upper roller - 80 kg	2 pieces	0400 55	040080 150 / 040080 200 / 040080 230 / 040080 300
Single-entry bracket	2 pieces	0400 53	040080 150 / 040080 200 / 040080 230 / 040080 300
Support screw for roller (hanger)	2 pieces	0400 51	040080 150 / 040080 200 / 040080 230 / 040080 300
Adjustable lower guide	20 pieces	0810 80x800	040080 150 / 040080 200 / 040080 230 / 040080 300
End-stop	2 pieces	0400 52	040080 150 / 040080 200 / 040080 230 / 040080 300
Drilled and anodised aluminium track - 80 kg - 2 meters	1 piece	0400 2 200	040080 150 / 040080 200 / 040080 230 / 040080 300
Drilled and anodised aluminium track - 80 kg - 3 meters	1 piece	0400 7	040080 150 / 040080 200 / 040080 230 / 040080 300
Drilled and anodised aluminium track - 80 kg - 4 meters	1 piece	0400 2 400	040080 150 / 040080 200 / 040080 230 / 040080 300
Drilled and anodised aluminium track - 80 kg - 6 meters	1 piece	0400 2	040080 150 / 040080 200 / 040080 230 / 040080 300

*The minimum order quantity is indicated.

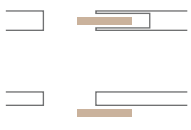
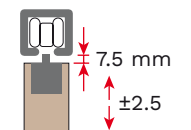
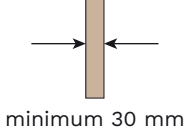
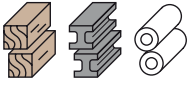
SYSTEM BASIC 0450

<p>SLIDING Standard</p> 	<p>FIXING Bracket embedded in the door</p> 	<p>DOOR THICKNESS</p>  <p>minimum 30 mm</p>	<p>DOOR MATERIAL Wood, Metal and PVC</p> 	<p>SYSTEM LOAD CAPACITY Up to 80 kg</p> 	<p>ROLLERS Body: POM Wheels: 4 Ball bearings: 2</p> 
<p>SOFT-CLOSE</p> <p>ABS ●●●●●●</p> <p>SINGLE</p> <p>Type: Mechanic Covering: Plastic</p>					

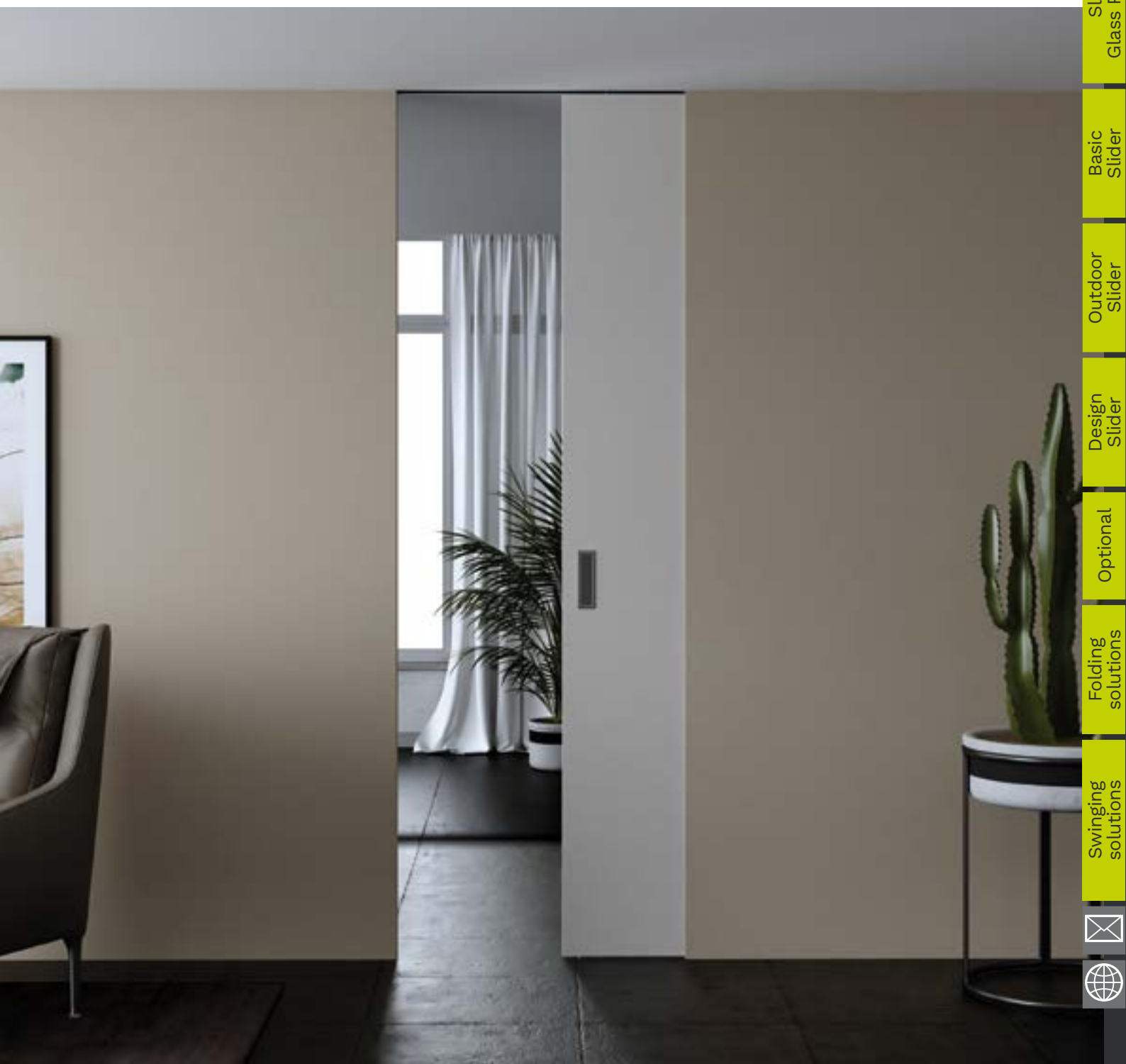

INDEX

A sliding set for Basic system 0450



Set	Load capacity	Door thickness	Sliding	Soft-close	Page
0450 3	40 kg	minimum 30 mm	Standard 	No	102
Tracks, Accessories and Spare parts 0450 3					103
0450 4	80 kg	minimum 30 mm	Standard 	No	104
0450 4 1ABS	60 kg	minimum 30 mm	Standard 	Yes (1 device)	105
0450 4 2ABS	60 kg	minimum 30 mm	Standard 	Yes (2 devices)	106
Tracks, Accessories and Spare parts 0450 4 / 0450 4 1ABS / 0450 4 2ABS					107

Optional

System	Description	Item number.	Page
New Kit Klose	Self closing - outside the wall	0880 1	149
	Self closing - inside the wall	0880 2	150
2000	Parallel door sliding gear	2000	152

KIT 0450 3

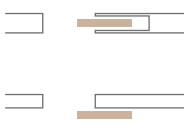
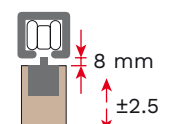
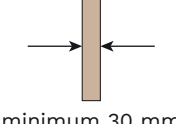
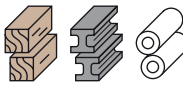
Standard sliding door kit. POM roller, single-entry bracket, end stop. Load capacity 40 kg.

<p>SLIDING Standard</p> 	<p>FIXING Bracket embedded in the door</p> 	<p>DOOR THICKNESS</p> 	<p>DOOR MATERIAL Wood, Metal and PVC</p> 	<p>SYSTEM LOAD CAPACITY Up to 40 kg</p> 	<p>ROLLERS Body: POM Wheels: 4</p> 
---	---	--	---	---	---

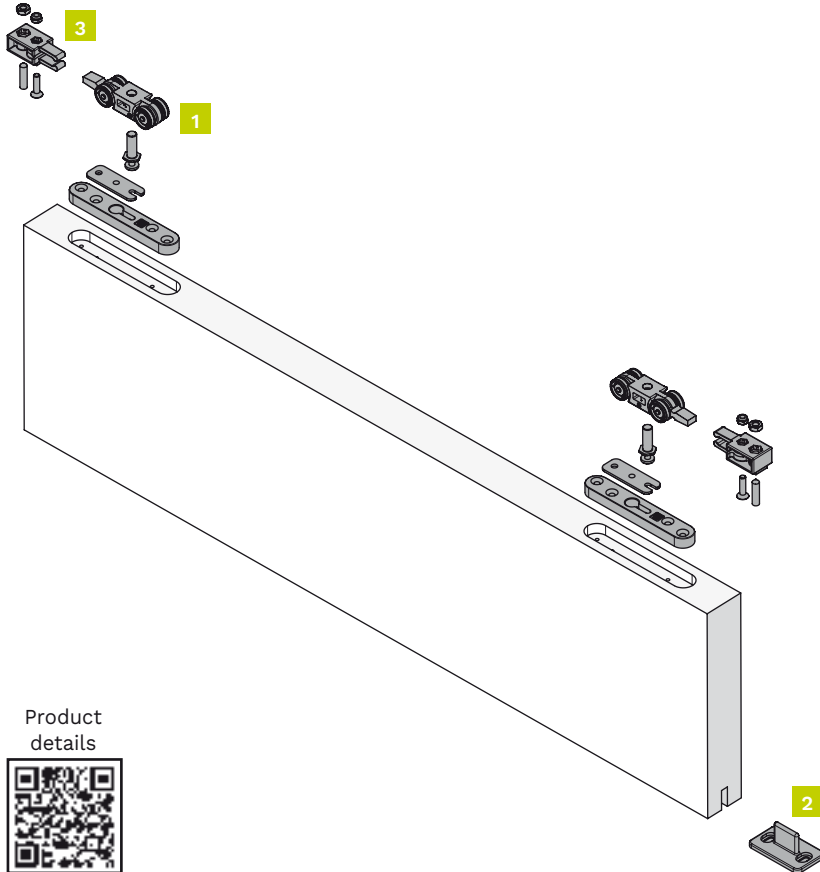

Kit components

1 door set

Item number: 0450 3

Figure	Component	Quantity
1	Roller with built-in bracket - 40 kg	2 pieces
2	Adjustable lower guide	1 piece
3	End-stop	2 pieces
-	Fork wrench	1 piece

Complete the set in the section "Tracks, Accessories and Spare parts".

Product details



Technical drawings

Dimensions indicated in millimeters

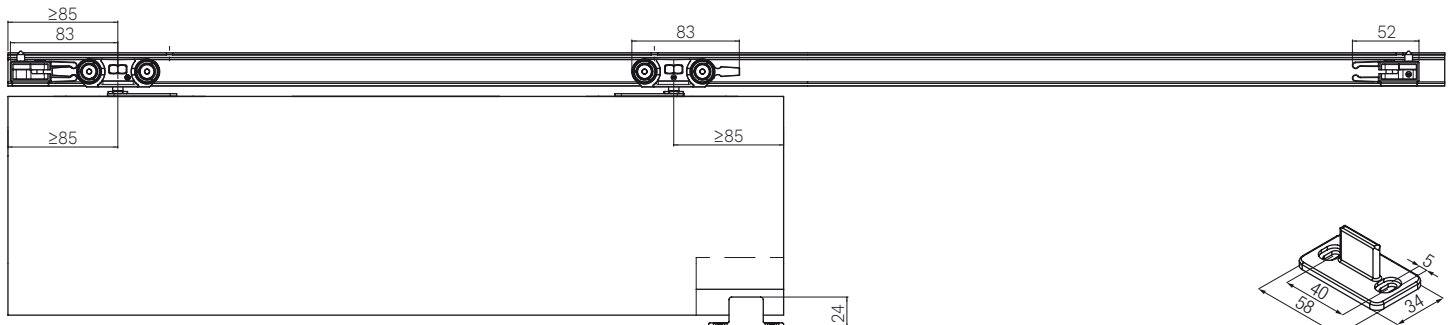

Tracks, Accessories and Spare parts 0450 3

Complete the kit with track and accessory according to application.

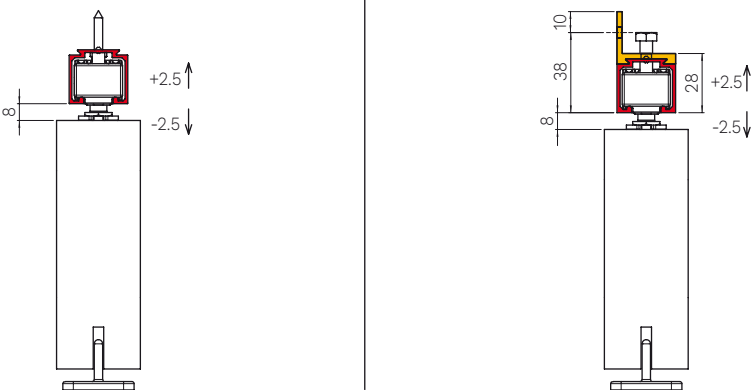
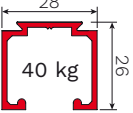
Installation examples	Dimensions tracks and accessories
<p>Dimensions indicated in millimeters</p> 	

Tracks	
Drilled and anodised aluminium track - 40 kg	Item number.
2 meters	0400 1 200
3 meters	0400 6
4 meters	0400 1 400
6 meters	0400 1
Raw aluminum track drilled - 40 kg	Item number.
3 meters	0400 6G
6 meters	0400 1G



Accessories	
Component	Item number.
L shape wall fixing - 40 kg	0400 5

Spare parts			
Component	*Quantity	Item number.	Which set is it for?
Roller with built-in bracket - 40 kg	2 pieces	0450 51	0450 3
Adjustable lower guide	20 pieces	0810 80x800	0450 3
End-stop	2 pieces	0400 52	0450 3

*The minimum order quantity is indicated.

KIT 0450 4

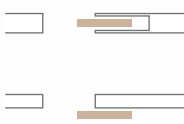
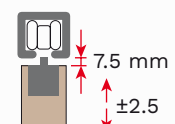
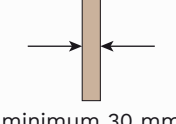
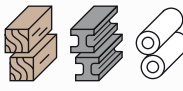
Standard sliding door kit. POM roller, single-entry bracket, end stop. Load capacity 80 kg.

<p>SLIDING Standard</p> 	<p>FIXING Bracket embedded in the door</p> 	<p>DOOR THICKNESS</p> 	<p>DOOR MATERIAL Wood, Metal and PVC</p> 	<p>SYSTEM LOAD CAPACITY Up to 80 kg</p> 	<p>ROLLERS Body: POM Wheels: 4 Ball bearings: 2</p> 
---	---	--	---	---	--

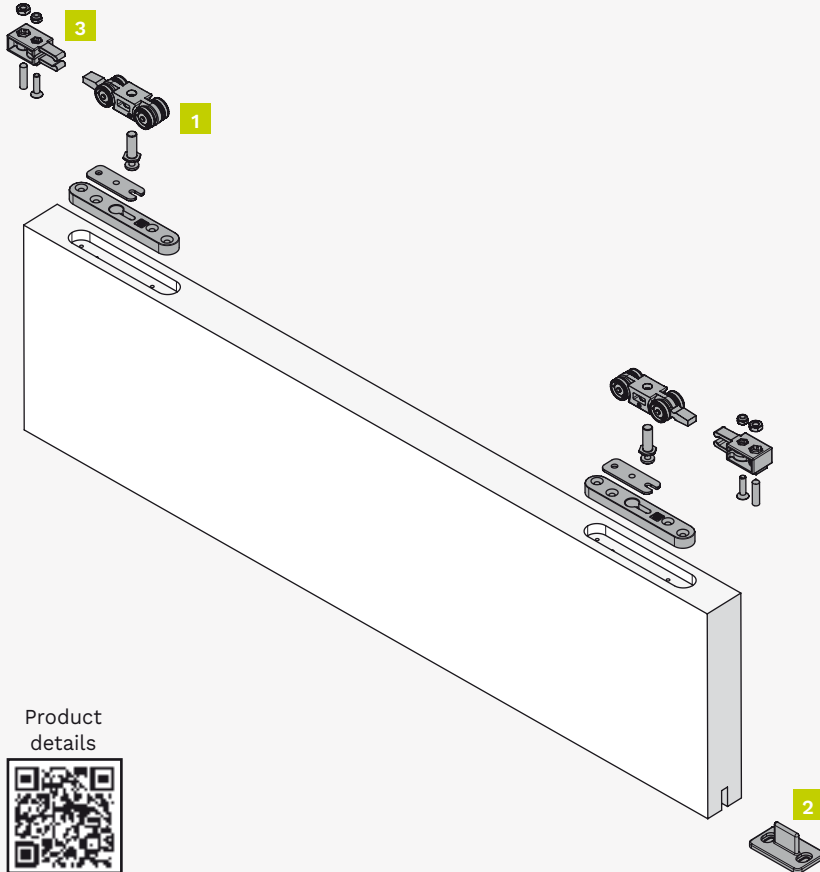

Kit components

1 door set

Item number: 0450 4

Figure	Component	Quantity
1	Roller with built-in bracket - 80 kg	2 pieces
2	Adjustable lower guide	1 piece
3	End-stop	2 pieces
-	Fork wrench	1 piece

Complete the set in the section "Tracks, Accessories and Spare parts".

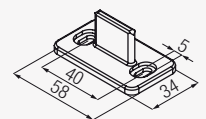
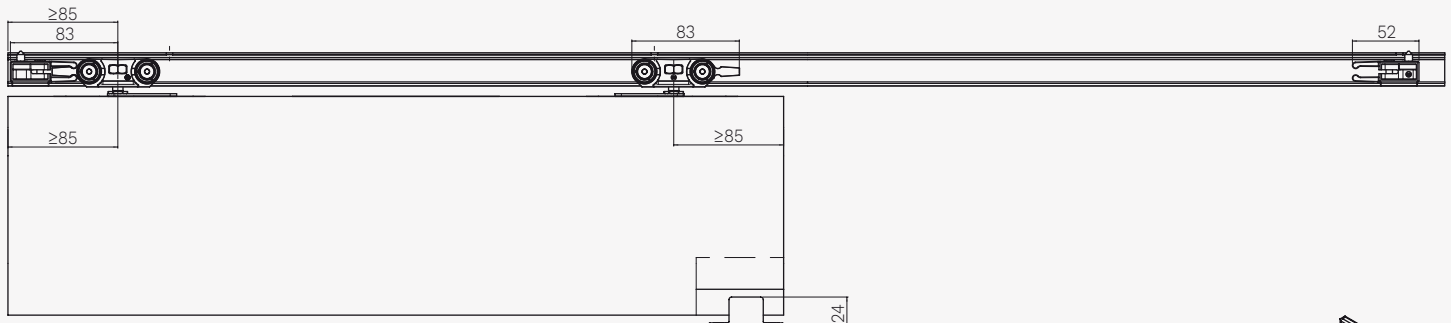

Technical drawings

Dimensions indicated in millimeters

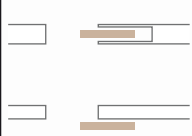
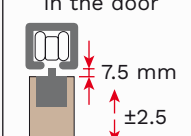
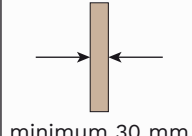
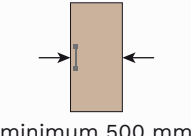
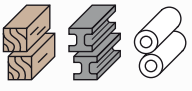

KIT 0450 4 1ABS

Standard sliding door kit. POM roller, single-entry bracket, end stop, single ABS soft closing. Load capacity 60 kg.

SLIDING Standard 	FIXING Bracket embedded in the door  7.5 mm ± 2.5	DOOR THICKNESS  minimum 30 mm	DOOR LEAF WIDTH  minimum 500 mm	DOOR MATERIAL Wood, Metal and PVC 	SYSTEM LOAD CAPACITY Up to 60 kg 	ROLLERS Body: POM Wheels: 4 Ball bearings: 2 
--	---	---	---	---	---	---

SOFT-CLOSE

ABS ●●●●●●●●

SINGLE

Type: Mechanic
Covering: Plastic

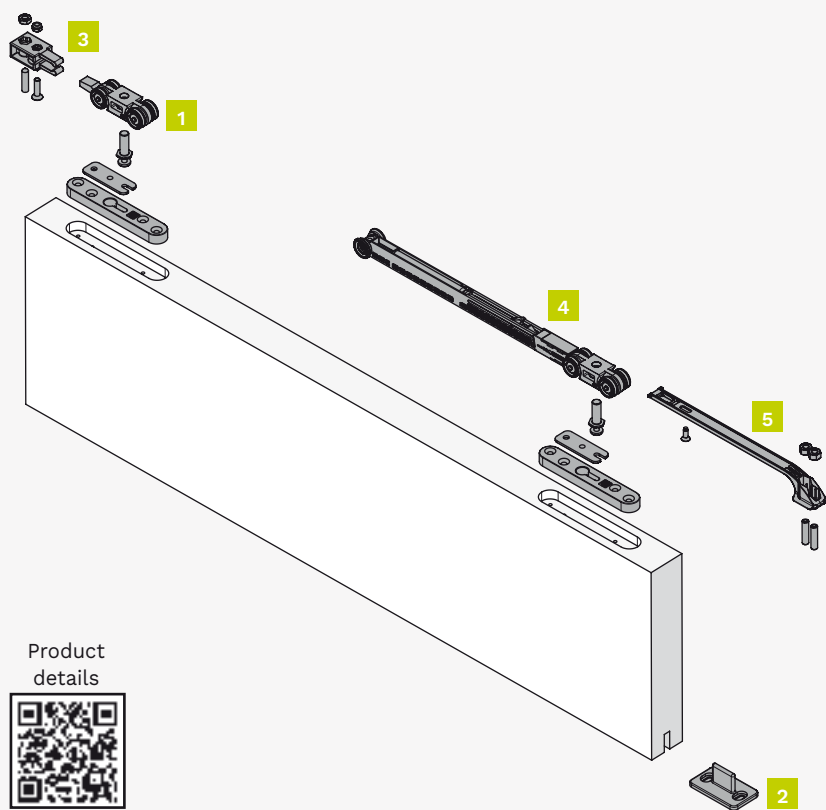

Kit components

1 door set
Item number: 0450 4 1ABS

Figure	Component	Quantity
1	Roller with built-in bracket - 80 kg	2 pieces
2	Adjustable lower guide	1 piece
3	End-stop	1 piece
4	Soft close device (single ABS) - 60 kg	1 piece
5	Single ABS activator	1 piece

Complete the set in the section "Tracks, Accessories and Spare parts".



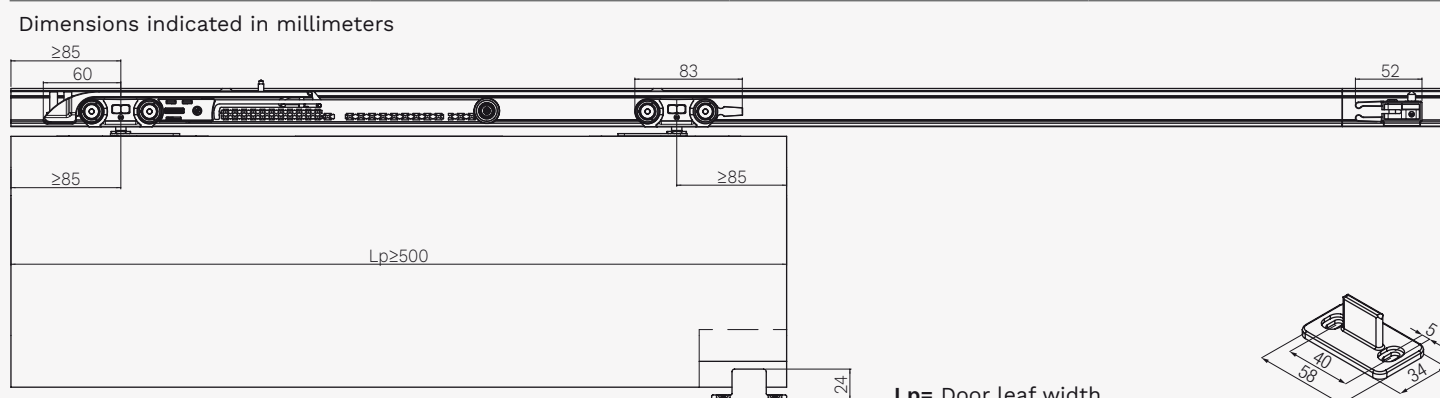

Technical drawings

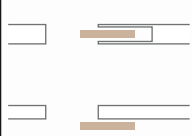
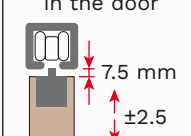
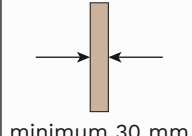
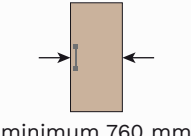
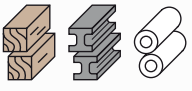

KIT 0450 4 2ABS

Standard sliding door kit. POM roller, single-entry bracket, two single ABS soft door closing. Load capacity 60 kg.

SLIDING Standard 	FIXING Bracket embedded in the door  7.5 mm ± 2.5	DOOR THICKNESS  minimum 30 mm	DOOR LEAF WIDTH  minimum 760 mm	DOOR MATERIAL Wood, Metal and PVC 	SYSTEM LOAD CAPACITY Up to 60 kg 	ROLLERS Body: POM Wheels: 4 Ball bearings: 2 
--	---	---	---	---	---	---

SOFT-CLOSE

ABS ●●●●●●●●

SINGLE

Type: Mechanic
Covering: Plastic

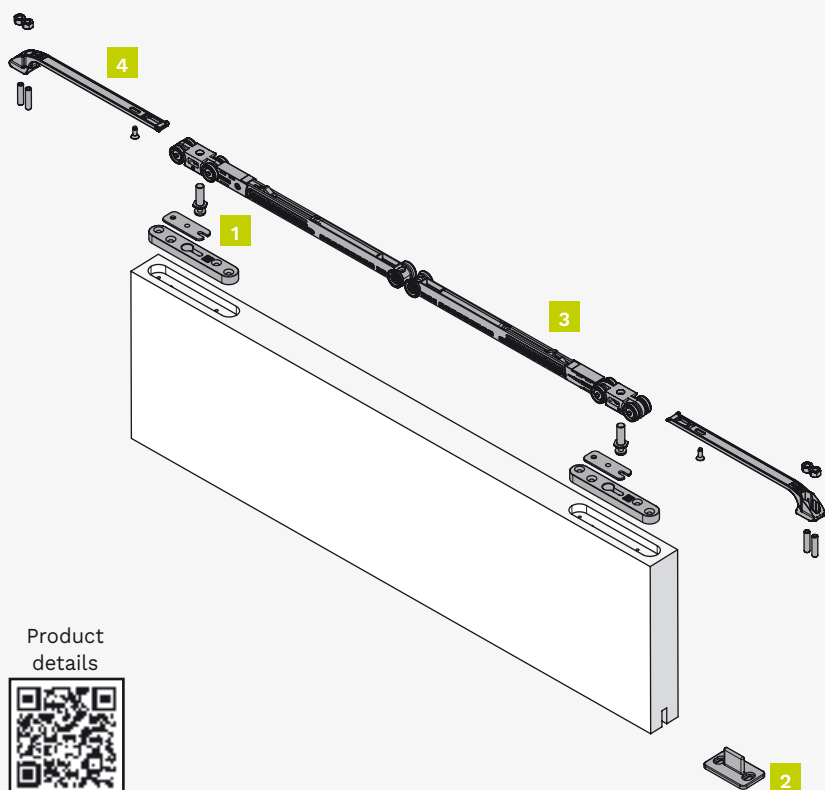

Kit components

1 door set
Item number: 0450 4 2ABS

Figure	Component	Quantity
1	Roller with built-in bracket - 80 kg	2 pieces
2	Adjustable lower guide	1 piece
3	Soft close device (single ABS) - 60 kg	2 pieces
4	Single ABS activator	2 pieces

Complete the set in the section "Tracks, Accessories and Spare parts".

Product details



Technical drawings

Dimensions indicated in millimeters

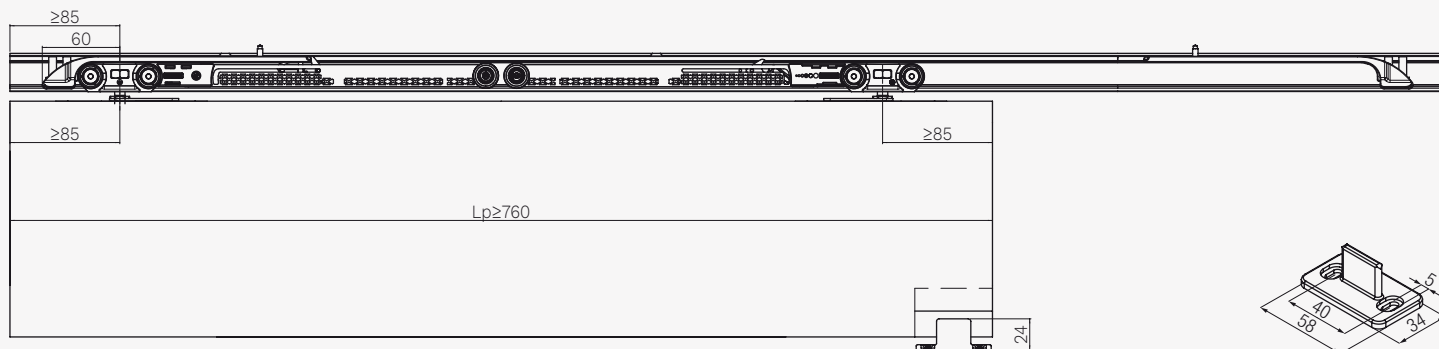

Lp= Door leaf width

Tracks, Accessories and Spare parts 0450 4 / 0450 4 1ABS / 0450 4 2ABS

Complete the kit with track and accessory according to application.

Installation examples				Dimensions tracks and accessories	
Dimensions indicated in millimeters					

Tracks

Drilled and anodised aluminium track - 80 kg	Item number.
2 meters	0400 2 200
3 meters	0400 7
4 meters	0400 2 400
6 meters	0400 2

Accessories

Component	Item number.
False ceiling profile - 2 meters	0500 C 200
False ceiling profile - 3 meters	0500 C 300
False ceiling profile - 4 meters	0500 C 400
Wall fixing - 80 Kg - 2 meters	0500 F 200
Wall fixing - 80 Kg - 3 meters	0500 F 300
Wall fixing - 80 Kg - 4 meters	0500 F 400
L shape wall fixing - 80 kg	0500 4
Track end cap	0500 61
Side closing wall fixing	0500 62
ABS 60 kg opening and closing kit	0400 ABS BK

Spare parts

Component	*Quantity	Item number.	Which set is it for?
Roller with built-in bracket - 80 kg	2 pieces	0450 52	0450 4 / 0450 4 1ABS / 0450 4 2ABS
Adjustable lower guide	20 pieces	0810 80x800	0450 4 / 0450 4 1ABS / 0450 4 2ABS
End-stop	2 pieces	0400 52	0450 4 / 0450 4 1ABS
Soft close device (single ABS) - 60 kg	1 piece	0400 ABS	0400 4 1ABS / 0400 4 2ABS
Single ABS activator	1 piece	0400 52 ABS	0400 4 1ABS / 0400 4 2ABS
Fixing plates + screws for hooking profile to a wall 0500 F	100 pieces	0500 58	0450 4 / 0450 4 1ABS / 0450 4 2ABS

*The minimum order quantity is indicated.

OUTDOOR SERIES



Sliding systems for wooden, metal and PVC doors







FEATURES:









1. **ROLLER** 4 different rollers according to the maximum load capacity.
 - **0800:** made of zamak body and POM (Polyoxymethylene) wheels connected by a stainless steel pin. Maximum load capacity 60 Kg.
 - **0810:** made of aluminum body and POM (Polyoxymethylene) wheels connected by a stainless steel pin. Maximum load capacity 100 Kg.
 - **0830:** made of zamak body and POM (Polyoxymethylene) wheels connected by a stainless steel pin. Maximum load capacity 175 Kg.
 - **0850:** made of aluminum body and POM (Polyoxymethylene) wheels connected by a stainless steel pin. Maximum load capacity 250 Kg.
2. **FIXING**
 - **DOUBLE-ENTRY BRACKET** for front and side door leaf hanging into the 0800 and 0810 systems.
 - **SINGLE-ENTRY BRACKET** for door leaf hanging into the 0830 and 0850 systems.
3. **END-STOP.**
4. **ADJUSTABLE FLOOR GUIDE**, the buttonholes allow to adjust the guide positioning. The selection - among different diameters - of the plastic wheel that best fits the door leaf bottom milling provide a fluid sliding.
5. **IDEAL FOR OUTDOOR USE.**
6. **LOAD CAPACITY UP TO 250 KG.**

ROLLER
<p>0800: 60 kg</p> 
<p>0810: 100 kg</p> 
<p>0830: 175 kg</p> 
<p>0850: 250 kg</p> 

FIXING
<p>DOUBLE-ENTRY BRACKET</p> <p>0800 - 0810</p> 
<p>SINGLE-ENTRY BRACKET</p> <p>0830</p>  <p>0850</p> 

FLOOR GUIDE

END-STOP			
0800:	0810:	0830:	0850:
			

System	Load capacity	Door material	Sliding	Fixing	Page
0800	60 kg		Outdoor 	Standard double-entry bracket	112
0810	100 kg		Outdoor 	Standard double-entry bracket	116
0830	175 kg		Outdoor 	Standard single-entry bracket	120
0850	250 kg		Outdoor 	Standard single-entry bracket	124

TERMS AND DEFINITIONS

• DOOR MATERIAL



Wood



Metal



PVC

• SLIDING



Outdoor

The solution that allows the creation of sliding doors suitable for outdoor conditions.

• WOOD FIXING

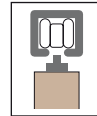

Standard double-entry bracket

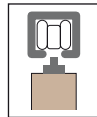

An anchor bracket fixed in the upper part of the door leaf. The two way use allows both its front and lateral mounting.



Standard single-entry bracket

An anchor bracket fixed in the upper part of the door leaf.

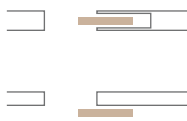
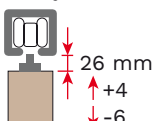
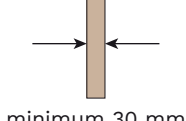
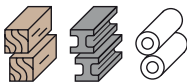
SYSTEM OUTDOOR 0800

<p>SLIDING Outdoor</p> 	<p>FIXING Standard double-entry bracket</p> 	<p>DOOR THICKNESS</p>  <p>minimum 30 mm</p>	<p>DOOR MATERIAL Wood, Metal and PVC</p> 	<p>SYSTEM LOAD CAPACITY Up to 60 kg</p> 	<p>ROLLERS Body: Zamak Wheels: 2 Pin: stainless steel</p> 
---	--	---	---	--	--



INDEX

A sliding set for Outdoor system 0800

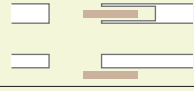
Set	Load capacity	Door thickness	Sliding	Page
0800 3	60 kg	minimum 30 mm	Outdoor 	114
Tracks, Accessories and Spare parts 0800 3				115

Optional

System	Description	Item number.	Page
New Kit Klose	Self closing - outside the wall	0880 1	149
	Self closing - inside the wall	0880 2	150
2000	Parallel door sliding gear	2000	152

KIT 0800 3

Sliding door kit for outdoor and humid environment. Zamak roller, stainless steel pin, single-entry bracket, end stop. Load capacity 60 kg.

<p>SLIDING Outdoor</p>	<p>FIXING Standard double-entry bracket</p>	<p>DOOR THICKNESS</p> <p>minimum 30 mm</p>	<p>DOOR MATERIAL Wood, Metal and PVC</p>	<p>SYSTEM LOAD CAPACITY Up to 60 kg</p>	<p>ROLLERS Body: Zamak Wheels: 2 Pin: stainless steel</p>
-----------------------------------	--	---	---	--	--

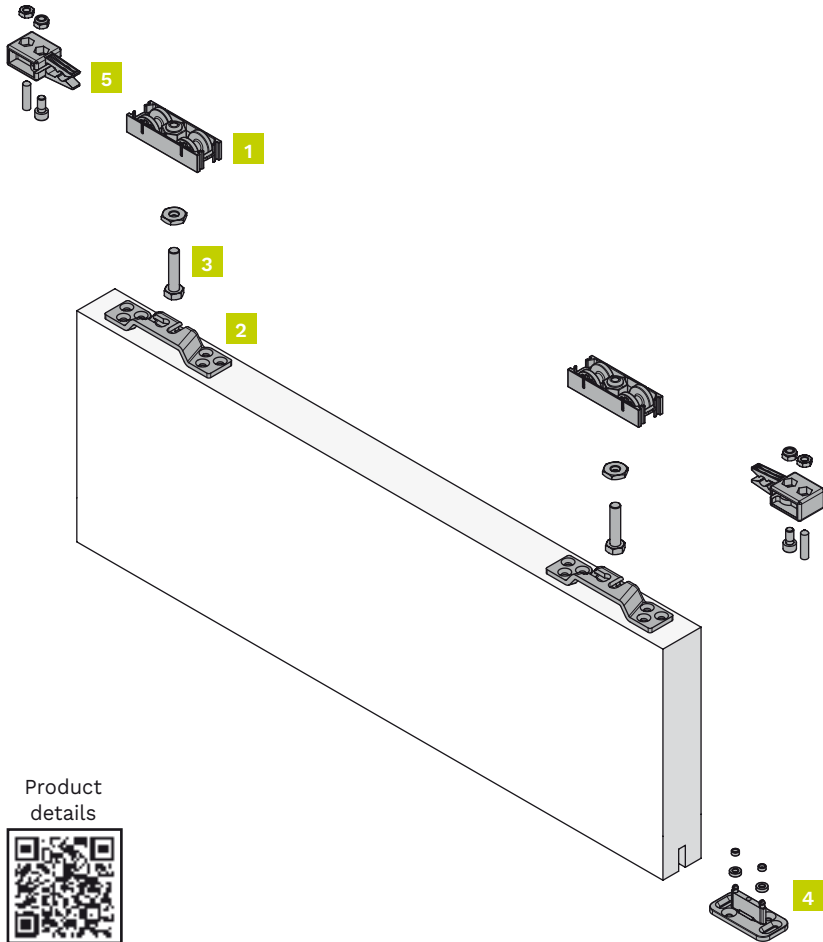

Kit components

1 door set
Item number: 0800 3

Figure	Component	Quantity
1	Upper roller - 60 kg	2 pieces
2	Double hooking door bracket	2 pieces
3	Support screw for roller (hanger)	2 pieces
4	Adjustable lower guide	1 piece
5	End-stop	2 pieces
-	Valve seat wrench	1 piece
-	Fork wrench	1 piece

Complete the set in the section "Tracks, Accessories and Spare parts".

Technical drawings

Dimensions indicated in millimeters

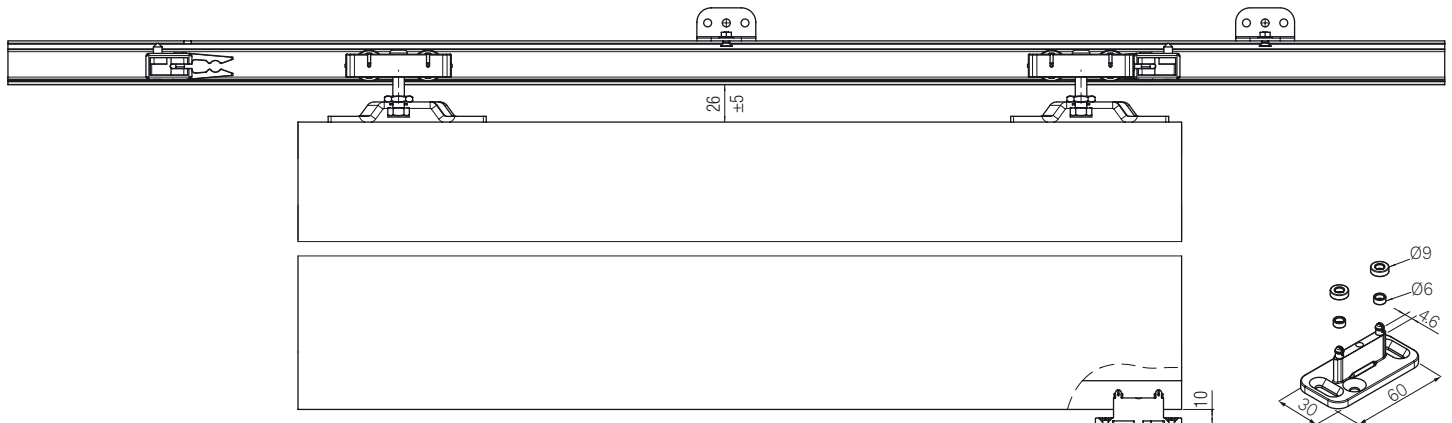

Tracks, Accessories and Spare parts 0800 3

Complete the kit with track and accessory according to application.

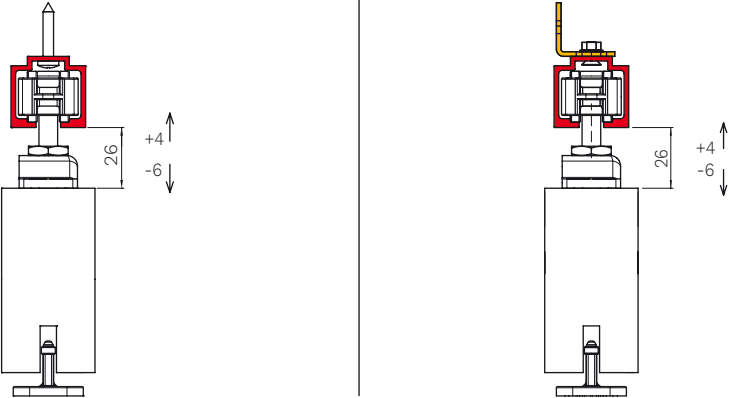
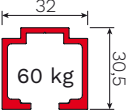
Installation examples	Dimensions tracks and accessories
<p>Dimensions indicated in millimeters</p> 	

Tracks

Drilled and anodised aluminium track - 60 kg	Item number.
3 meters	0800 2
6 meters	0800 1

Accessories



Component	Item number.
L shape wall fixing - 60 kg	0800 5

Spare parts

Component	*Quantity	Item number.	Which set is it for?
Upper roller - 60 kg	2 pieces	0800 51	0800 3
Double hooking door bracket	2 pieces	0500 55	0800 3
Support screw for roller (hanger)	2 pieces	0500 54	0800 3
Adjustable lower guide	20 pieces	0500 13	0800 3
End-stop	2 pieces	0800 4	0800 3

*The minimum order quantity is indicated.

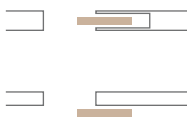
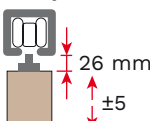
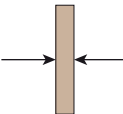
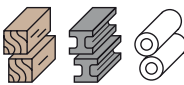
SYSTEM OUTDOOR 0810

<p>SLIDING Outdoor</p> 	<p>FIXING Standard double-entry bracket</p> 	<p>DOOR THICKNESS</p>  <p>minimum 30 mm</p>	<p>DOOR MATERIAL Wood, Metal and PVC</p> 	<p>SYSTEM LOAD CAPACITY Up to 100 kg</p> 	<p>ROLLERS Body: Aluminum Wheels: 2 Pin: stainless steel</p> 
---	--	---	---	---	---



INDEX

A sliding set for Outdoor system 0810

Set	Load capacity	Door thickness	Sliding	Page
0810 80x300	100 kg	minimum 30 mm	Outdoor 	118
Tracks, Accessories and Spare parts 0810 80x300				119

Optional

System	Description	Item number.	Page
New Kit Klose	Self closing - outside the wall	0880 1	149
	Self closing - inside the wall	0880 2	150
2000	Parallel door sliding gear	2000	152

KIT 0810 80X300

Sliding door kit for outdoor and humid environment. Aluminum roller, stainless steel pin, double-entry bracket, end stop. Load capacity 100 kg.

<p>SLIDING Outdoor</p>	<p>FIXING Standard double-entry bracket</p>	<p>DOOR THICKNESS</p> <p>minimum 30 mm</p>	<p>DOOR MATERIAL Wood, Metal and PVC</p>	<p>SYSTEM LOAD CAPACITY Up to 100 kg</p>	<p>ROLLERS Body: Aluminum Wheels: 2 Pin: stainless steel</p>
-----------------------------------	--	---	---	---	---

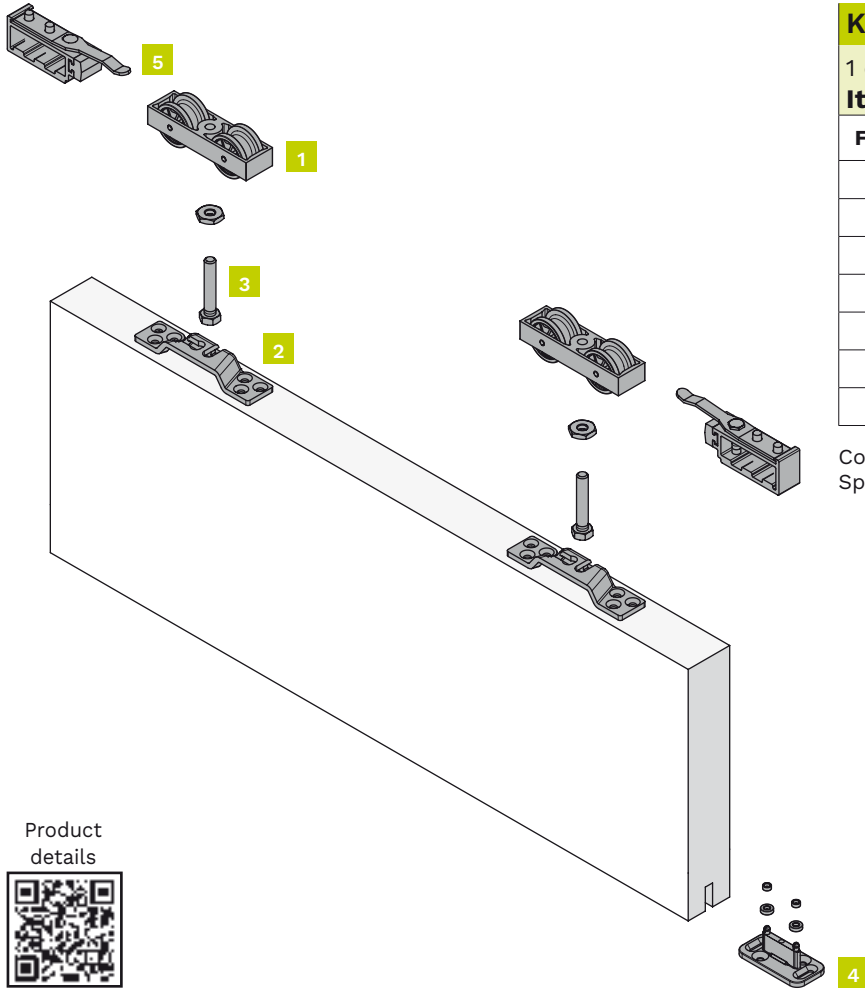

Kit components

1 door set
Item number: 0810 80x300

Figure	Component	Quantity
1	Upper roller - 100 kg	2 pieces
2	Double hooking door bracket	2 pieces
3	Support screw for roller (hanger)	2 pieces
4	Adjustable lower guide	1 piece
5	End-stop	2 pieces
-	Valve seat wrench	1 piece
-	Fork wrench	1 piece

Complete the set in the section "Tracks, Accessories and Spare parts".

Technical drawings

Dimensions indicated in millimeters

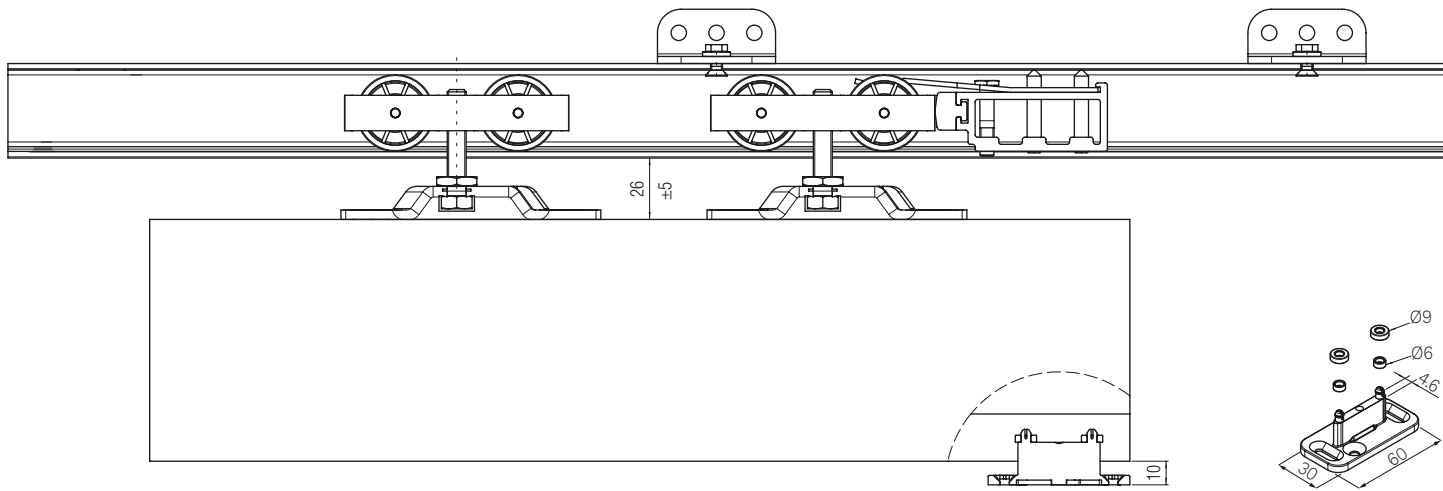

Tracks, Accessories and Spare parts 0810 80x300

Complete the kit with track and accessory according to application.

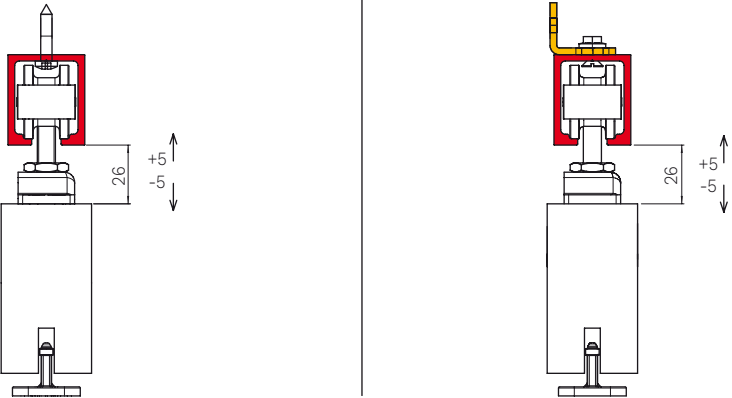
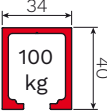
Installation examples	Dimensions tracks and accessories
<p>Dimensions indicated in millimeters</p> 	

Tracks

Drilled and anodised aluminium track - 100 kg	Item number.
2 meters	0810 80x200
3 meters	0810 80x900
6 meters	0810 80x400

Accessories



Component	Item number.
L shape wall fixing - 100 kg	0810 80x700

Spare parts

Component	*Quantity	Item number.	Which set is it for?
Upper roller - 100 kg	2 pieces	0810 53	0810 80x300
Double hooking door bracket	2 pieces	0500 55	0810 80x300
Support screw for roller (hanger)	2 pieces	0810 51	0810 80x300
Adjustable lower guide	20 pieces	0500 13	0810 80x300
End-stop	1 piece	0810 80x600	0810 80x300

*The minimum order quantity is indicated.

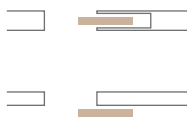
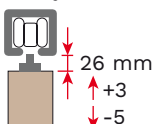
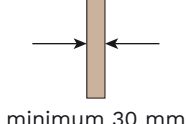
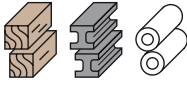
SYSTEM OUTDOOR 0830

<p>SLIDING Outdoor</p> 	<p>FIXING Standard single-entry bracket</p> 	<p>DOOR THICKNESS</p>  <p>minimum 30 mm</p>	<p>DOOR MATERIAL Wood, Metal and PVC</p> 	<p>SYSTEM LOAD CAPACITY Up to 175 kg</p> 	<p>ROLLERS Body: Zamak Wheels: 2 Pin: stainless steel</p> 
---	--	---	---	---	--



INDEX

A sliding set for Outdoor system 0830

Set	Load capacity	Door thickness	Sliding	Page
0830 3	175 kg	minimum 30 mm	Outdoor 	122
Tracks, Accessories and Spare parts 0830 3				123

Optional

System	Description	Item number.	Page
New Kit Klose	Self closing - outside the wall	0880 1	149
	Self closing - inside the wall	0880 2	150
2000	Parallel door sliding gear	2000	152

KIT 0830 3

Sliding door kit for outdoor and humid environment. Zamak roller, stainless steel pin, single-entry bracket, end stop. Load capacity 175 kg.

<p>SLIDING Outdoor</p>	<p>FIXING Standard single-entry bracket</p>	<p>DOOR THICKNESS</p> <p>minimum 30 mm</p>	<p>DOOR MATERIAL Wood, Metal and PVC</p>	<p>SYSTEM LOAD CAPACITY Up to 175 kg</p>	<p>ROLLERS Body: Zamak Wheels: 2 Pin: stainless steel</p>
-----------------------------------	--	---	---	---	--

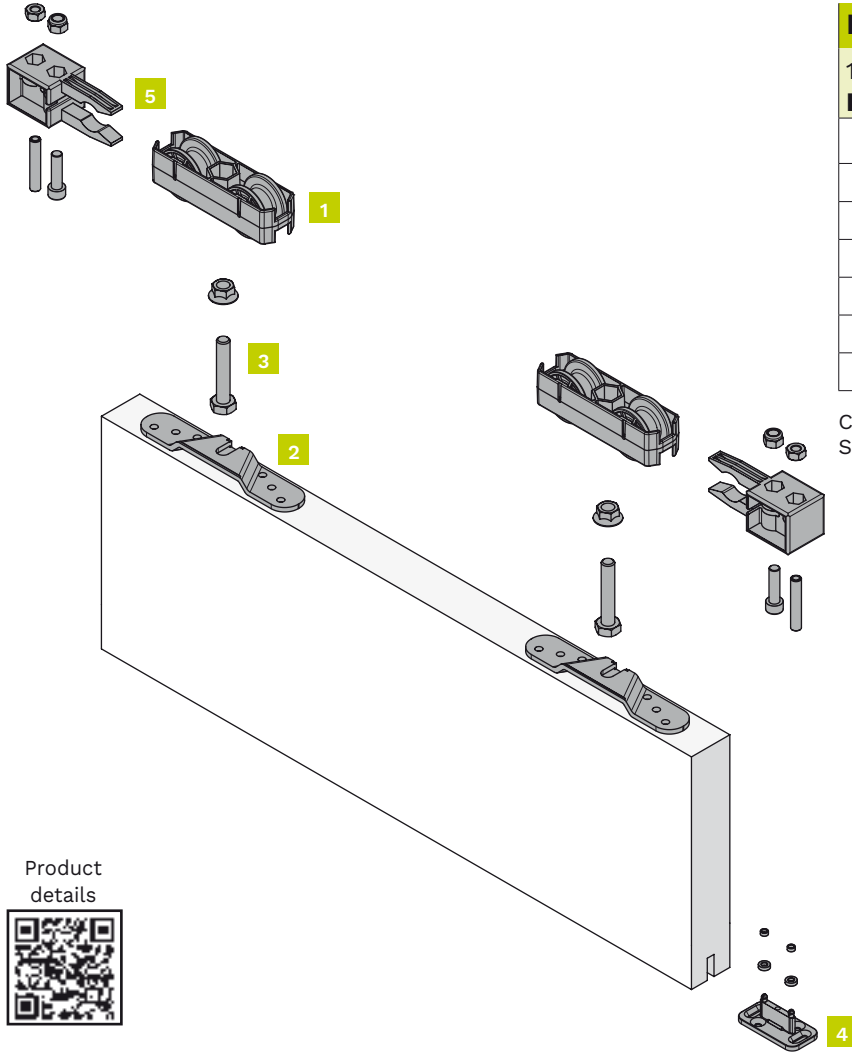

Kit components

1 door set

Item number: 0830 3

Figure	Component	Quantity
1	Upper roller - 175 kg	2 pieces
2	Single-entry bracket	2 pieces
3	Support screw for roller (hanger)	2 pieces
4	Adjustable lower guide	1 piece
5	End-stop	2 pieces
-	Valve seat wrench	1 piece

Complete the set in the section "Tracks, Accessories and Spare parts".

Product details



Technical drawings

Dimensions indicated in millimeters

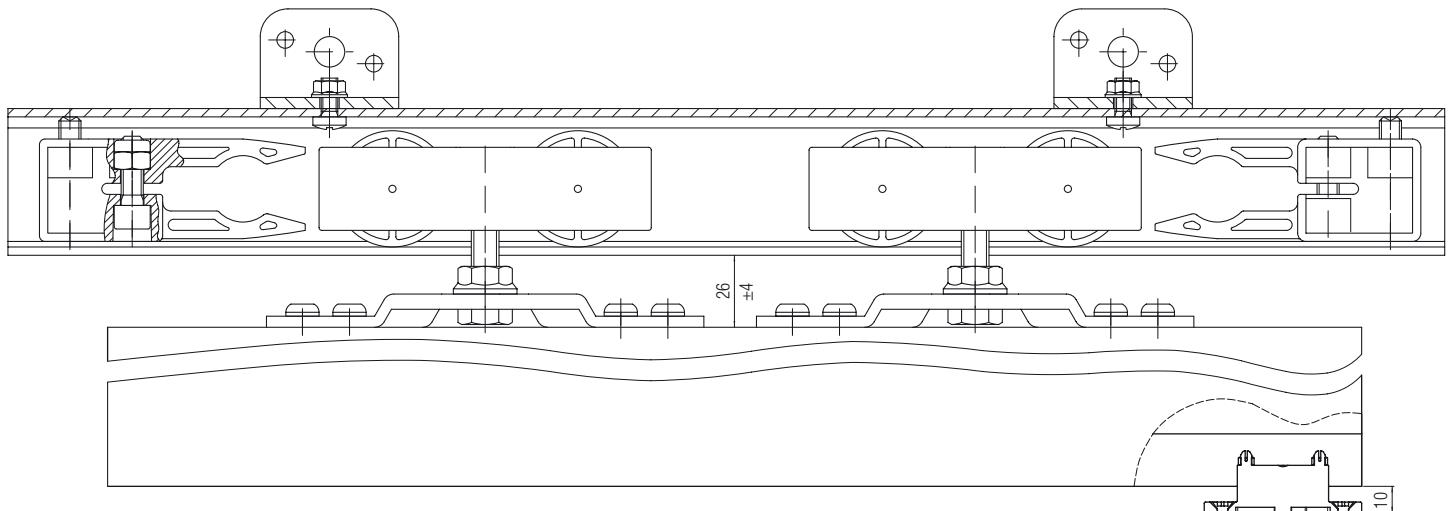

Tracks, Accessories and Spare parts 0830 3

Complete the kit with track and accessory according to application.

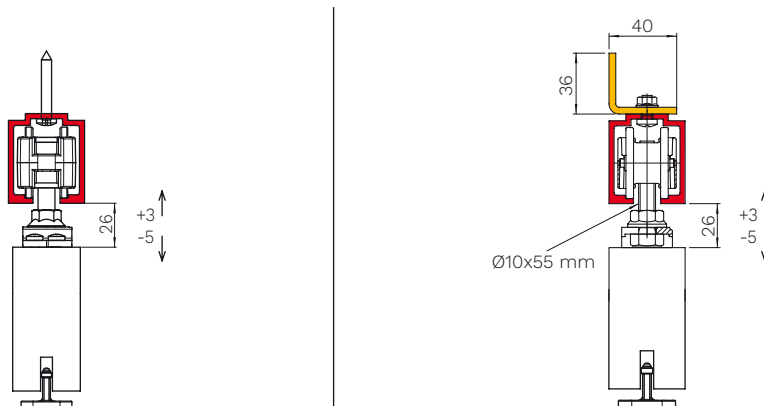
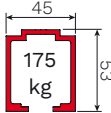
Installation examples	Dimensions tracks and accessories
<p>Dimensions indicated in millimeters</p> 	

Tracks

Drilled and anodised aluminium track - 175 kg	Item number.
3 meters	0830 2
6 meters	0830 1

Accessories



Component	Item number.
L shape wall fixing - 250 kg	0850 5

Spare parts

Component	*Quantity	Item number.	Which set is it for?
Upper roller - 175 kg	2 pieces	0830 53	0830 3
Single-entry bracket	2 pieces	0830 52	0830 3
Support screw for roller (hanger)	2 pieces	0830 51	0830 3
Adjustable lower guide	20 pieces	0500 13	0830 3
End-stop	2 pieces	0830 4	0830 3

*The minimum order quantity is indicated.

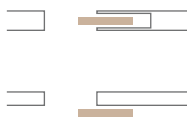
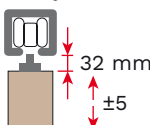
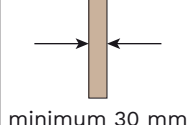
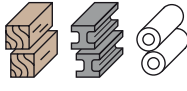
SYSTEM OUTDOOR 0850

<p>SLIDING Outdoor</p> 	<p>FIXING Standard single-entry bracket</p> 	<p>DOOR THICKNESS</p>  <p>minimum 30 mm</p>	<p>DOOR MATERIAL Wood, Metal and PVC</p> 	<p>SYSTEM LOAD CAPACITY Up to 250 kg</p> 	<p>ROLLERS Body: Aluminum Wheels: 2 Pin: stainless steel</p> 
---	--	---	---	---	---



INDEX

A sliding set for Outdoor system 0850



Set	Load capacity	Door thickness	Sliding	Page
0850 3	250 kg	minimum 30 mm	Outdoor 	126
Tracks, Accessories and Spare parts 0850 3				127

Optional

System	Description	Item number.	Page
New Kit Klose	Self closing - outside the wall	0880 1	149
	Self closing - inside the wall	0880 2	150
2000	Parallel door sliding gear	2000	152

KIT 0850 3

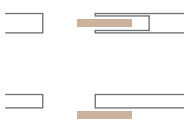
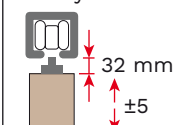
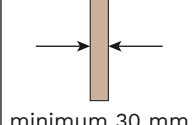
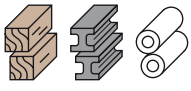
Sliding door kit for outdoor and humid environment. Aluminum roller, stainless steel pin, single-entry bracket, end stop. Load capacity 250 kg.

<p>SLIDING Outdoor</p> 	<p>FIXING Standard single-entry bracket</p> 	<p>DOOR THICKNESS</p> 	<p>DOOR MATERIAL Wood, Metal and PVC</p> 	<p>SYSTEM LOAD CAPACITY massimo 250 kg</p> 	<p>ROLLERS Body: Aluminum Wheels: 2 Pin: stainless steel</p> 
--	--	--	---	--	---

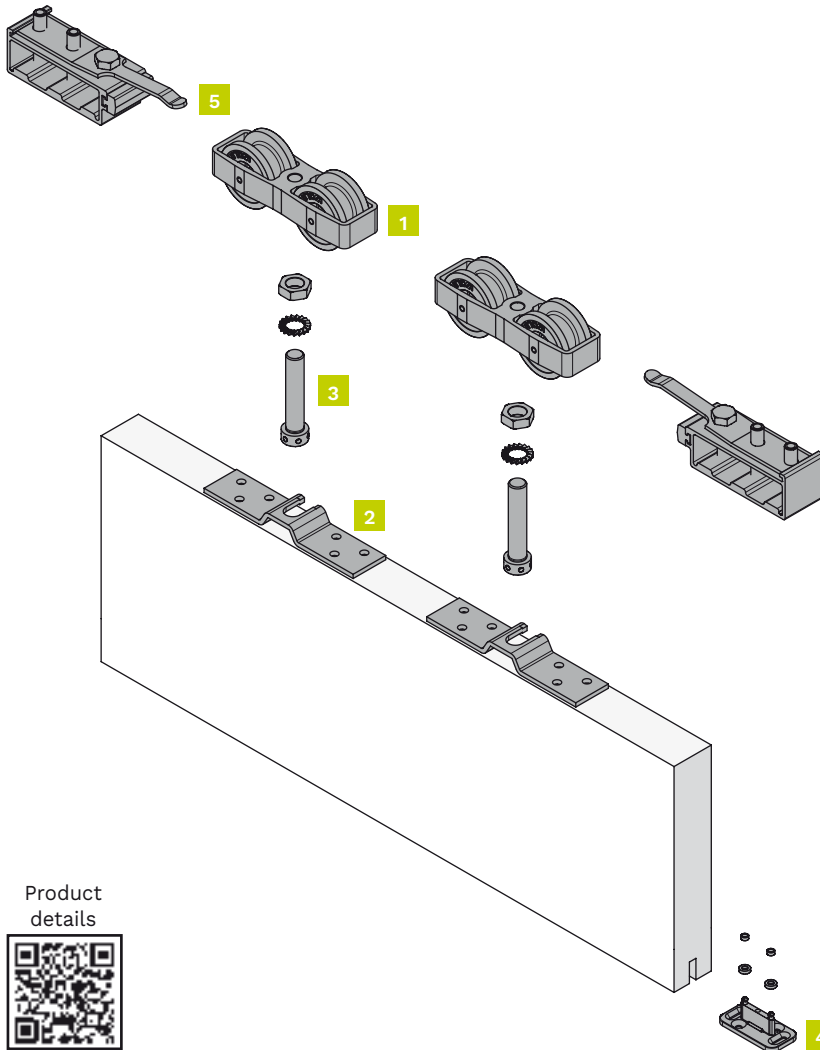

Kit components

1 door set
Item number: 0850 3

Figure	Component	Quantity
1	Upper roller - 250 kg	2 pieces
2	Single-entry bracket	2 pieces
3	Support screw for roller (hanger)	2 pieces
4	Adjustable lower guide	1 piece
5	End-stop	2 pieces
-	Valve seat wrench	1 piece

Complete the set in the section "Tracks, Accessories and Spare parts".

Product details



Technical drawings

Dimensions indicated in millimeters

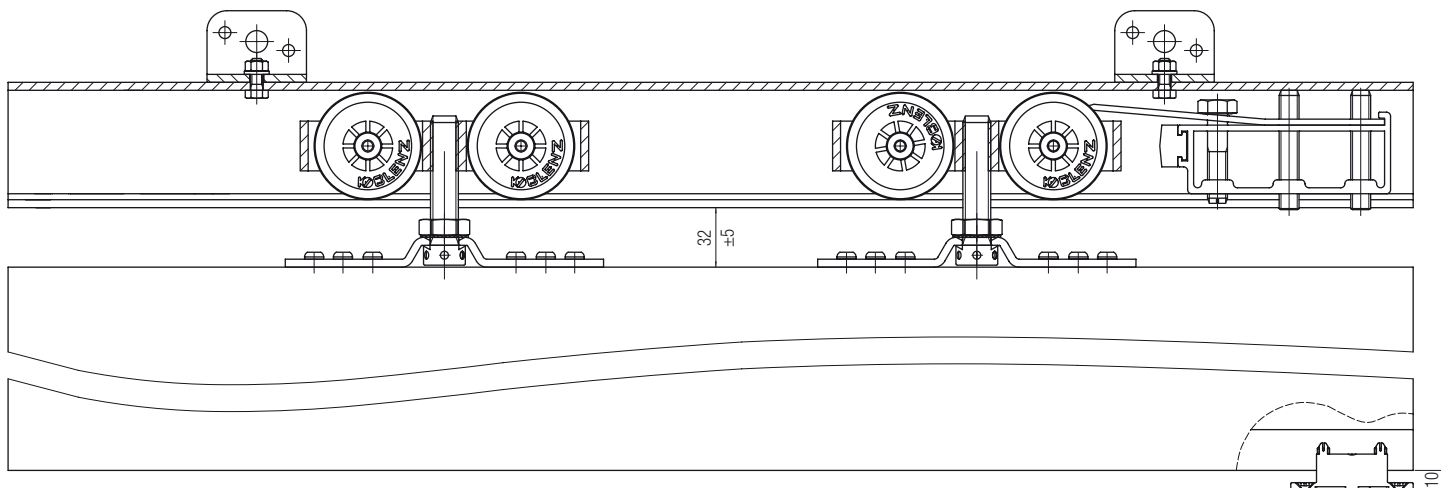

Tracks, Accessories and Spare parts 0850 3

Complete the kit with track and accessory according to application.

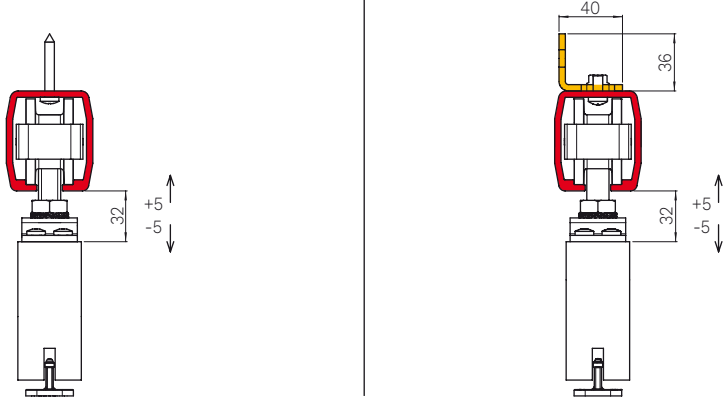
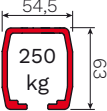
Installation examples	Dimensions tracks and accessories
<p>Dimensions indicated in millimeters</p> 	

Tracks

Anodised aluminium track - 250 kg	Item number.
3 meters	0850 2
6 meters	0850 1

Accessories

Component	Item number.
L shape wall fixing - 250 kg	0850 5

Spare parts

Component	*Quantity	Item number.	Which set is it for?
Upper roller - 250 kg	2 pieces	0850 53	0850 3
Single-entry bracket	2 pieces	0850 52	0850 3
Support screw for roller (hanger)	2 pieces	0850 51	0850 3
Adjustable lower guide	20 pieces	0500 13	0850 3
End-stop	1 piece	0850 4	0850 3

*The minimum order quantity is indicated.

DESIGN SERIES

Sliding systems for wooden
and glass doors





DESIGN SERIES

Design Series is made up of a wall mounted door set which perfectly expresses and mixes the concepts of **functionality** and **aesthetics**: with Tricks system the minimalism applied to the doors is enhanced, while with K20 the entire sliding system which is usually hidden gets highlighted.

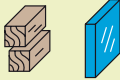
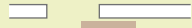

INDEX

System	Door material	Sliding	Page
Tricks		Invisible 	132
K20		Exposed 	136

TERMS AND DEFINITIONS

• DOOR MATERIAL



Wood



Glass

• SLIDING



Invisible

The solution that allows the creation of the wall mounted sliding doors with an invisible sliding system.







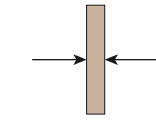

On view

The solution that allows the creation of the wall mounted sliding doors with a visible track and rollers. Suitable for wooden and glass doors.

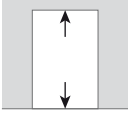
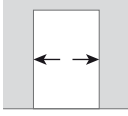
SYSTEM TRICKS

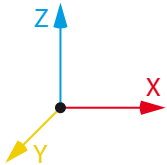
PATENTED

<p>SLIDING Invisible</p> 	<p>DOOR THICKNESS</p>  <p>minimum 40 mm</p>	<p>DOOR MATERIAL Wood</p> 	<p>SYSTEM LOAD CAPACITY Up to 50 kg</p> 	<p>WALL OPENING HEIGHT</p>  <p>maximum 2450 mm</p>	<p>WALL OPENING WIDTH</p>  <p>maximum 1200 mm</p>	<p>FLOOR WHEEL Missing</p> 
<p>3D ADJUSTMENTS</p> 	<p>ALSO SUITABLE FOR FURNITURE</p> 					

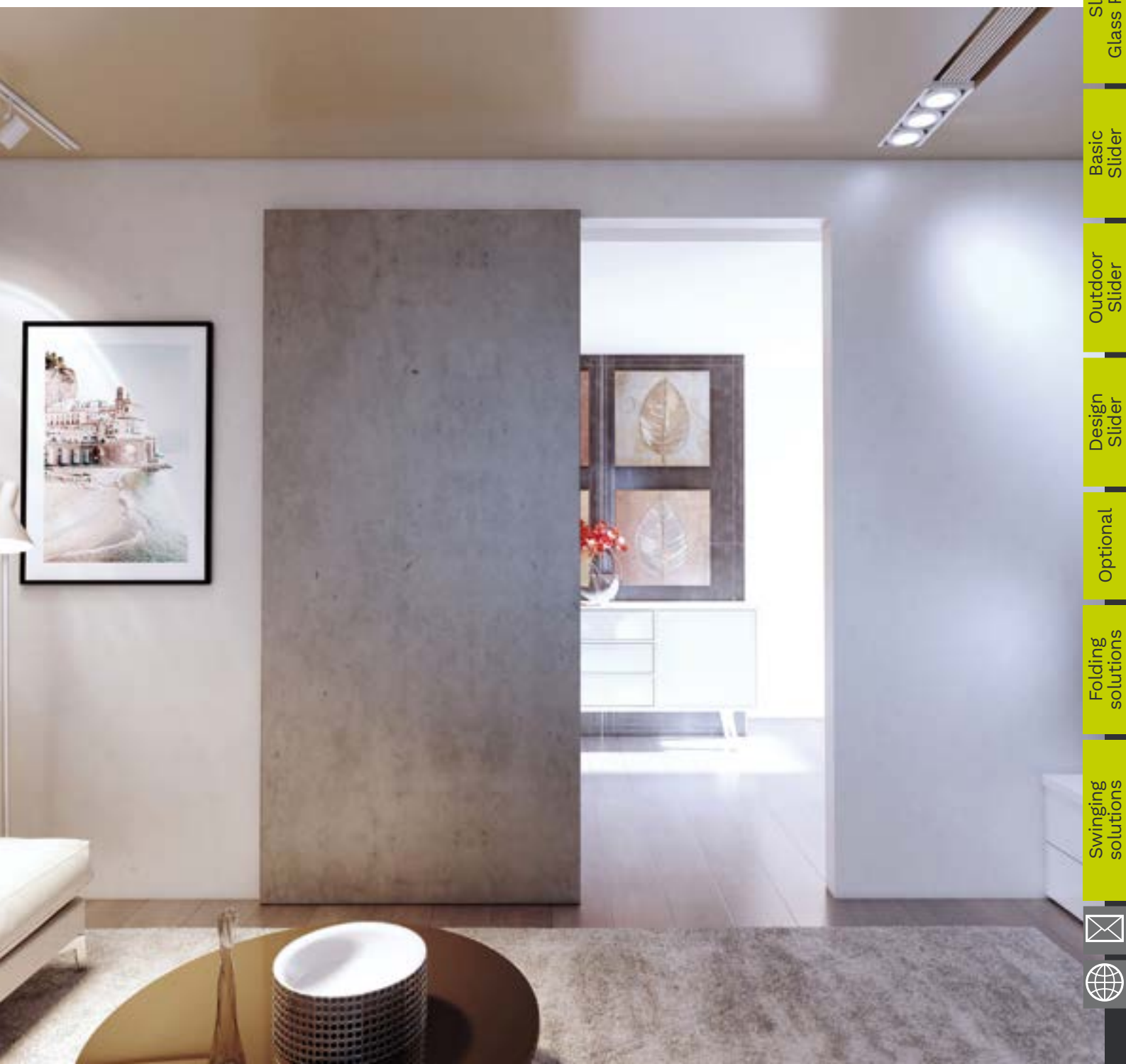

INDEX







A sliding set for Tricks system

Set	Load capacity	Door thickness	Sliding	Page
0590 1	50 kg	minimum 40 mm	Invisible 	134
Tracks, Accessories and Spare parts 0590 1				135

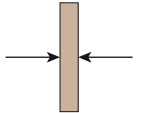

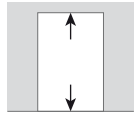
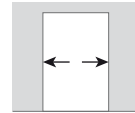
KIT 0590 1 - TRICKS

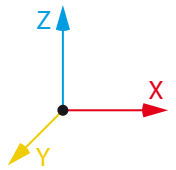
Invisible wall mount kit for sliding wooden doors. Crossed cable solution for perfect balance. No floor wheels. Only 10 mm lower light. 3D adjustment.

SLIDING Invisible 	DOOR THICKNESS  minimum 40 mm	DOOR MATERIAL Wood 	SYSTEM LOAD CAPACITY Up to 50 kg 	WALL OPENING HEIGHT  maximum 2450 mm	WALL OPENING WIDTH  maximum 1200 mm	FLOOR WHEEL Missing 
3D ADJUSTMENTS 	ALSO SUITABLE FOR FURNITURE 					

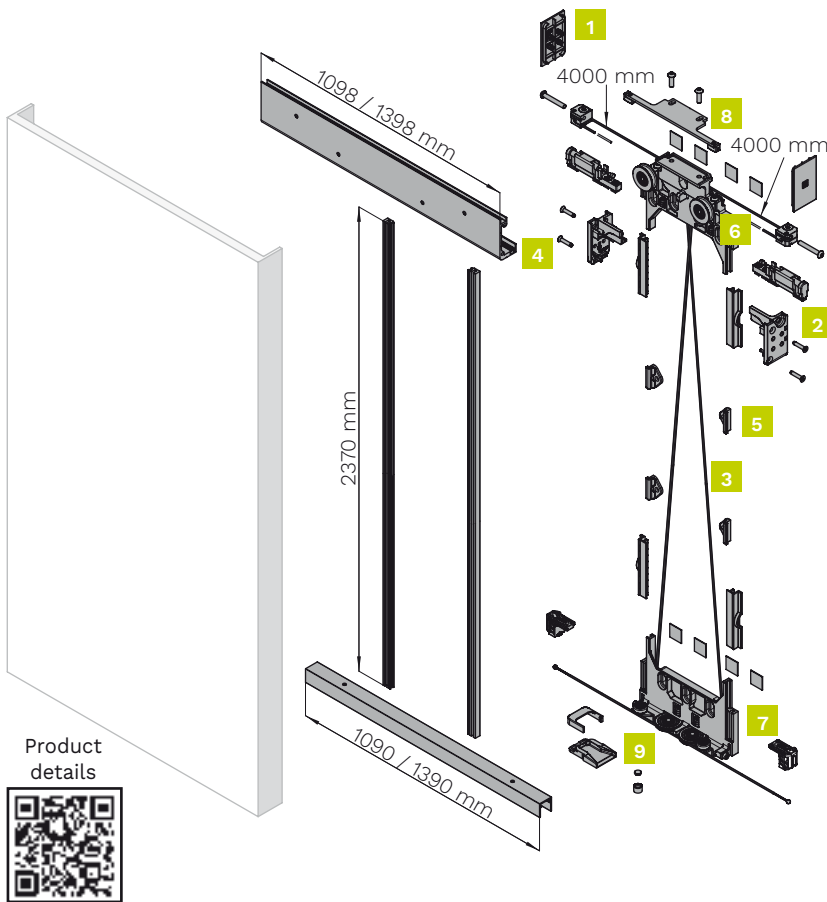

Kit components

1 door set
Item number: 0590 1

Figure	Component	Quantity
1	Kit with plastic components	1 piece
2	Kit damper	1 piece
3	Cable kit	1 piece
4	Upper brackets right and left	2 pieces
5	Cable stop upper clamps right and left	2 pieces
6	Upper roller	1 piece
7	Lower roller	1 piece
8	Anti-derailment safety bracket	1 piece
9	Lower guide	1 piece

Complete the set in the section "Tracks, Accessories and Spare parts".

Product details



Technical drawings

Dimensions indicated in millimeters

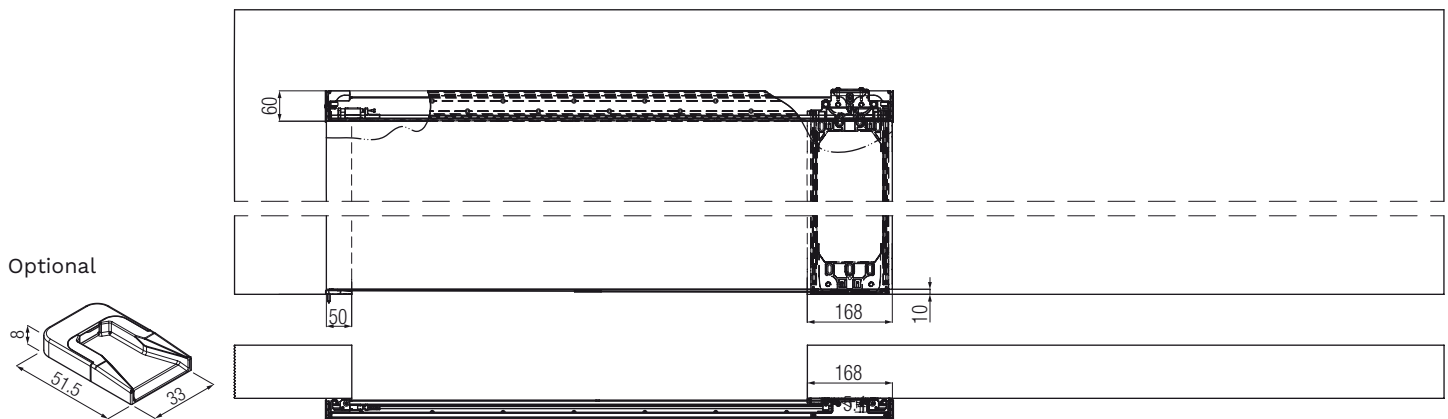

Optional

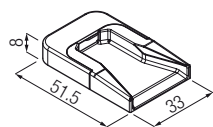

Tracks, Accessories and Spare parts 0590 1

Complete the kit with accessory according to application.

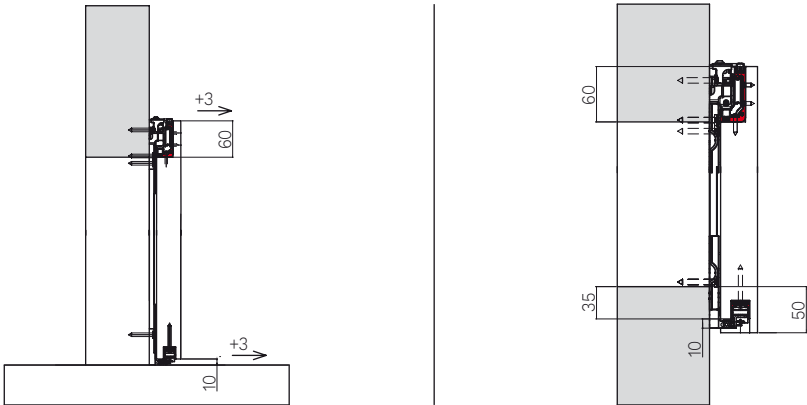
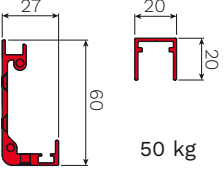
Installation examples	Dimensions tracks and accessories
<p>Dimensions indicated in millimeters</p> 	 <p>50 kg</p>

Accessories

Upper track, lower track and vertical connection uprights	Item number.
Aluminum profile Kit to cut for wall opening up to 900mm wide and up to 2450mm high	0590 900 2450
Aluminum profile kit to cut for wall opening up to 1200mm wide and up to 2450mm high	0590 1200 2450
Aluminum profile Kit "Pre-cut to size" for wall opening up to 1200mm wide and up to 2450mm high	0590 1200 2450 F.M.



Spare parts

Component	*Quantity	Item number.	Which set is it for?
Kit with plastic components	1 piece	0590 01	0590 1
Kit damper	2 pieces	0590 02	0590 1
Cable kit	2 pieces	0590 03	0590 1
Aluminum uprights	1 piece	0590 04	0590 1
Upper brackets right and left	2 pieces	0590 05	0590 1

*The minimum order quantity is indicated.

SYSTEM K20

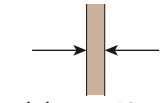
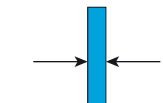
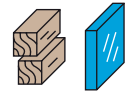
PATENTED

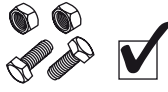
<p>SLIDING On view</p> 	<p>DOOR THICKNESS</p>  <p>minimum 40 mm maximum 46 mm</p>	<p>DOOR THICKNESS</p>  <p>10 mm</p>	<p>DOOR MATERIAL Wood, Glass</p> 	<p>SYSTEM LOAD CAPACITY Up to 120 kg</p> 	<p>ROLLERS Body: Zamak Wheels: 2 Ball bearings: 2</p> 	<p>FIXING SCREWS Included</p> 
--	---	---	---	--	--	--



Index

Terms

Slider
Wood Premium

Slider
Glass Premium

Basic
Slider

Outdoor
Slider

Design
Slider

Optional







Folding
solutions

Swinging
solutions







INDEX

A sliding set for K20 system

Set	Load capacity	Door thickness	Door material	Sliding	Number of door leaf	Page
K 20 4 CL	120 kg	minimum 40 mm maximum 46 mm		Exposed 	1	138
K 20 43 CL	120 kg	minimum 40 mm maximum 46 mm		Exposed 	2	139
Tracks, Accessories and Spare parts K 20 4 CL / K 20 43 CL						140
K 20 1 CL	120 kg	10 mm		Exposed 	1	141
Tracks, Accessories and Spare parts K 20 1 CL						142

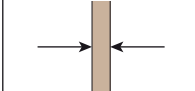
KIT K 20 4 CL

Invisible wall mount kit for sliding wooden doors. Crossed cable solution for perfect balance. No floor wheels. Only 10 mm lower light. 3D adjustment.

<p>SLIDING On view</p> 	<p>DOOR THICKNESS</p>  <p>minimum 40 mm maximum 46 mm</p>	<p>DOOR MATERIAL Wood</p> 	<p>SYSTEM LOAD CAPACITY Up to 120 kg</p> 	<p>ROLLERS Body: Zamak Wheels: 2 Ball bearings: 2</p> 	<p>FIXING SCREWS Included</p> 
--	---	--	---	---	--

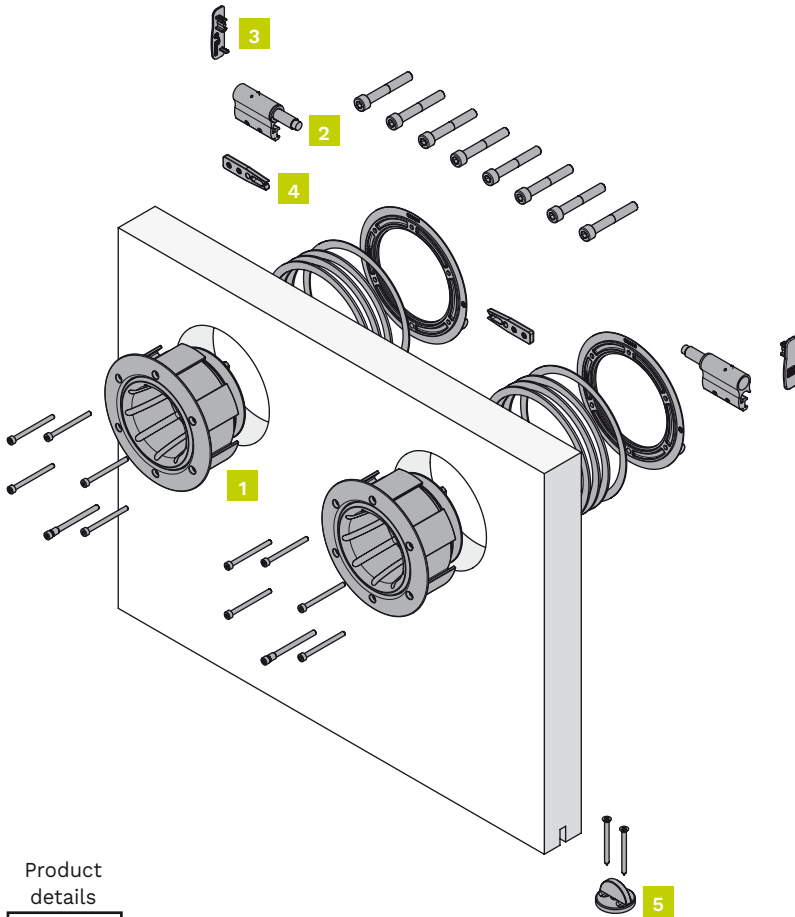

Kit components

1 door set

Item number: K 20 4 CL

Figure	Component	Quantity
1	Roller wood polished chrome	2 pieces
2	Wood-brake right-left polished chrome	2 pieces
3	Cap right-left polished chrome	1 piece
4	Block brake	2 pieces
5	Lower wood guide polished chrome	1 piece

Complete the set in the section "Tracks, Accessories and Spare parts".

Product details





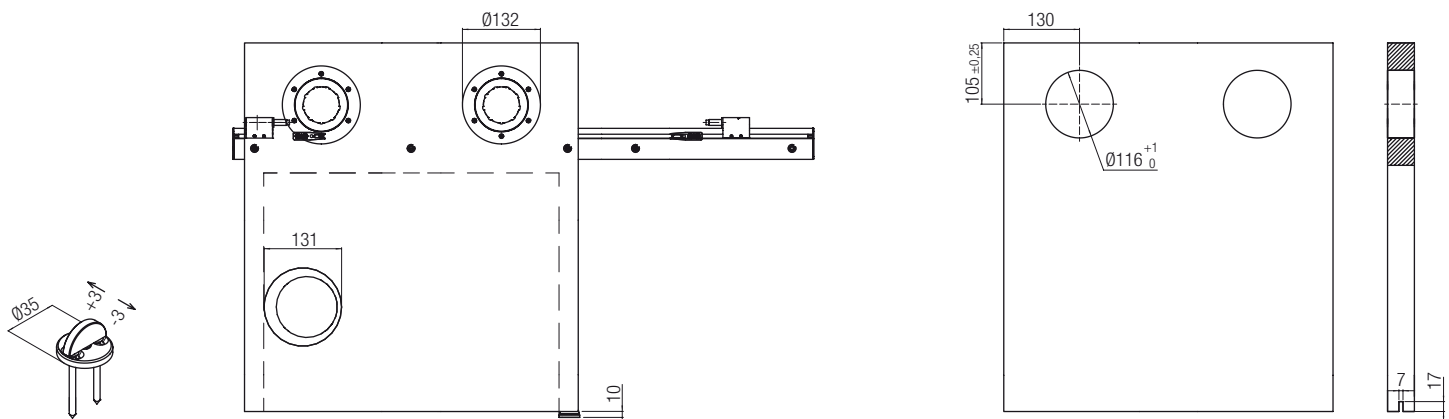

Technical drawings

Dimensions indicated in millimeters

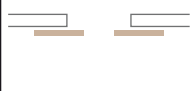
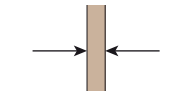

KIT K 20 43 CL

Two door kit for wall mount sliding doors. Shiny chrome Zamak roller. The kit is to be combined with the single door version (K 20 4 CL). Load capacity for two doors 120 kg.

SLIDING On view 	DOOR THICKNESS  minimum 40 mm maximum 46 mm	DOOR MATERIAL Wood 	SYSTEM LOAD CAPACITY Up to 120 kg 	ROLLERS Body: Zamak Wheels: 2 Ball bearings: 2 	FIXING SCREWS Included 
---	--	---	--	--	---

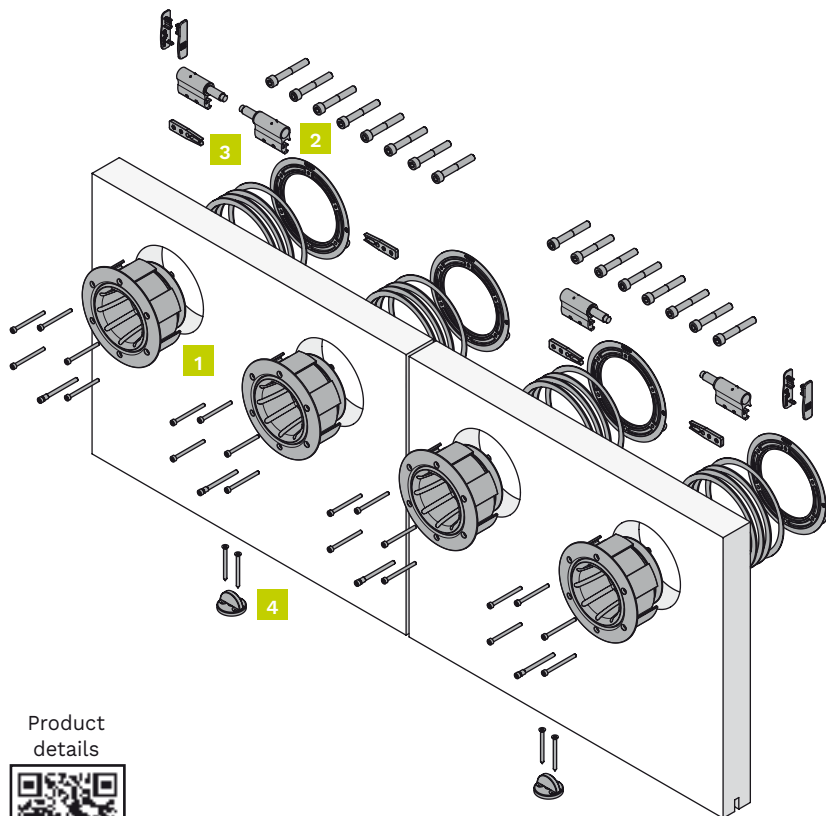

Kit components

A double door set*
Item number: K 20 43 CL

Figure	Component	Quantity
1	Roller wood polished chrome	2 pieces
2	Wood-brake right-left polished chrome	2 pieces
3	Block brake	2 pieces
4	Lower wood guide polished chrome	1 piece

*In order to make a double door it is necessary to purchase art. K 20 4 CL as well
 Complete the set in the section "Tracks, Accessories and Spare parts".



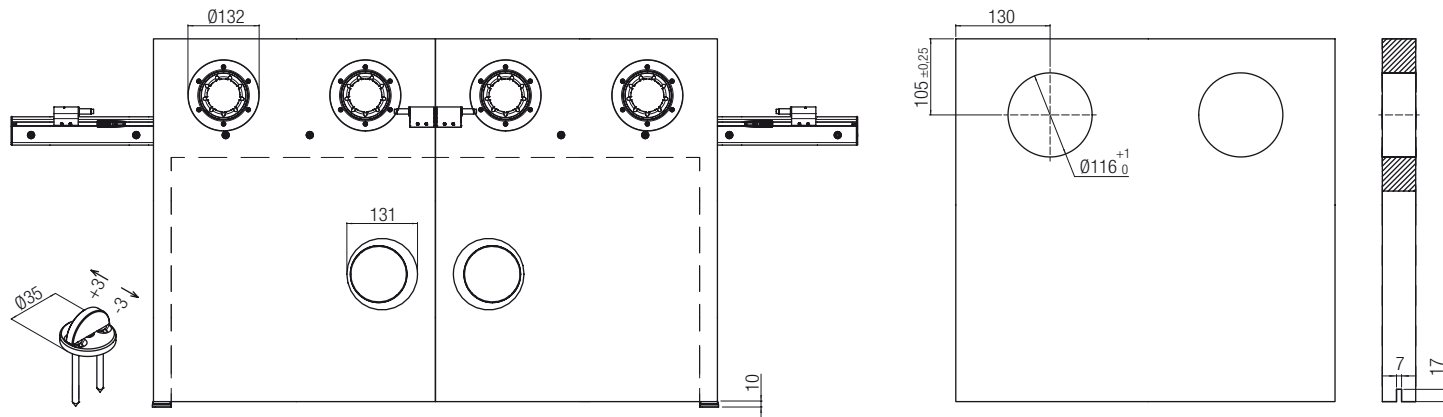

Technical drawings

Dimensions indicated in millimeters

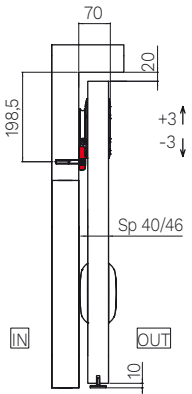

Tracks, Accessories and Spare parts K 20 4 CL / K 20 43 CL

Complet kit with track.

Installation examples	Dimensions tracks and accessories
<p>Dimensions indicated in millimeters</p> 	 <p>120 kg</p>





Tracks	
Anodised aluminium track - 120 kg	Item number.
1,73 meters	K 20 56 CL
2,13 meters	K 20 57 CL
2,732 meters	K 20 58 CL
3,332 meters	K 20 59 CL

- Index
- Terms
- Slider Wood Premium
- Slider Glass Premium
- Basic Slider
- Outdoor Slider
- Design Slider
- Optional
- Folding solutions
- Swinging solutions

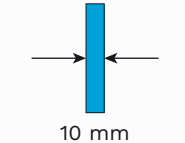

KIT K 20 1 CL

Single door kit for wall mount glass sliding doors. Shiny chrome Zamak roller. Load capacity 120 kg.

<p>SLIDING On view</p> 	<p>DOOR THICKNESS</p>  <p>10 mm</p>	<p>DOOR MATERIAL Glass</p> 	<p>SYSTEM LOAD CAPACITY Up to 120 kg</p> 	<p>ROLLERS Body: Zamak Wheels: 2 Ball bearings: 2</p> 	<p>FIXING SCREWS Included</p> 
--	---	---	---	---	--

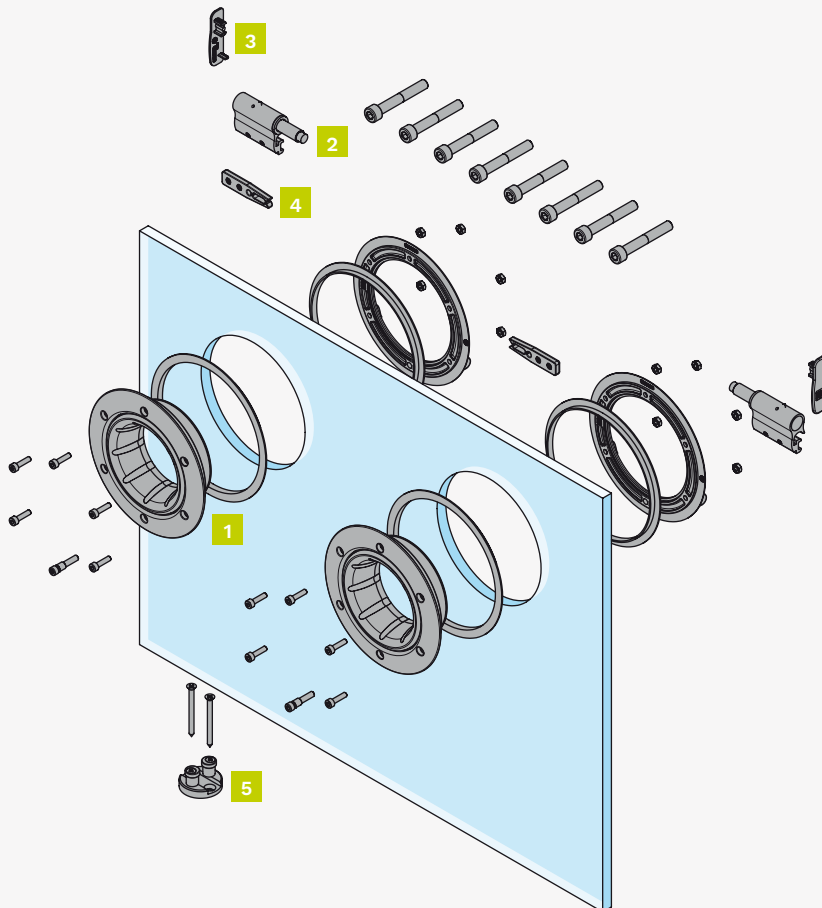

Kit components

1 door set

Item number: K 20 1 CL

Figure	Component	Quantity
1	Roller glass polished chrome	2 pieces
2	Wood-brake right-left polished chrome	2 pieces
3	Cap right-left polished chrome	1 piece
4	Block brake	2 pieces
5	Lower glass guide polished chrome	1 piece

Complete the set in the section "Tracks, Accessories and Spare parts".

Product details



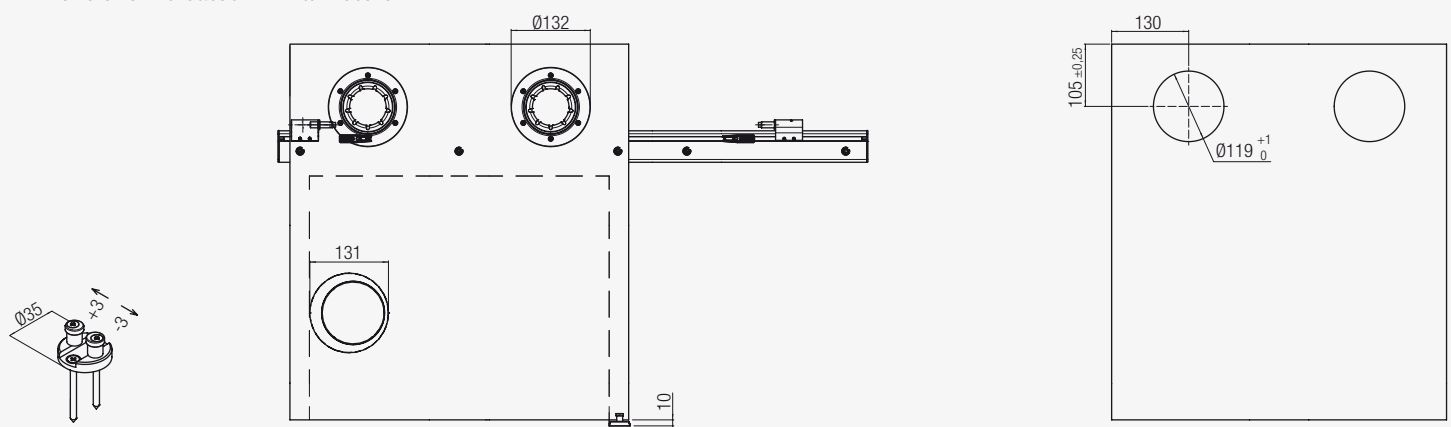

Technical drawings

Dimensions indicated in millimeters

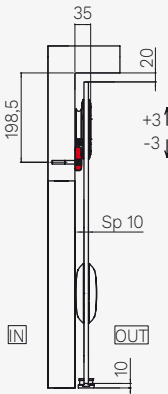

Tracks, Accessories and Spare parts K 20 1 CL

Complet kit with track.

Installation examples	Dimensions tracks and accessories
<p>Dimensions indicated in millimeters</p> 	 <p>120 kg</p>

Tracks	
Anodised aluminium track - 120 kg	Item number.
1,73 meters	K 20 56 CL
2,13 meters	K 20 57 CL
2,732 meters	K 20 58 CL
3,332 meters	K 20 59 CL

Spare parts			
Component	*Quantity	Item number.	Which set is it for?
Lower glass guide polished chrome	1 piece	7550 12 CL	K 20 1 CL

*The minimum order quantity is indicated.

Optional



Index

Terms

Slider
Wood Premium

Slider
Glass Premium

Basic
Slider

Outdoor
Slider

Design
Slider

Optional

Folding
solutions

Swinging
solutions





INDEX

Set	Load capacity	Description	Page
0860 1	40 kg	Soft close device - Single ABS - 40 kg	146
0860 80	80 kg	Soft close device - Single ABS - 80 kg	147
0880 1 - NEW KIT KLOSE	80 kg	Self closing - Outside the wall	149
0880 2 - NEW KIT KLOSE	80 kg	Self closing - Inside the wall	150
2000	-	Parallel door sliding gear	152

KIT 0860 1

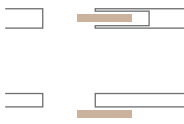
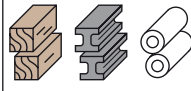
Universal kit with a single ABS soft closing. Plastic housing, minimum door leaf width 710 mm, fixed braking activator. Load capacity 40 kg.

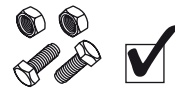
<p>SLIDING</p> 	<p>DOOR MATERIAL Wood, Metal and PVC</p> 	<p>SYSTEM LOAD CAPACITY Up to 40 kg</p> 	<p>FIXING SCREWS Fixing screws Included</p> 	<p>SOFT-CLOSE</p> <p>ABS ●●●●●●●●</p> <p>SINGLE Type: Mechanic Covering: Plastic Door leaf width: minimum 710 mm</p>
--	---	--	--	--

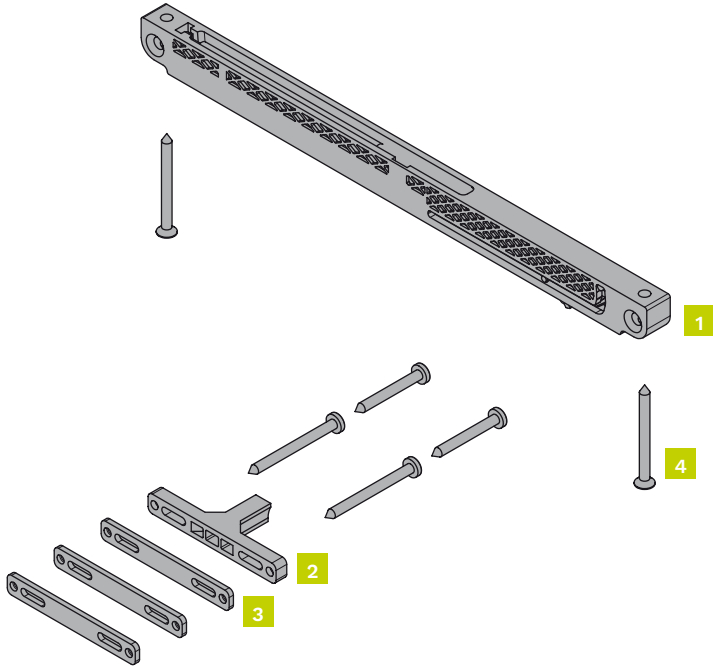

Kit components

1 door set
Item number: **0860 1**

Figure	Component	Quantity
1	Soft close device (single ABS) - 40 kg	1 piece
2	Activator ABS	1 piece
3	Activator spacer	5 pieces
4	Screw kit	1 piece

It can be used with:

Item number.	
0500 2	0400 3
0500 3	0400 4
0500 20	040040 160
0500 21	040040 200
0500 30	040040 230
0500 31	040040 300
0800 3	040080 150
0810 80x300	040080 200
0830 3	040080 230
0850 3	040080 300

Product details



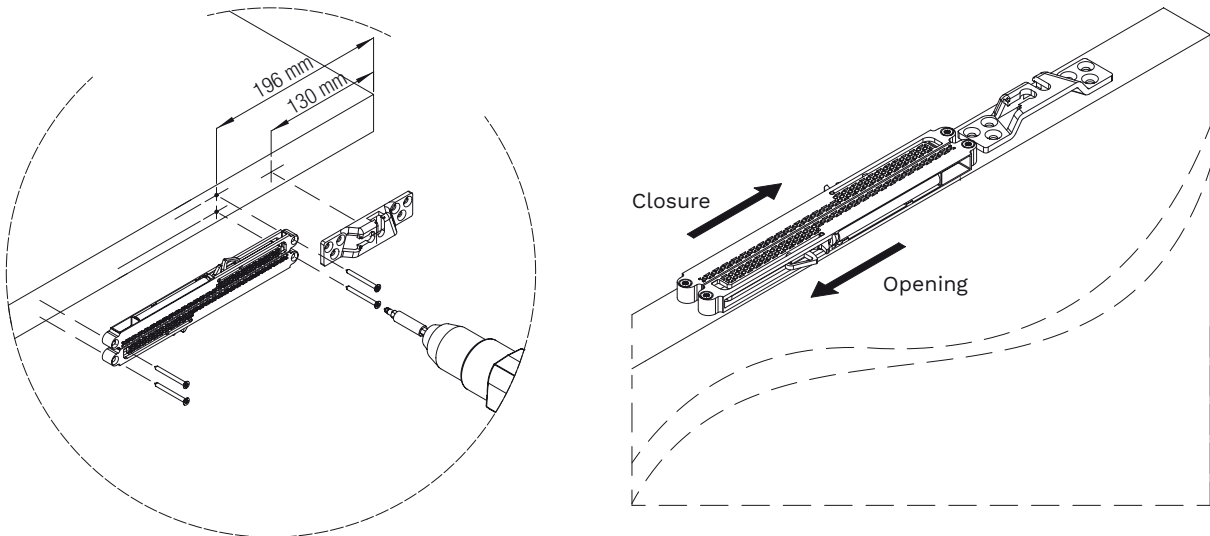

Technical drawings

Dimensions indicated in millimeters

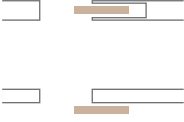
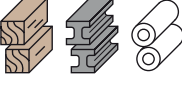

KIT 0860 80

Universal kit with a single ABS soft closing. Zamak housing, minimum door leaf width 710 mm, fixed braking activator. Load capacity 80 kg.

<p>SLIDING</p> 	<p>DOOR MATERIAL Wood, Metal and PVC</p> 	<p>SYSTEM LOAD CAPACITY Up to 80 kg</p> 	<p>FIXING SCREWS Fixing screws Included</p> 	<p>SOFT-CLOSE</p> <p>ABS ●●●●●●●●</p> <p>SINGLE Type: Mechanic Covering: Plastic Door leaf width: minimum 710 mm</p>
--	---	--	--	--

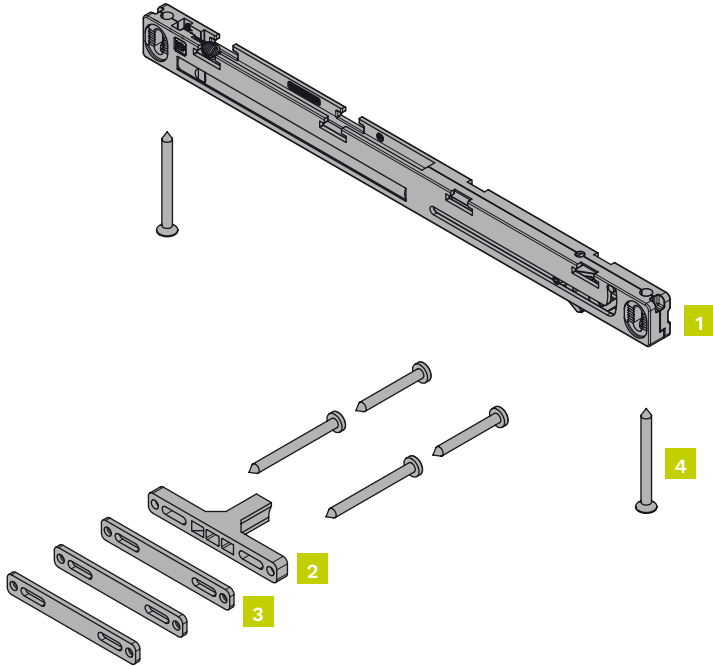

Kit components

1 door set
Item number: 0860 80

Figure	Component	Quantity
1	Soft close device (single ABS) - 80 kg	1 piece
2	Activator ABS	1 piece
3	Activator spacer	5 pieces
4	Screw kit	1 piece

It can be used with:

Item number.	
0500 2	0400 3
0500 3	0400 4
0500 20	040040 160
0500 21	040040 200
0500 30	040040 230
0500 31	040040 300
0800 3	040080 150
0810 80x300	040080 200
0830 3	040080 230
0850 3	040080 300

Technical drawings

Dimensions indicated in millimeters

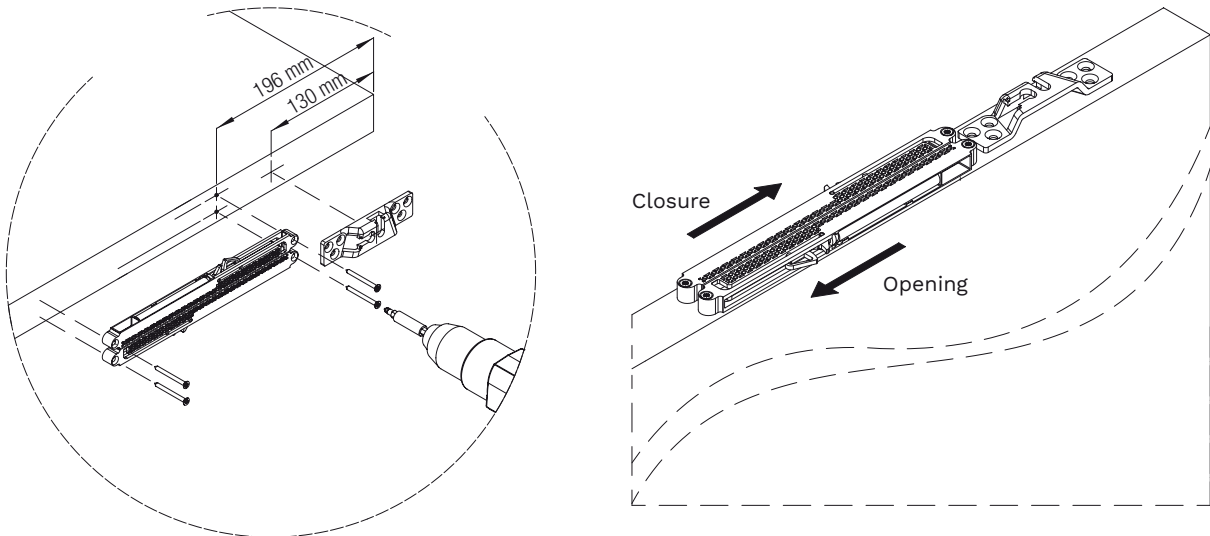





Spare parts kit 0860 1 / 0860 80

Spare parts			
Component	*Quantity	Item number.	Which set is it for?
Activator ABS Single - standard	1 piece	0860 2	0860 1 / 0860 80
Activator ABS Single - for flush doors	1 piece	0860 5	0860 1 / 0860 80
Activator spacer	1 piece	0860 6	0860 1 / 0860 80
Soft close device (single ABS) - 40 kg	1 piece	0860 7	0860 1
Soft close device (single ABS) - 80 kg	1 piece	0860 8	0860 80

*The minimum order quantity is indicated.

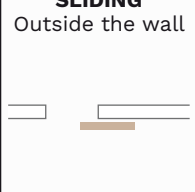
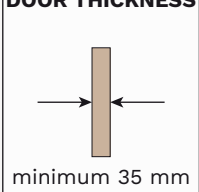
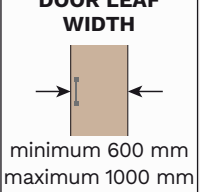
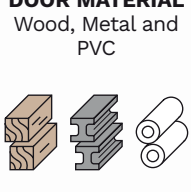
KIT 0880 1 - NEW KIT KLOSE

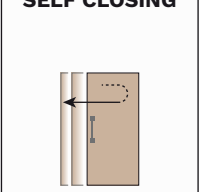
Automatic closing kit. Compatible with sliding door kits, it makes the wall mount door close automatically. Door leaf width between 600 and 1000 mm. Load capacity 80 kg.

SLIDING Outside the wall 	DOOR THICKNESS  minimum 35 mm	DOOR LEAF WIDTH  minimum 600 mm maximum 1000 mm	DOOR MATERIAL Wood, Metal and PVC 	SYSTEM LOAD CAPACITY Up to 80 kg 	SELF CLOSING 	FIXING SCREWS Fixing screws included 
--	---	--	--	--	--	---

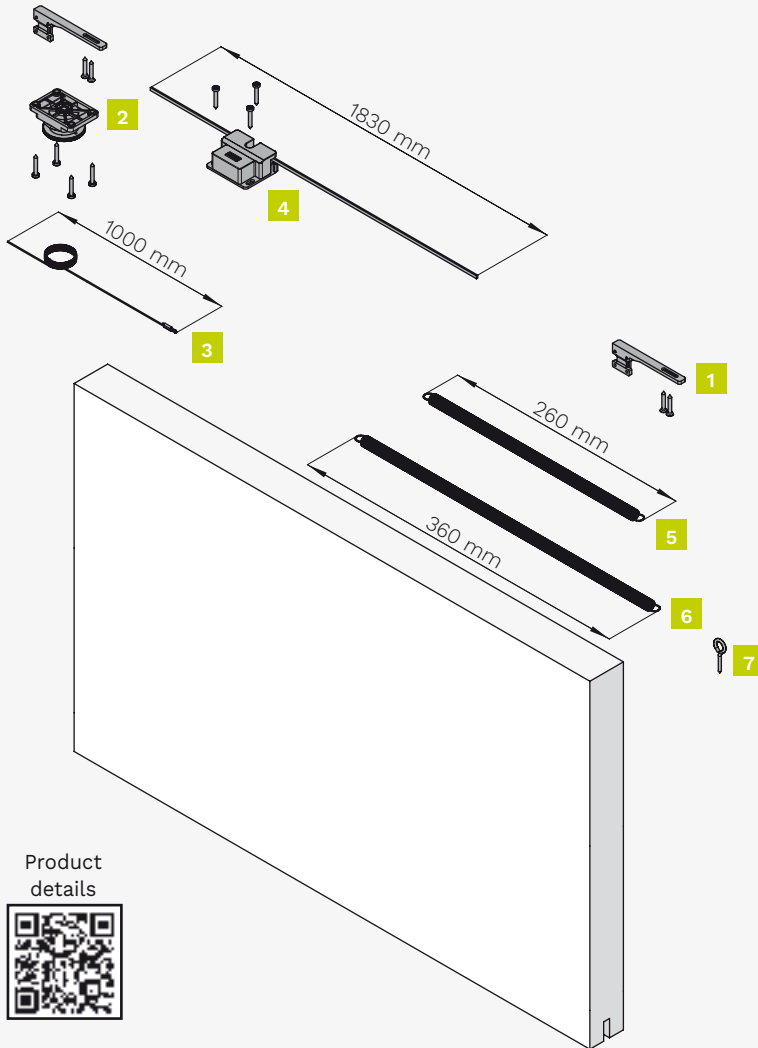

Kit components

1 door set
Item number: 0880 1

Figure	Component	Quantity
1	Strap clamp	2 pieces
2	Preload	1 piece
3	Cable (to connect with the spring)	1 piece
4	Slowdown device	1 piece
5	Short spring (doors up to 750 mm)	1 piece
6	Long spring (doors over 750 mm)	1 piece
7	Eyelet (for spring fixing)	1 piece

It can be used with:

Item number.	
0500 2	040040 230
0500 3	040040 300
0500 20	040080 150
0500 21	040080 200
0500 30	040080 230
0500 31	040080 300
0400 3	0800 3
0400 4	0810 80x300
040040 160	0830 3
040040 200	0850 3



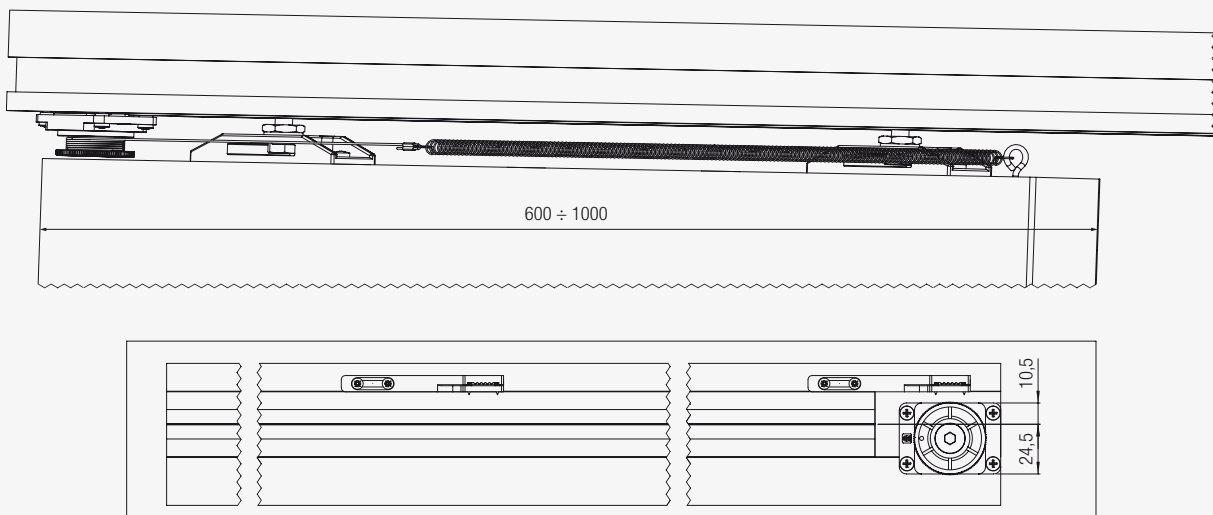

Technical drawings

Dimensions indicated in millimeters

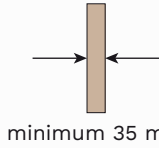
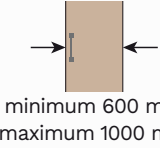
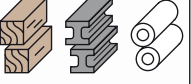

KIT 0880 2 - NEW KIT KLOSE

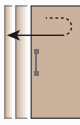
Automatic closing kit. Compatible with sliding door kits, it makes the pocket door close automatically. Door leaf width between 600 and 1000 mm. Load capacity 80 kg.

SLIDING Inside the wall 	DOOR THICKNESS  minimum 35 mm	DOOR LEAF WIDTH  minimum 600 mm maximum 1000 mm	DOOR MATERIAL Wood, Metal and PVC 	SYSTEM LOAD CAPACITY Up to 80 kg 	SELF CLOSING 	FIXING SCREWS Fixing screws included 
---	--	---	--	--	--	---

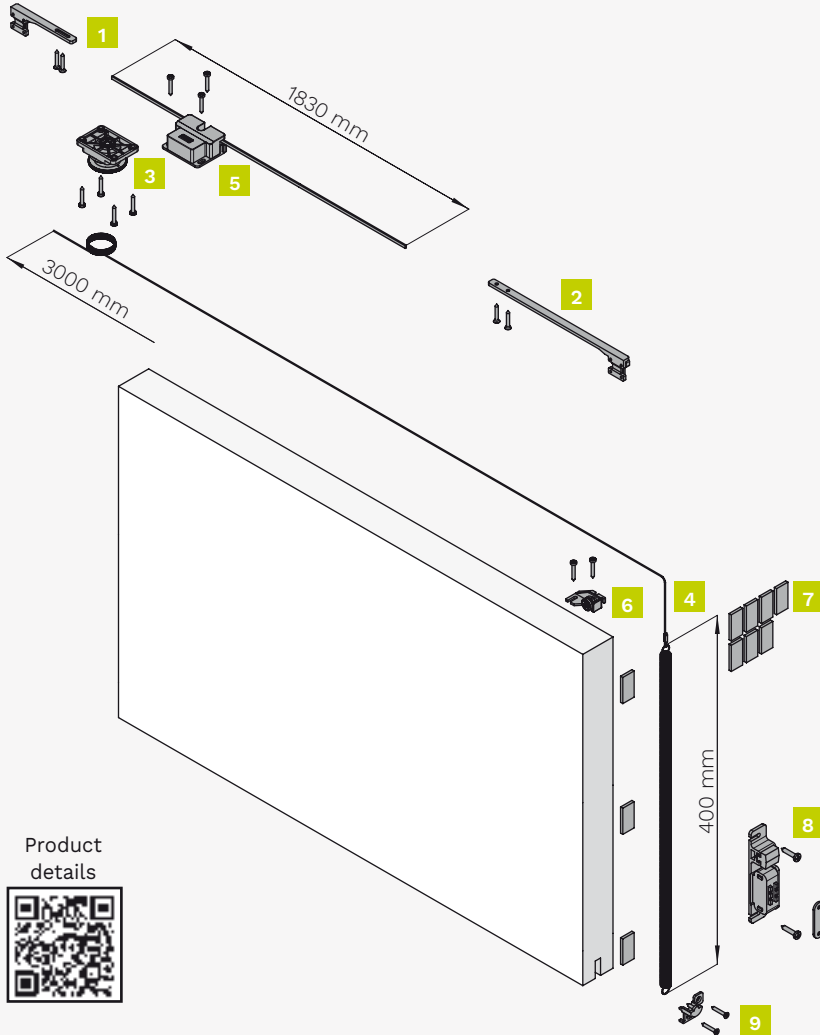

Kit components

1 door set
Item number: 0880 2

Figure	Component	Quantity
1	Strap clamp (closing side)	1 piece
2	Strap clamp (opening side)	1 piece
3	Preload	1 piece
4	Cable (to connect with the spring)	1 piece
5	Slowdown device	1 piece
6	Return pulley	1 piece
7	Rear rubber kit	1 piece
8	Magnetic device for door locking	1 piece
9	Lower spring stop	1 piece

It can be used with:

Item number.	
0500 2	040040 230
0500 3	040040 300
0500 20	040080 150
0500 21	040080 200
0500 30	040080 230
0500 31	040080 300
0400 3	0800 3
0400 4	0810 80x300
040040 160	0830 3
040040 200	0850 3

Technical drawings

Dimensions indicated in millimeters

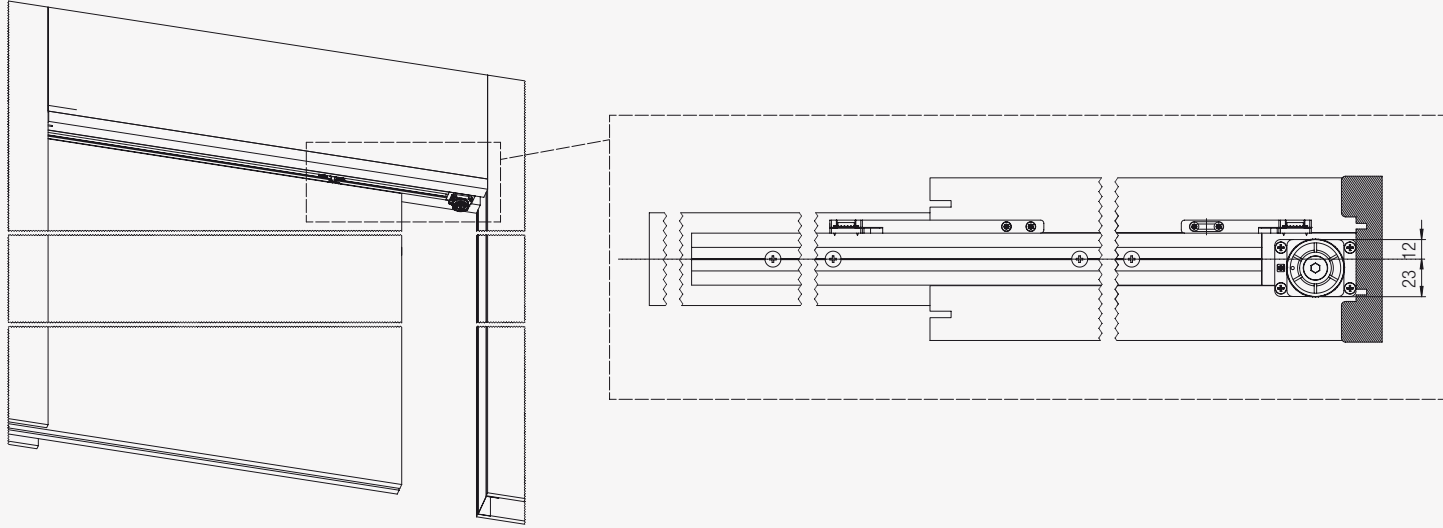

Tracks, Accessories and Spare parts 0880 1 / 0880 2

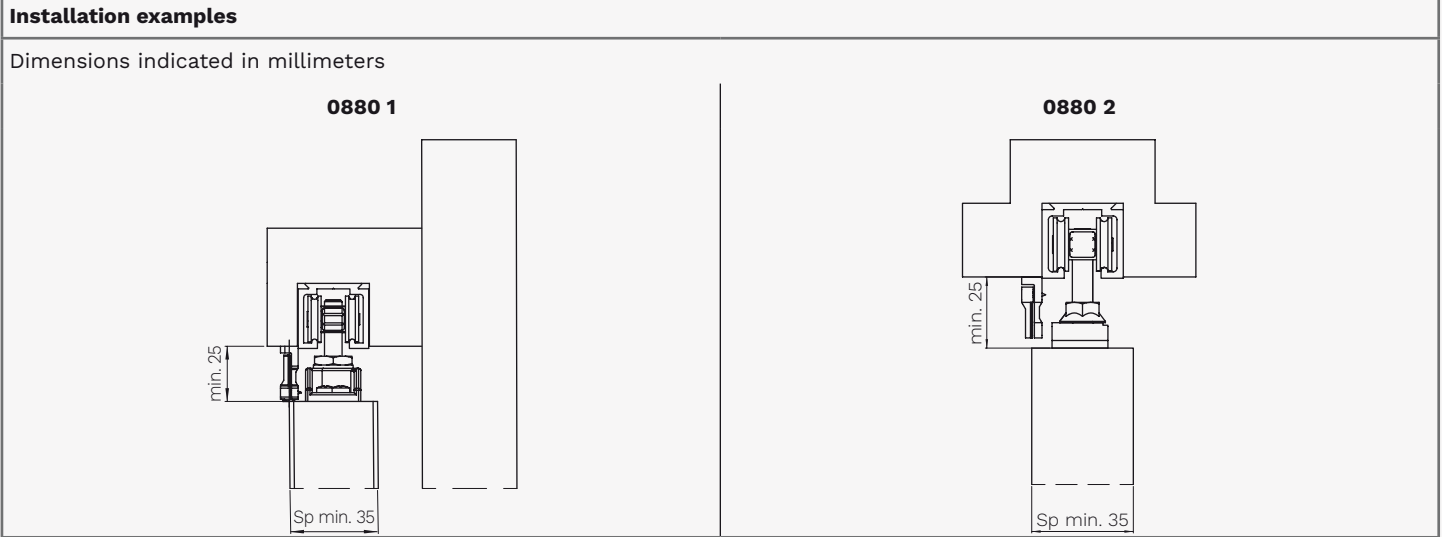

Spare parts



Component	*Quantity	Item number.	Which set is it for?
**Cable (to connect with the spring) 400 mm	1 piece	0880 9	0880 1 / 0880 2
Eyelet (for spring fixing)			
Rear rubber kit			

*The minimum order quantity is indicated.

**Only for set 0880 1: to cut at 260 mm length for doors up to 750 mm and at 360 mm length for doors over 750 mm.

KIT 2000

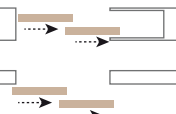
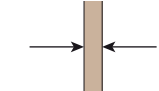
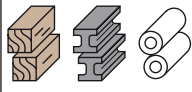
Universal parallel sliding door kit. Compatible with sliding door kits, it provides parallel doors application for pocket doors and wall mount doors with at least 2 door leaves.

SLIDING Telescopic doors 	DOOR THICKNESS  minimum 35 mm maximum 52 mm	DOOR MATERIAL Wood, Metal and PVC 	NUMBER OF DOOR LEAF  minimum 2
--	--	--	--

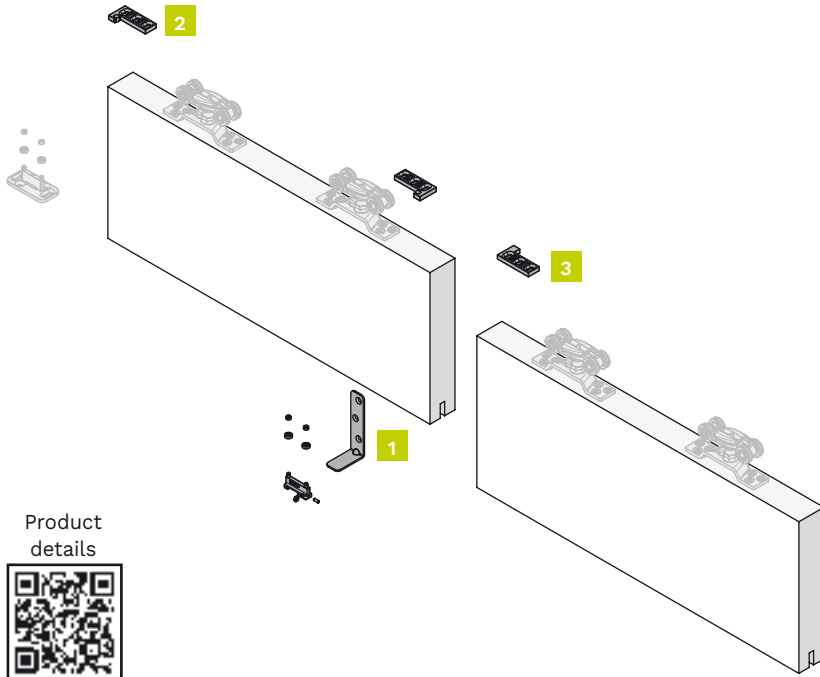

Kit components

1 door set
Item number: 2000

Figure	Component	Quantity
1	Adjustable lower guide - Fixed to the door	1 piece
2	Upper clamp "A"	2 pieces
3	Upper clamp "B"	1 piece
-	Valve seat wrench	1 piece

It can be used with:

Item number.	
0500 2	040040 300
0500 3	040080 150
0500 20	040080 200
0500 21	040080 230
0500 30	040080 300
0500 31	0450 3
0400 3	0450 4
0400 4	0800 3
040040 160	0810 80x300
040040 200	0830 3
040040 230	0850 3

Technical drawings

Dimensions indicated in millimeters

2 doors: 1 kit

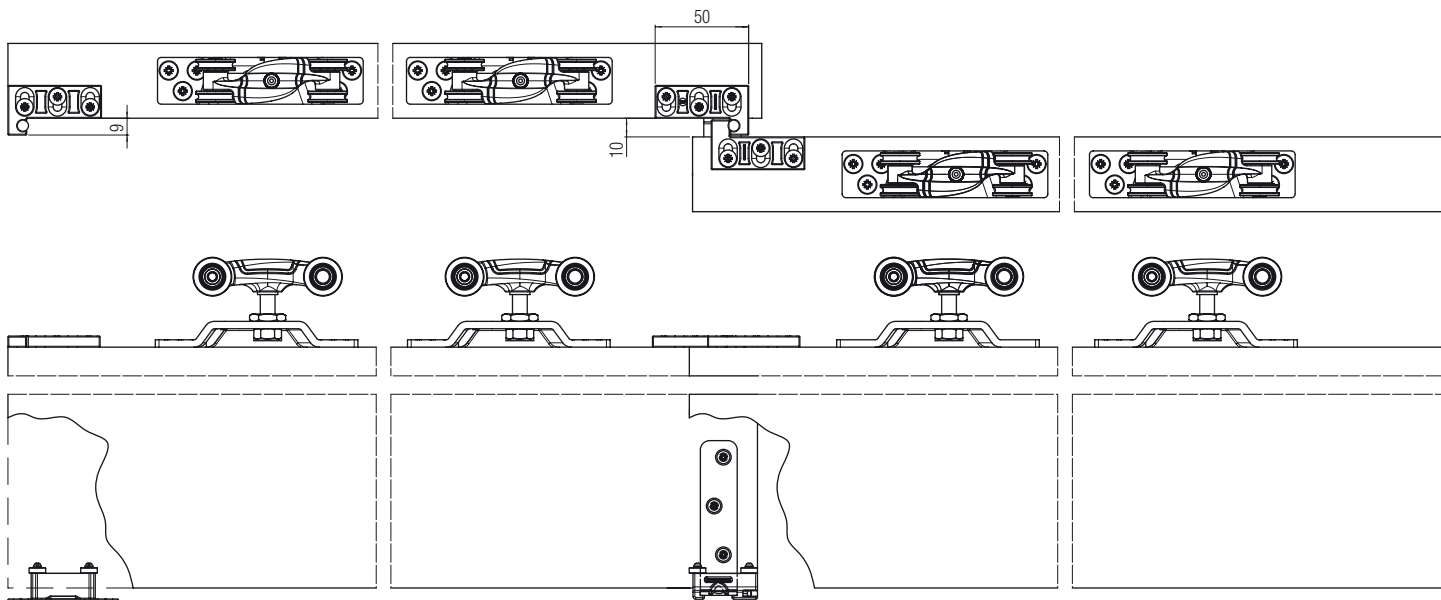

Tracks, Accessories and Spare parts 2000

Installation examples

Dimensions indicated in millimeters

2 doors: 1 kit

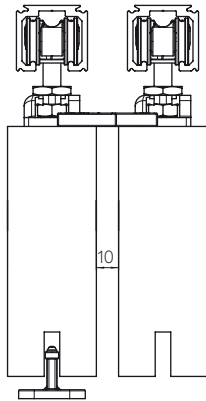

3 doors: 2 kit

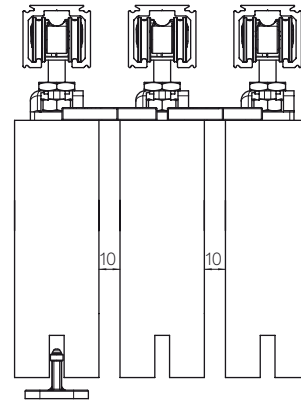

How many sets to install

2 doors → 1 kit

3 doors → 2 kit

4 doors → 3 kit

5 doors → 4 kit

6 doors → 5 kit

Spare parts

Component	*Quantity	Item number.	Which set is it for?
Adjustable lower guide - Fixed to the door	1 piece	2000 51	2000

*The minimum order quantity is indicated.

FOLDING DOOR SYSTEMS











FOLDING DOOR SYSTEMS

Folding doors represent the ideal solution for optimizing space and creating flexible environment. Thanks to their foldable nature, the folding door systems allow you to reduce the occupied space and to make the most of it.

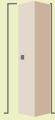
When the door is open, the small shutters close side by side, creating more space thanks to this compact solution.

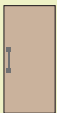
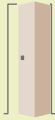
The Krona Koblenz folding systems offer two space options when the door is open: they can stay completely within one room or be divided in half, with one part in one room and the other part in the other. This versatility allows you to create a visual separation in the space, keeping an open and functional connection between the two parts.

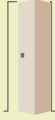

System	Folding	Space occupied	Number of door leaf per side	Page
0260	External shutter (External hinge) 	All in one room 	 2	158
0200	Flush (Inside hinge) 	All in one room  Both rooms 	 2	162
0700	Flush (Inside hinge) 	Both rooms 	 2-3-4-5-6-7-8	172
0710	Flush (Inside hinge) 	All in one room 	 2-4-6-8	178

TERMS AND DEFINITIONS

• FOLDING

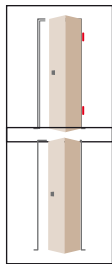

External shutter (External hinge)

Hinged doors. With this application the hinge is installed outside of the jamb.

Flush to wall (Internal hinge)

When the door is closed, it is flush to the wall. In this case the hinge is installed inside the jamb.

• OVERALL DIMENSIONS WHEN OPEN

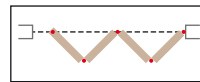

Totally in the same room

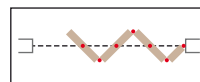

The space occupied by the opened doors is totally in the same room.



Both rooms

The space occupied by the opened doors is half-divided in 2 rooms.

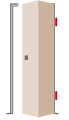
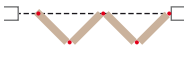
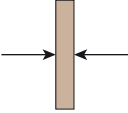

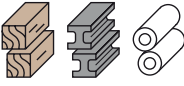

SYSTEM 0260

<p>FOLDING External shutter (External hinge)</p> 	<p>SPACE OCCUPIED All in one room</p> 	<p>DOOR THICKNESS</p>  <p>46 mm</p>	<p>NUMBER OF DOOR LEAF</p>  <p>2</p>	<p>SYSTEM LOAD CAPACITY Up to 50 kg</p> 	<p>DOOR MATERIAL Wood, Metal and PVC</p> 
---	--	---	--	--	---



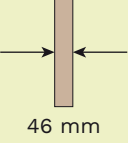





INDEX

A sliding set for system 0260

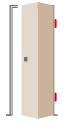
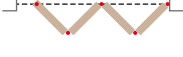
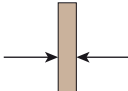
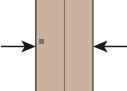
Set	Load capacity	Door thickness	Folding	Space occupied	Number of door leaf	Page
0260	50 kg	 46 mm	External shutter (External hinge) 	All in one room 	 2	160
Tracks, Accessories and Spare parts 0260						161

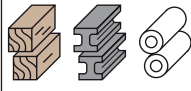
KIT 0260

Folding door kit. Rebating application and space occupied: all in one room. Installation with 2 doors. Load capacity 50 kg.

FOLDING External shutter (External hinge) 	SPACE OCCUPIED All in one room 	DOOR THICKNESS  *46 mm	DOOR LEAF WIDTH  2 shutters maximum 1000 mm	NUMBER OF DOOR LEAF  2	DOOR MATERIAL Wood, Metal and PVC 	SYSTEM LOAD CAPACITY Up to 50 kg 
HINGE COLOR Black or nickel 	INCLUDED IN THE KIT Drilled aluminium track  1000 mm					

*For smaller thickness get in touch with Krona Koblenz to ask for feasibility.

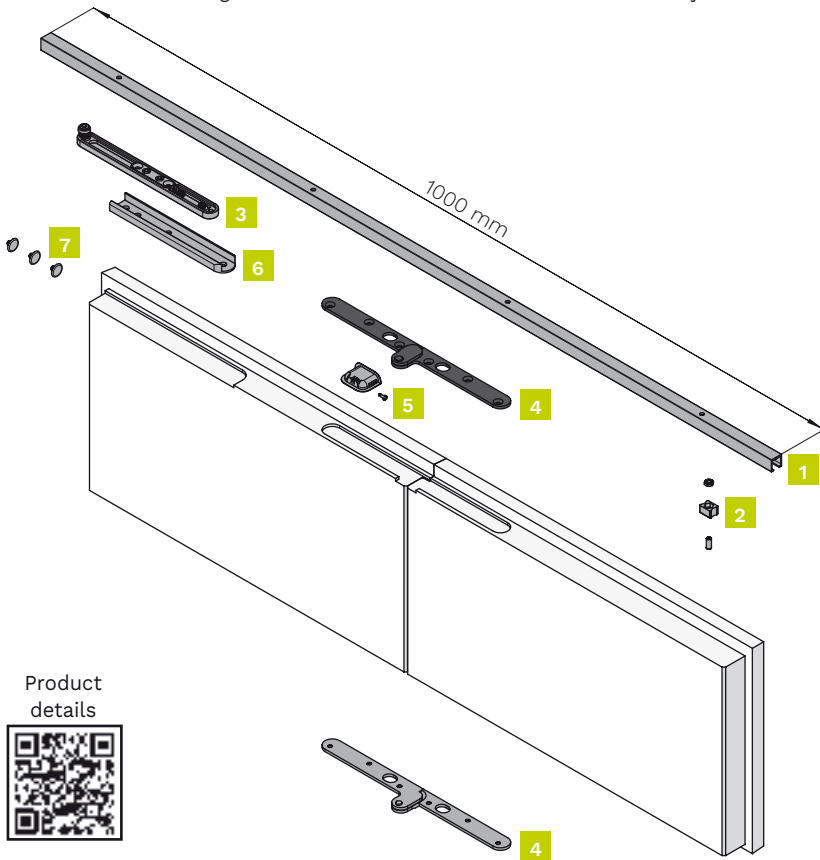

Kit components

2 doors set
Item number: 0260 1 DXSX (black hinge)
Item number: 0260 1.1 DX (nickel hinge)

Figure	Component	Quantity
1	Drilled aluminium track - 1 meter	1 piece
2	Stop brake	1 piece
3	Opening mechanism	1 piece
4	Upper/lower hinge (black or nickel)	2 pieces
5	Upper bracket housing	1 piece
6	Opening mechanism housing	1 piece
7	Stud cover (1x white, 1x black, 1x brown)	1 piece

Note: door/jamb connecting hinges are not included in the set.

Product details



Technical drawings

Dimensions indicated in millimeters

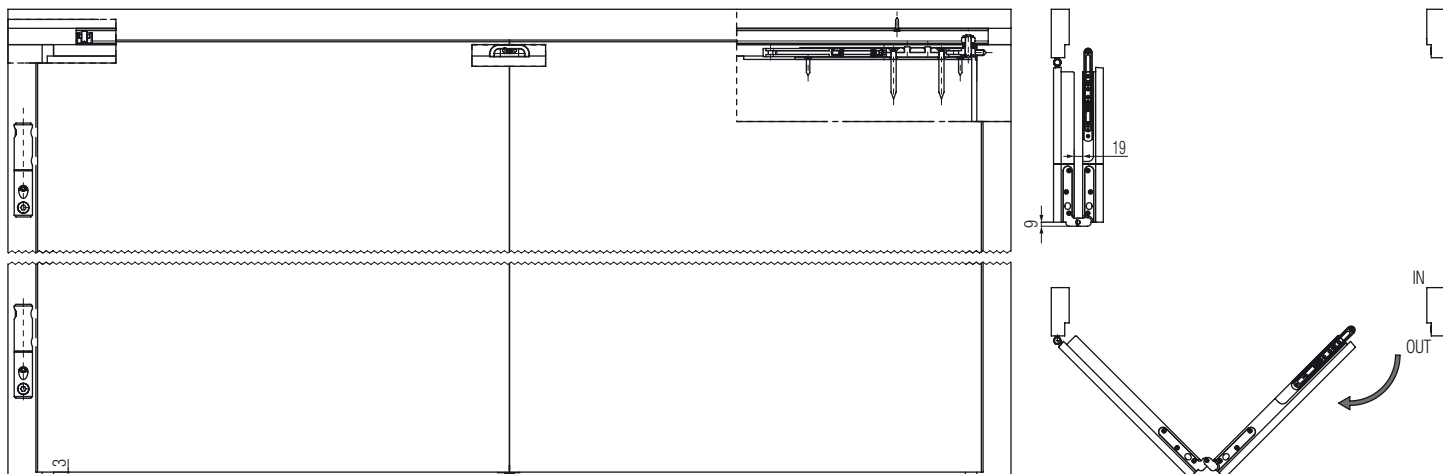

Tracks, Accessories and Spare parts 0260 1 DXSX / 0260 1.1 DX



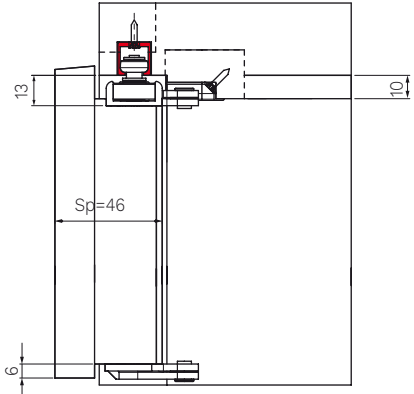
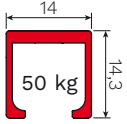



In order to have a complete set, you must purchase drill-in hinges separately.

Installation examples	Dimensions tracks and accessories
<p>Dimensions indicated in millimeters</p>  <p>Sp= Door thickness</p>	 <p>50 kg</p>

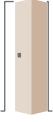
Spare parts			
Component	*Quantity	Item number.	Which set is it for?
Stop brake	1 piece	0260 56	0260 1 DXSX / 0260 1.1 DX
Opening mechanism	1 piece	0260 55	0260 1 DXSX / 0260 1.1 DX
Upper/Lower bracket nickel	2 pieces	0260 53 DXSX	0260 1.1 DX
Upper/Lower bracket black	2 pieces	0260 53 N DXSX	0260 1 DXSX
White upper bracket housing	1 piece	0260 51 BI	0260 1 DXSX / 0260 1.1 DX
Black upper bracket housing	1 piece	0260 51 NR	0260 1 DXSX / 0260 1.1 DX
Opening mechanism housing	1 piece	0260 52	0260 1 DXSX / 0260 1.1 DX
Stud cover (2x white, 2x black, 2x brown)	1 piece	0260 57	0260 1 DXSX / 0260 1.1 DX
Drilled aluminium track - 50 kg - 2 meters	10 pieces	0260 3	0260 1 DXSX / 0260 1.1 DX

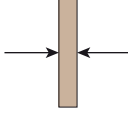
*The minimum order quantity is indicated.

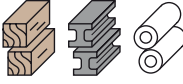









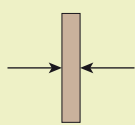
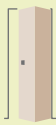



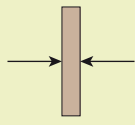
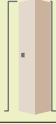

SYSTEM 0200

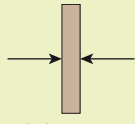
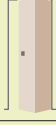
<p>FOLDING Flush (Inside hinge)</p> 	<p>SPACE OCCUPIED</p> <p>All in one room Both rooms</p> 	<p>DOOR THICKNESS</p>  <p>minimum 35 mm</p>	<p>NUMBER OF DOOR LEAF</p>  <p>2</p>	<p>DOOR MATERIAL Wood, Metal and PVC</p> 	<p>SYSTEM LOAD CAPACITY Up to 50 kg</p> 
<p>ROLLERS Roller: Nylon Wheels: POM</p> 					



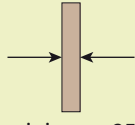
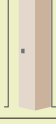



INDEX

A sliding set for system 0200

Set	Load capacity	Door thickness	Folding	Space occupied	Number of door leaf	Characteristics	Page
0200 1	50 kg	 minimum 35 mm	Flush (Inside hinge) 	All in one room  Both rooms 	 2	Includes 1m track	164
0200 4	50 kg	 minimum 35 mm	Flush (Inside hinge) 	All in one room  Both rooms 	 2	-	165
Tracks, Accessories and Spare parts 0200 1 / 0200 4							166
0200 1.1	50 kg	 minimum 35 mm	Flush (Inside hinge) 	All in one room  Both rooms 	 2	Includes 1m track	167
Tracks, Accessories and Spare parts 0200 1.1							168
0200 5	50 kg	 minimum 35 mm	Flush (Inside hinge) 	All in one room  Both rooms 	 2	-	169
Tracks, Accessories and Spare parts 0200 5							170

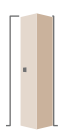
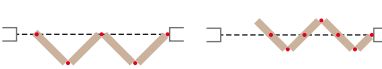
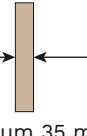
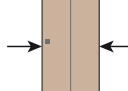
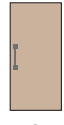
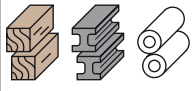
KIT 0200 1

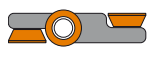
Folding door kit with a 1-meter track included. Flush-wall application and space occupied: all in one room or both rooms. Installation with 2 equal or unequal doors. Load capacity 50 kg.

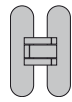
FOLDING Flush (Inside hinge) 	SPACE OCCUPIED All in one room Both rooms 	DOOR THICKNESS  minimum 35 mm	DOOR LEAF WIDTH  2 shutters maximum 1000 mm	NUMBER OF DOOR LEAF  2	DOOR MATERIAL Wood, Metal and PVC 
SYSTEM LOAD CAPACITY Up to 50 kg 	ROLLERS Roller: Nylon Wheels: POM 	INCLUDED IN THE KIT Black drilled and anodized track  1000 mm	OPTIONAL Concealed hinge 		

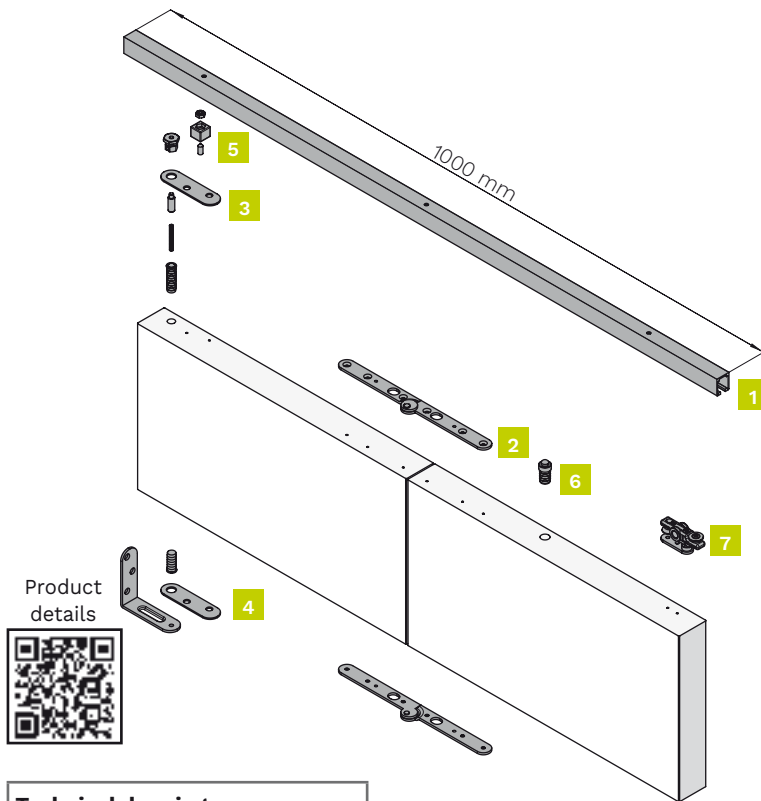

Kit components

2 doors set

Item number: 0200 1

Figure	Component	Quantity
1	Black drilled and anodized track - 1 meter	1 piece
2	Upper/Lower central bracket	2 pieces
3	Upper side hinge	1 piece
4	Lower side hinge	1 piece
5	End stop	1 piece
6	Stop brake	1 piece
7	Roller	1 piece

Technical drawings

Dimensions indicated in millimeters

Folding door

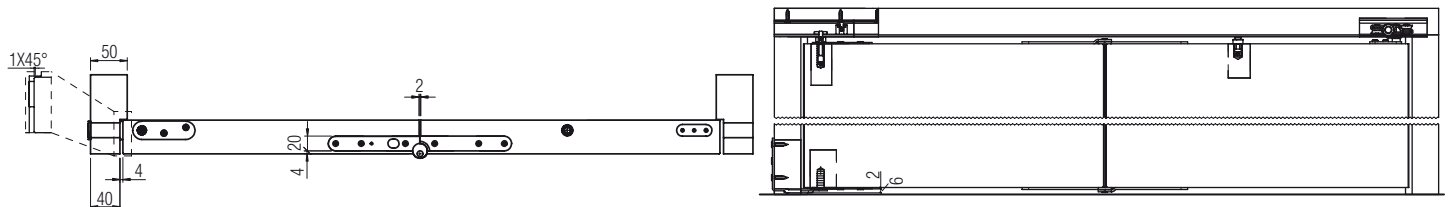

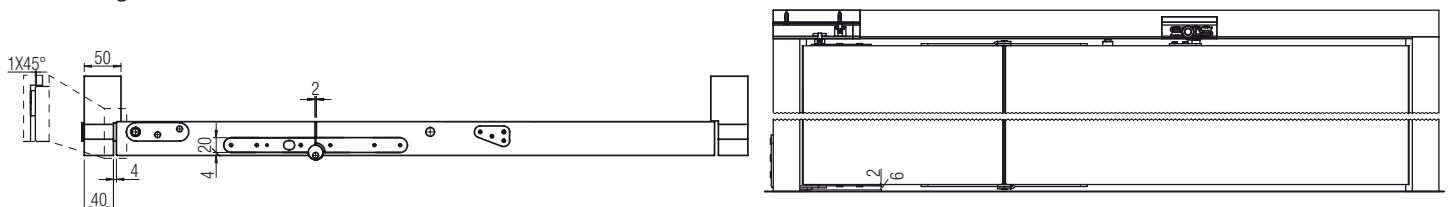

2/3 folding door

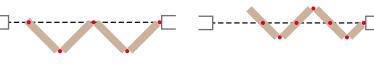
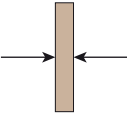
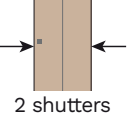
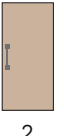
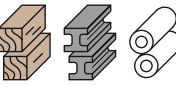

KIT 0200 4

Folding door kit. Flush-wall application and space occupied: all in one room or both rooms Installation with 2 equal or unequal shutters. Load capacity 50 kg.

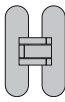
FOLDING Flush (Inside hinge) 	SPACE OCCUPIED All in one room Both rooms 	DOOR THICKNESS  minimum 35 mm	DOOR LEAF WIDTH  2 shutters maximum 1000 mm	NUMBER OF DOOR LEAF  2	DOOR MATERIAL Wood, Metal and PVC 
SYSTEM LOAD CAPACITY Up to 50 kg 	ROLLERS Roller: Nylon Wheels: POM 	OPTIONAL Concealed hinge 			

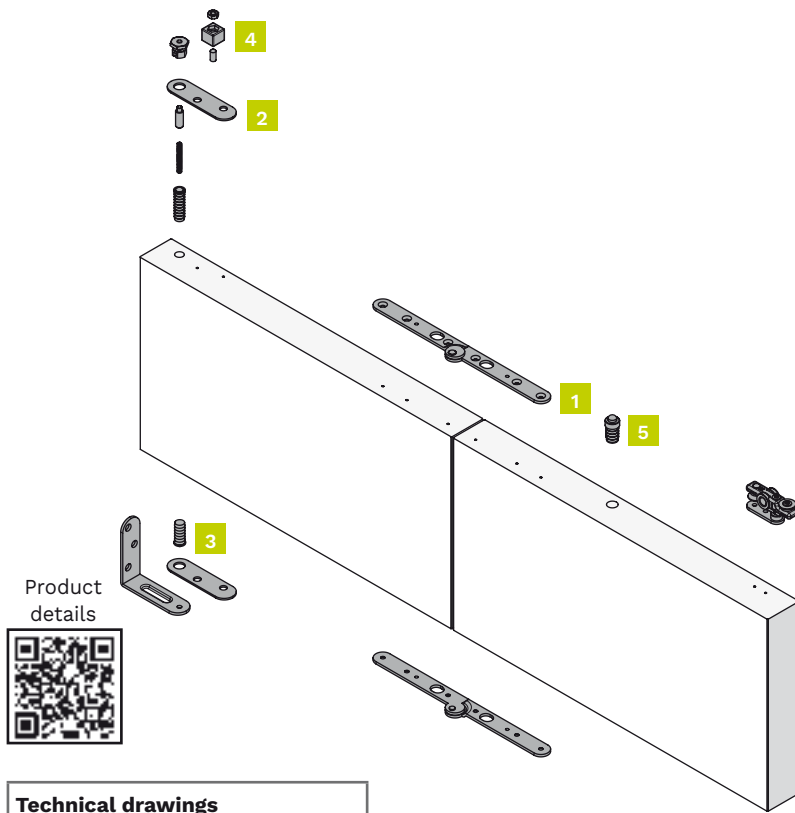

Kit components

2 doors set
Item number: 0200 4

Figure	Component	Quantity
1	Upper/Lower central bracket	2 pieces
2	Upper side hinge	1 piece
3	Lower side hinge	1 piece
4	End stop	1 piece
5	Stop brake	1 piece
6	Roller	1 piece

Complete the set in the section "Tracks, Accessories and Spare parts".

Technical drawings

Dimensions indicated in millimeters

Folding door

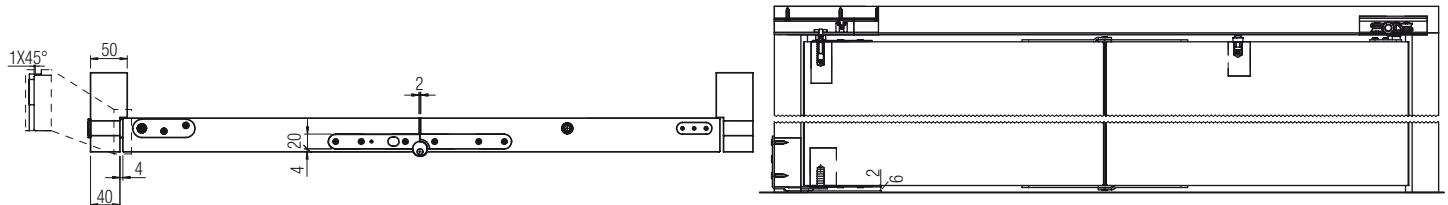

2/3 folding door

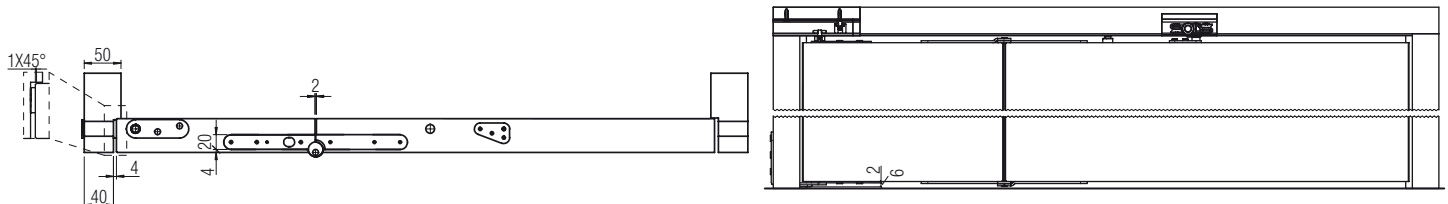

Tracks, Accessories and Spare parts 0200 1 / 0200 4

Complete the kit with track.

Installation examples	Dimensions tracks and accessories
<p>Dimensions indicated in millimeters</p>	





Tracks	
Black drilled and anodized track - 50 kg	Item number.
1 meter	0200 100
3 meters	0200 2
6 meters	0200 3

Spare parts			
Component	*Quantity	Item number.	Which set is it for?
Upper/Lower central bracket	2 pieces	0700 17	0200 1 / 0200 4
Upper side hinge	1 piece	0200 57	0200 1 / 0200 4
Lower side hinge	1 piece	0200 58	0200 1 / 0200 4
End stop	1 piece	0200 59	0200 1 / 0200 4
Stop brake	1 piece	0250 55	0200 1 / 0200 4
Roller	1 piece	0200 56	0200 1 / 0200 4
Pre-drilled and black anodised alu. track - 50 kg - 1 meter	1 piece	0200 100	0200 1
Pre-drilled and black anodised alu. track - 50 kg - 3 meters	1 piece	0200 2	0200 1
Pre-drilled and black anodised alu. track - 50 kg - 6 meters	1 piece	0200 3	0200 1

*The minimum order quantity is indicated.

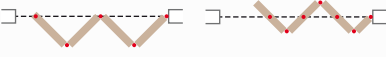
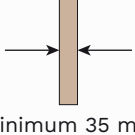
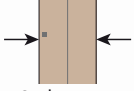
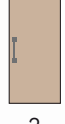
KIT 0200 1.1

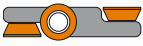
Folding door kit with a 1-meter track included. Flush-wall application and space occupied: all in one room or both rooms. Installation with 2 equal or unequal shutters. Load capacity 50 kg.

FOLDING Flush (Inside hinge) 	SPACE OCCUPIED All in one room Both rooms 	DOOR THICKNESS  minimum 35 mm	DOOR LEAF WIDTH  2 shutters maximum 1000 mm	NUMBER OF DOOR LEAF  2	DOOR MATERIAL Wood, Metal and PVC 
SYSTEM LOAD CAPACITY Up to 50 kg 	ROLLERS Roller: Nylon Wheels: POM 	INCLUDED IN THE KIT Black drilled and anodized track  1000 mm	OPTIONAL Concealed hinge 		

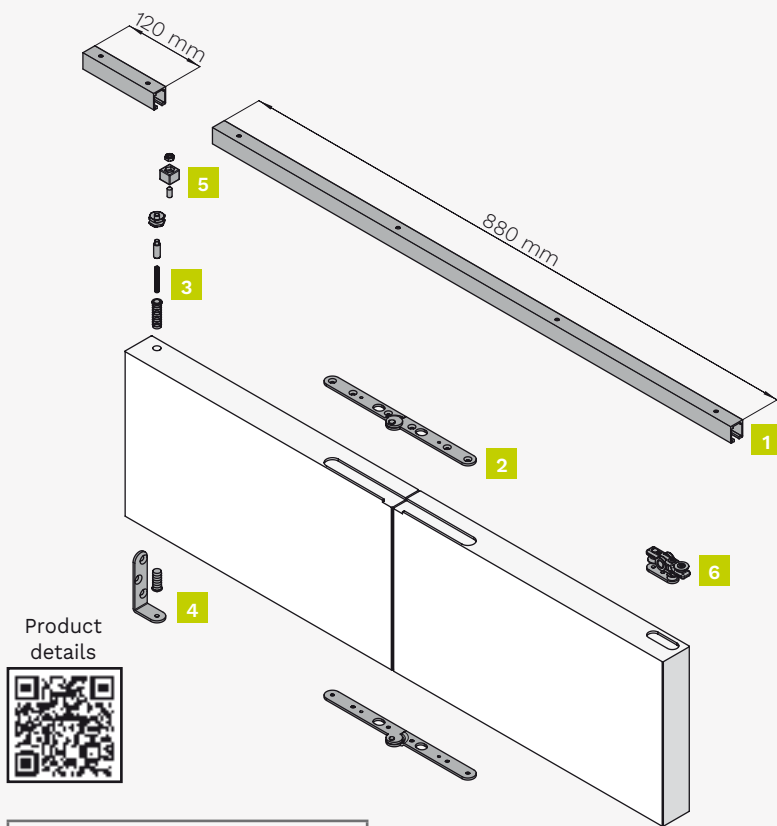

Kit components

2 doors set
Item number: 0200 1.1

Figure	Component	Quantity
1	Black drilled and anodized track - 1 meter	1 piece
2	Upper/Lower central bracket	2 pieces
3	Upper side hinge	1 piece
4	Lower side hinge	1 piece
5	End stop	1 piece
6	Roller	1 piece

Technical drawings

Dimensions indicated in millimeters

Folding door

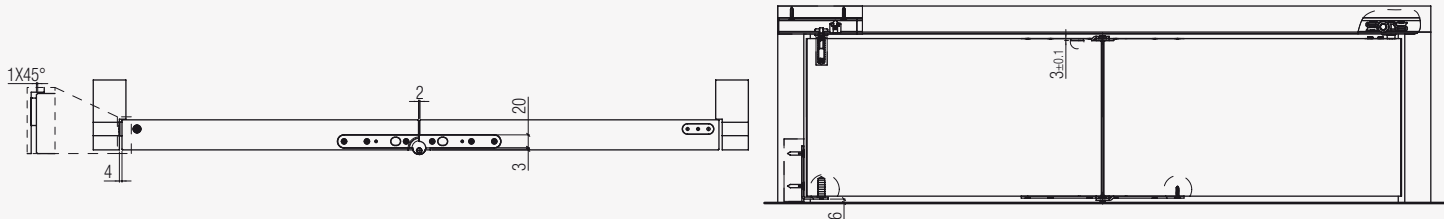

2/3 folding door

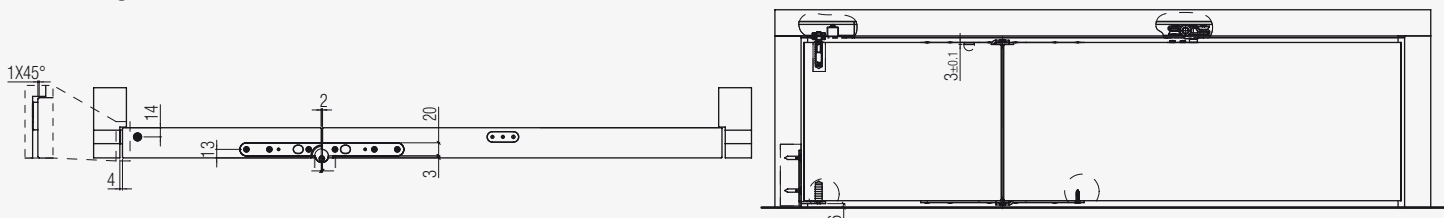

Tracks, Accessories and Spare parts 0200 1.1

Complete the kit with track.

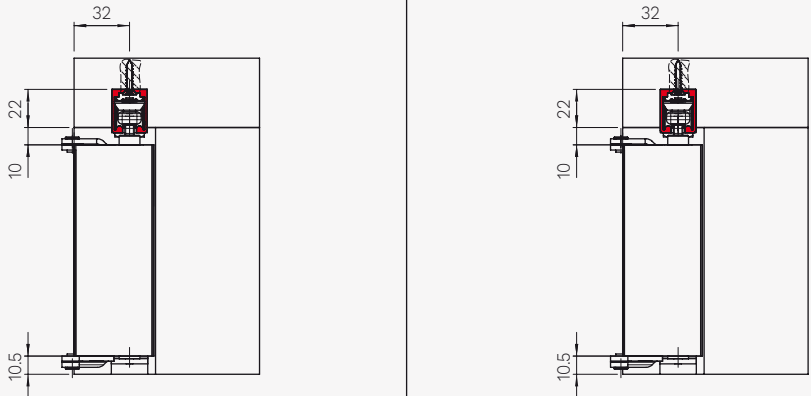
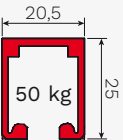
Installation examples	Dimensions tracks and accessories
<p>Dimensions indicated in millimeters</p> 	







Spare parts

Component	*Quantity	Item number.	Which set is it for?
Upper/Lower central bracket	2 pieces	0700 17	0200 1.1
End stop	1 piece	0200 59	0200 1.1
Roller	1 piece	0200 56	0200 1.1
Pre-drilled and black anodised alu. track - 50 kg - 1 meter	1 piece	0200 100	0200 1.1
Pre-drilled and black anodised alu. track - 50 kg - 3 meters	1 piece	0200 2	0200 1.1
Pre-drilled and black anodised alu. track - 50 kg - 6 meters	1 piece	0200 3	0200 1.1

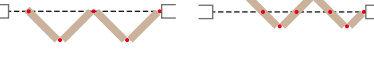
*The minimum order quantity is indicated.

KIT 0200 5

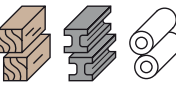
Folding door kit. Flush-wall application and space occupied: all in one room or both rooms. Installation with 2 equal or unequal shutters. Load capacity 50 kg.

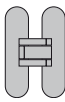
FOLDING Flush (Inside hinge) 	SPACE OCCUPIED All in one room Both rooms 	DOOR THICKNESS  minimum 35 mm	DOOR LEAF WIDTH  2 shutters maximum 1000 mm	NUMBER OF DOOR LEAF  2	DOOR MATERIAL Wood, Metal and PVC 
SYSTEM LOAD CAPACITY Up to 50 kg 	ROLLERS Roller: Nylon Wheels: POM 	OPTIONAL Concealed hinge 			

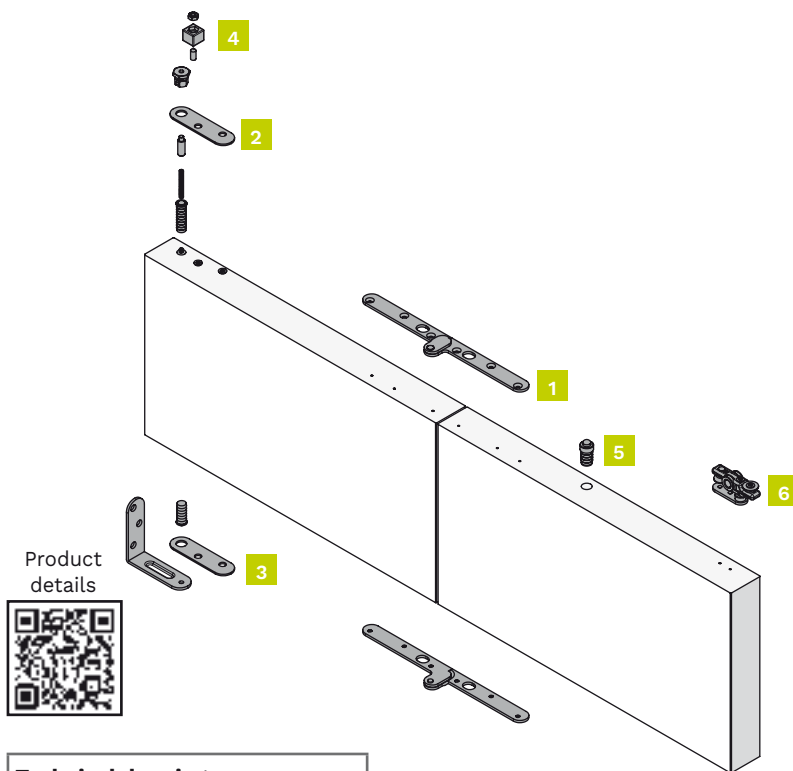

Kit components

2 doors set
Item number: 0200 5

Figure	Component	Quantity
1	Upper/Lower central bracket	2 pieces
2	Upper side hinge	1 piece
3	Lower side hinge	1 piece
4	End stop	1 piece
5	Stop brake	1 piece
6	Roller	1 piece

Complete the set in the section "Tracks, Accessories and Spare parts".

Technical drawings

Dimensions indicated in millimeters
 Folding door

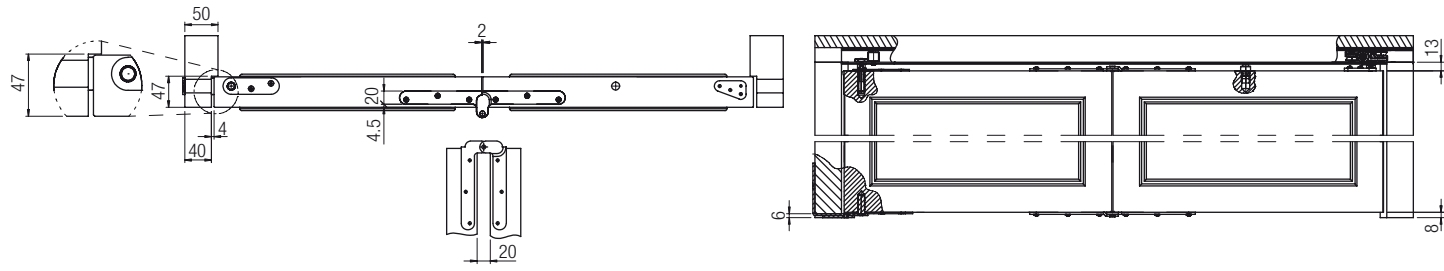

2/3 folding door

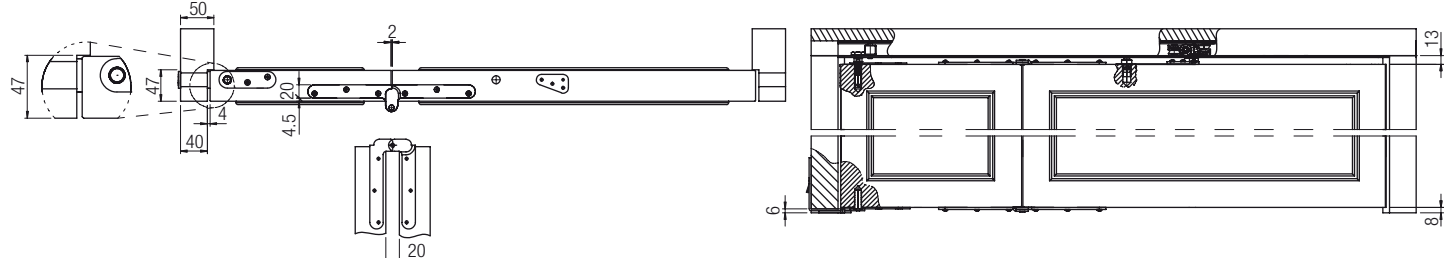

Tracks, Accessories and Spare parts 0200 5

Complete the kit with track.

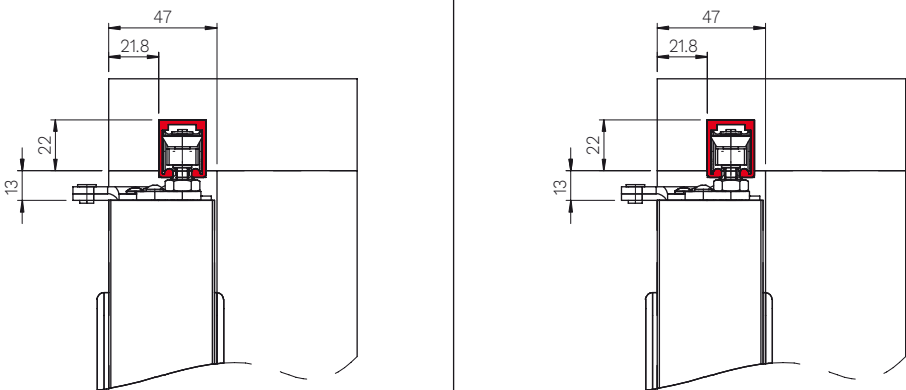
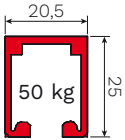





Installation examples	Dimensions tracks and accessories
<p>Dimensions indicated in millimeters</p> 	

Tracks	
Black drilled and anodized track - 50 kg	Item number.
1 meter	0200 100
3 meters	0200 2
6 meters	0200 3

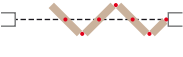
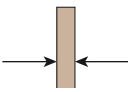
Spare parts			
Component	*Quantity	Item number.	Which set is it for?
Upper/Lower central bracket	2 pieces	0260 53 N DXSX	0200 5
Upper side hinge	1 piece	0200 57	0200 5
Lower side hinge	1 piece	0200 58	0200 5
End stop	1 piece	0200 59	0200 5
Stop brake	1 piece	0250 55	0200 5
Roller	1 piece	0200 56	0200 5

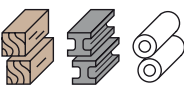
*The minimum order quantity is indicated.

SYSTEM 0700

<p>FOLDING Flush (Inside hinge)</p> 	<p>SPACE OCCUPIED Both rooms</p> 	<p>DOOR THICKNESS</p>  <p>minimum 25 mm maximum 40 mm</p>	<p>NUMBER OF DOOR LEAF</p>  <p>2-3-4-5-6-7-8</p>	<p>DOOR MATERIAL Wood, Metal and PVC</p> 	<p>SYSTEM LOAD CAPACITY Up to 120 kg</p> 
<p>ROLLERS 0700 4 Body: Zamak Wheels: 4, POM Ball bearings: 4 Bracket: Steel Capacity: 60 kg</p> 		<p>ROLLERS 0700 11 Body: Steel Wheels: 2, POM Ball bearings: 2 Bracket: Steel Capacity: 25 kg</p> 		<p>OPTIONAL Concealed hinge</p> 	



HOW TO CHOOSE 0700

0700 accordion folding system **can be set in various solutions** which vary according to the number of doors to be installed and their weight. The **maximum door leaf capacity table** is the first step in defining the solution that corresponds to your needs and ordering the necessary set.

What should I order?

It is necessary to know the **number of shutters** to install and the weight of each. Use the below table starting with the **number of shutters** and move in the same line towards right to identify the capacity equal or more than the weight of each shutter. When you have the capacity, you can get the solution indicated in red in the last column.

For example: to create a folding solution with 5 shutters where each weighs 20 kg, I will have to consult the page with solution 4 to define the items I have to order.

Table of maximum capacity per door leaf

N. of doors desired	Maximum capacity per door	Maximum capacity per door	Maximum capacity per door	Maximum capacity per door
2 doors	25 kg	40 kg	-	60 kg
3 doors	25 kg	26,6 kg	-	40 kg
4 doors	20 kg	-	25 kg	30 kg
5 doors	16 kg	-	-	24 kg
6 doors	-	13,3 kg	20 kg	-
7 doors	11,4 kg	-	17,1 kg	-
8 doors	10 kg	-	-	15 kg
	Solution 1 (page 174)	Solution 2 (page 175)	Solution 3 (page 176)	Solution 4 (page 177)

Product details



SOLUTION 1

The below table indicates the items to order and their quantities depending on the number of shutters to install.

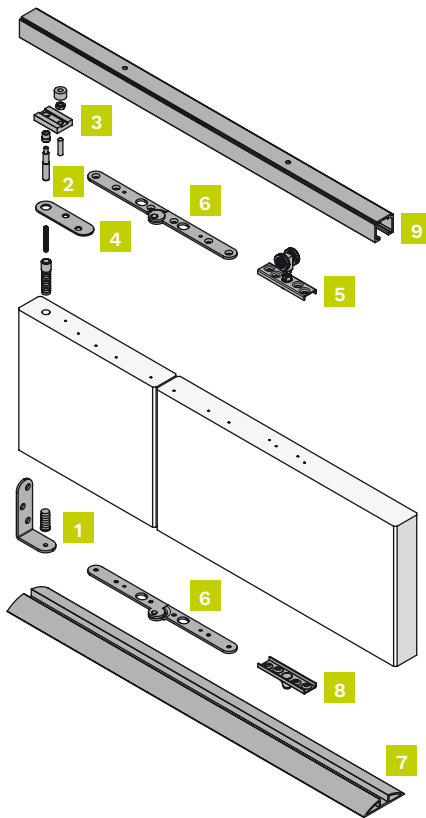

Doors	Starter kit (*)				Upper roller	Hinge	Floor guide	Lower runner	Track
	1	2	3	4	5	6	7	8	9
n° 2	1 x art. 0700 20				1 x art. 0700 11	2 x art. 0700 17 (**)	1 x art. (***)	1 x art. 0700 6	1 x art. (****)
n° 3	1 x art. 0700 20				2 x art. 0700 11	4 x art. 0700 17 (**)	1 x art. (***)	2 x art. 0700 6	1 x art. (****)
n° 4	1 x art. 0700 20				3 x art. 0700 11	6 x art. 0700 17 (**)	1 x art. (***)	3 x art. 0700 6	1 x art. (****)
n° 5	1 x art. 0700 20				4 x art. 0700 11	8 x art. 0700 17 (**)	1 x art. (***)	4 x art. 0700 6	1 x art. (****)
n° 6	1 x art. 0700 20				5 x art. 0700 11	10 x art. 0700 17 (**)	1 x art. (***)	5 x art. 0700 6	1 x art. (****)
n° 7	1 x art. 0700 20				6 x art. 0700 11	12 x art. 0700 17 (**)	1 x art. (***)	6 x art. 0700 6	1 x art. (****)
n° 8	1 x art. 0700 20				7 x art. 0700 11	14 x art. 0700 17 (**)	1 x art. (***)	7 x art. 0700 6	1 x art. (****)

(*)Set 0700 20 includes a bottom bracket, an upper pin, an upper pin anchor and 2 upper/lower supporting plates.

(**)Alternatively to the suggested model, it is possible to use concealed hinges by Krona Koblenz. The lower roller and runner positioning may vary based on which hinge has been applied. The correct installation and the number of hinges depend on the customer's choice.

Tracks and Floor guide

****Drilled and anodised aluminium track - 80 kg	Item number.
3 meters	0500 300
6 meters	0500 1
***Bottom guide in silver anodized aluminium	Item number.
3 meters	0700 14A
6 meters	0700 13A

Spare parts item number. 0700 20

Component	*Quantity	Item number.	Which set is it for?
Lower retainer bracket	1 piece	0700 15	0700 20
Upper retainer pin	1 piece	0700 16	0700 20
Upper pin clamp	1 piece	0700 19	0700 20
Upper/lower support plate	1 piece	0700 18	0700 20

*The minimum order quantity is indicated.

Technical drawings

Dimensions indicated in millimeters

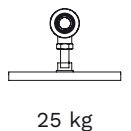
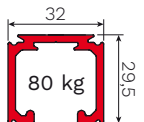
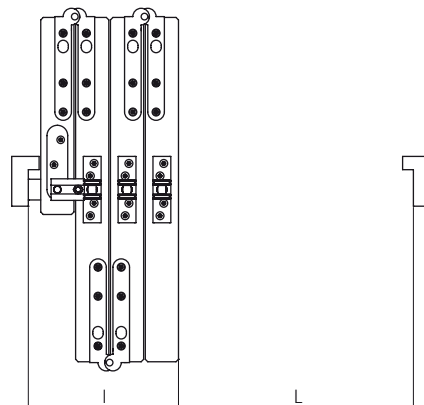
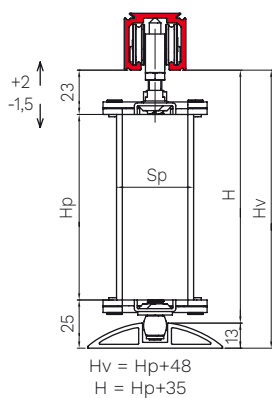

L = Effective clear width (mm) - H = Effective clear height (mm) - Hv = Wall opening height (under track / floor) (mm) - Hp = Door height (mm) - Sp = Door thickness (mm) - I = Open doors obstruction (mm) - N = Long doors number

SOLUTION 2

The below table indicates the items to order and their quantities depending on the number of shutters to install.

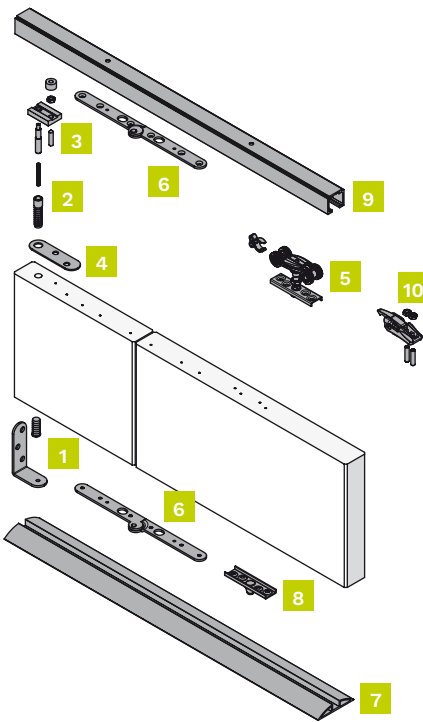

Doors	Starter kit (*)				Upper roller	Hinge	Floor guide	Lower runner	Track	Stop brake
	1	2	3	4	5	6	7	8	9	10
n° 2	1 x art. 0700 20				1 x art. 0700 4	2 x art. 0700 17 (**)	1 x art. (***)	1 x art. 0700 6	1 x art. (****)	1 x art. 0500 12
n° 3	1 x art. 0700 20				2 x art. 0700 4	4 x art. 0700 17 (**)	1 x art. (***)	2 x art. 0700 6	1 x art. (****)	1 x art. 0500 12
n° 4	1 x art. 0700 20				3 x art. 0700 4	6 x art. 0700 17 (**)	1 x art. (***)	3 x art. 0700 6	1 x art. (****)	1 x art. 0500 12
n° 5	1 x art. 0700 20				4 x art. 0700 4	8 x art. 0700 17 (**)	1 x art. (***)	4 x art. 0700 6	1 x art. (****)	1 x art. 0500 12
n° 6	1 x art. 0700 20				5 x art. 0700 4	10 x art. 0700 17 (**)	1 x art. (***)	5 x art. 0700 6	1 x art. (****)	1 x art. 0500 12
n° 7	1 x art. 0700 20				6 x art. 0700 4	12 x art. 0700 17 (**)	1 x art. (***)	6 x art. 0700 6	1 x art. (****)	1 x art. 0500 12
n° 8	1 x art. 0700 20				7 x art. 0700 4	14 x art. 0700 17 (**)	1 x art. (***)	7 x art. 0700 6	1 x art. (****)	1 x art. 0500 12

(*)Set 0700 20 includes a bottom bracket, an upper pin, an upper pin anchor and 2 upper/lower supporting plates.

(**)Alternatively to the suggested model, it is possible to use concealed hinges by Krona Koblenz. The lower roller and runner positioning may vary based on which hinge has been applied. The correct installation and the number of hinges depend on the customer's choice.

Tracks and Floor guide

****Drilled and anodised aluminium track - 80 kg	Item number.
3 meters	0500 300
6 meters	0500 1
***Bottom guide in silver anodized aluminium	Item number.
3 meters	0700 14A
6 meters	0700 13A

Spare parts item number. 0700 20

Component	*Quantity	Item number.	Which set is it for?
Lower retainer bracket	1 piece	0700 15	0700 20
Upper retainer pin	1 piece	0700 16	0700 20
Upper pin clamp	1 piece	0700 19	0700 20
Upper/lower support plate	1 piece	0700 18	0700 20

*The minimum order quantity is indicated.

Technical drawings

Dimensions indicated in millimeters

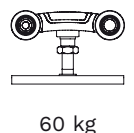
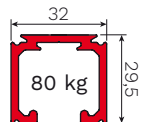
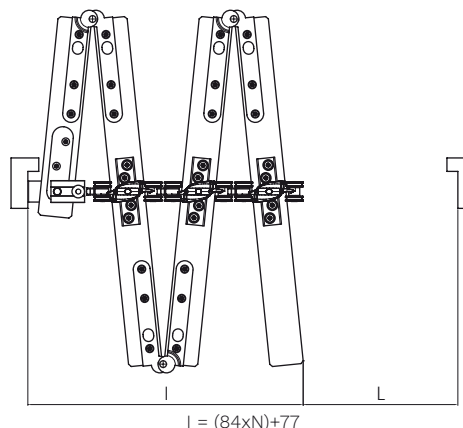
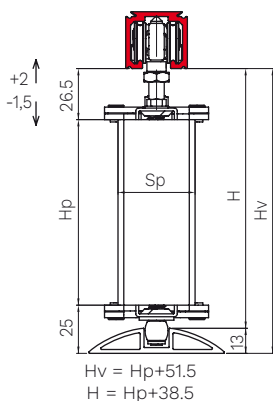

L = Effective clear width (mm) - H = Effective clear height (mm) - Hv = Wall opening height (under track / floor) (mm) - Hp = Door height (mm) - Sp = Door thickness (mm) - I = Open doors obstruction (mm) - N = Long doors number

SOLUTION 3

The below table indicates the items to order and their quantities depending on the number of shutters to install.

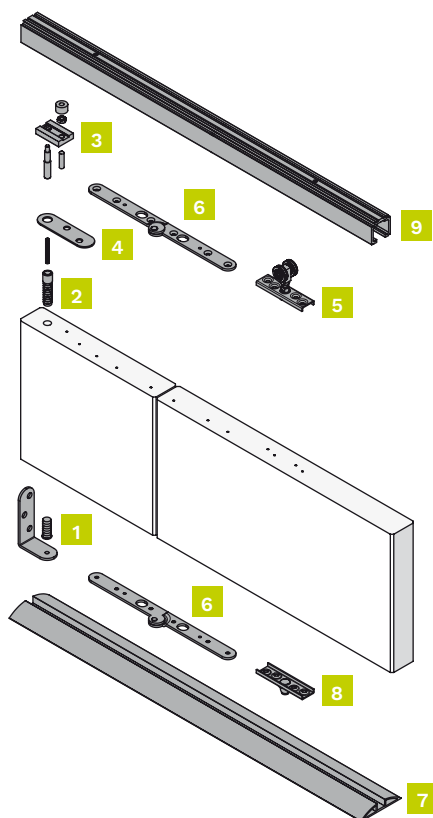

Doors	Starter kit (*)				Upper roller	Hinge	Floor guide	Lower runner	Track
	1	2	3	4	5	6	7	8	9
n° 2	1 x art. 0700 20				1 x art. 0700 11	2 x art. 0700 17 (**)	1 x art. (***)	1 x art. 0700 6	1 x art. (****)
n° 3	1 x art. 0700 20				2 x art. 0700 11	4 x art. 0700 17 (**)	1 x art. (***)	2 x art. 0700 6	1 x art. (****)
n° 4	1 x art. 0700 20				3 x art. 0700 11	6 x art. 0700 17 (**)	1 x art. (***)	3 x art. 0700 6	1 x art. (****)
n° 5	1 x art. 0700 20				4 x art. 0700 11	8 x art. 0700 17 (**)	1 x art. (***)	4 x art. 0700 6	1 x art. (****)
n° 6	1 x art. 0700 20				5 x art. 0700 11	10 x art. 0700 17 (**)	1 x art. (***)	5 x art. 0700 6	1 x art. (****)
n° 7	1 x art. 0700 20				6 x art. 0700 11	12 x art. 0700 17 (**)	1 x art. (***)	6 x art. 0700 6	1 x art. (****)
n° 8	1 x art. 0700 20				7 x art. 0700 11	14 x art. 0700 17 (**)	1 x art. (***)	7 x art. 0700 6	1 x art. (****)

(*)Set 0700 20 includes a bottom bracket, an upper pin, an upper pin anchor and 2 upper/lower supporting plates.

(**)Alternatively to the suggested model, it is possible to use concealed hinges by Krona Koblenz. The lower roller and runner positioning may vary based on which hinge has been applied. The correct installation and the number of hinges depend on the customer's choice.

Tracks and Floor guide

****Drilled and anodised aluminium track - 120 kg	Item number.
3 meters	0500 10 300
6 meters	0500 10
***Bottom guide in silver anodized aluminium	Item number.
3 meters	0700 14A
6 meters	0700 13A

Spare parts item number. 0700 20

Component	*Quantity	Item number.	Which set is it for?
Lower retainer bracket	1 piece	0700 15	0700 20
Upper retainer pin	1 piece	0700 16	0700 20
Upper pin clamp	1 piece	0700 19	0700 20
Upper/lower support plate	1 piece	0700 18	0700 20

*The minimum order quantity is indicated.

Technical drawings

Dimensions indicated in millimeters

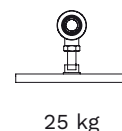
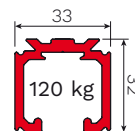
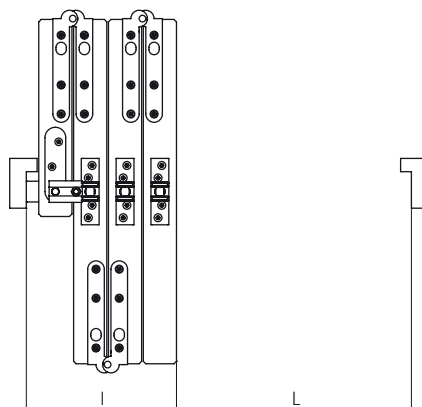
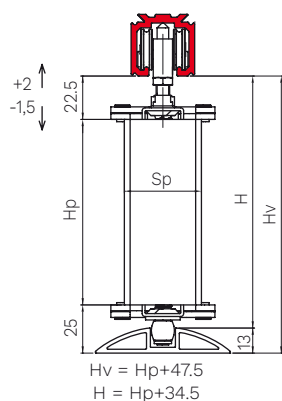

L = Effective clear width (mm) - H = Effective clear height (mm) - Hv = Wall opening height (under track / floor) (mm) - Hp = Door height (mm) - Sp = Door thickness (mm) - I = Open doors obstruction (mm) - N = Long doors number

SOLUTION 4

The below table indicates the items to order and their quantities depending on the number of shutters to install.

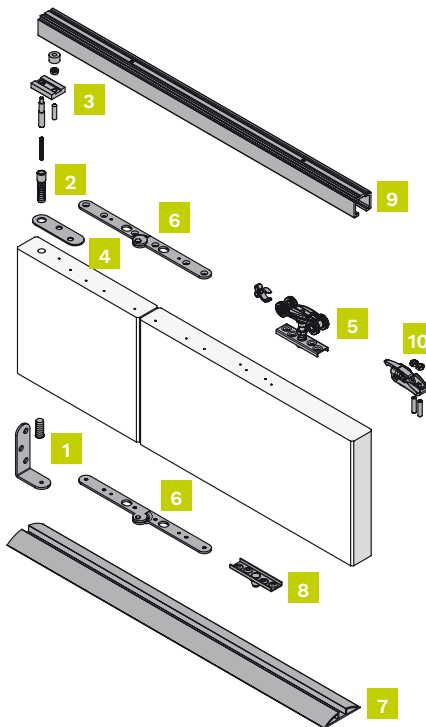

Doors	Starter kit (*)				Upper roller	Hinge	Floor guide	Lower runner	Track	Stop brake
	1	2	3	4	5	6	7	8	9	10
n° 2	1 x art. 0700 20				1 x art. 0700 4	2 x art. 0700 17 (**)	1 x art. (***)	1 x art. 0700 6	1 x art. (***)	1 x art. 0500 12
n° 3	1 x art. 0700 20				2 x art. 0700 4	4 x art. 0700 17 (**)	1 x art. (***)	2 x art. 0700 6	1 x art. (***)	1 x art. 0500 12
n° 4	1 x art. 0700 20				3 x art. 0700 4	6 x art. 0700 17 (**)	1 x art. (***)	3 x art. 0700 6	1 x art. (***)	1 x art. 0500 12
n° 5	1 x art. 0700 20				4 x art. 0700 4	8 x art. 0700 17 (**)	1 x art. (***)	4 x art. 0700 6	1 x art. (***)	1 x art. 0500 12
n° 6	1 x art. 0700 20				5 x art. 0700 4	10 x art. 0700 17 (**)	1 x art. (***)	5 x art. 0700 6	1 x art. (***)	1 x art. 0500 12
n° 7	1 x art. 0700 20				6 x art. 0700 4	12 x art. 0700 17 (**)	1 x art. (***)	6 x art. 0700 6	1 x art. (***)	1 x art. 0500 12
n° 8	1 x art. 0700 20				7 x art. 0700 4	14 x art. 0700 17 (**)	1 x art. (***)	7 x art. 0700 6	1 x art. (***)	1 x art. 0500 12

(*)Set 0700 20 includes a bottom bracket, an upper pin, an upper pin anchor and 2 upper/lower supporting plates.

(**)Alternatively to the suggested model, it is possible to use concealed hinges by Krona Koblenz. The lower roller and runner positioning may vary based on which hinge has been applied. The correct installation and the number of hinges depend on the customer's choice.

Tracks and Floor guide

****Drilled and anodised aluminium track - 120 kg	Item number.
3 meters	0500 10 300
6 meters	0500 10
***Bottom guide in silver anodized aluminium	Item number.
3 meters	0700 14A
6 meters	0700 13A

Spare parts item number. 0700 20

Component	*Quantity	Item number.	Which set is it for?
Lower retainer bracket	1 piece	0700 15	0700 20
Upper retainer pin	1 piece	0700 16	0700 20
Upper pin clamp	1 piece	0700 19	0700 20
Upper/lower support plate	1 piece	0700 18	0700 20

*The minimum order quantity is indicated.

Technical drawings



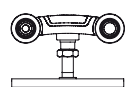
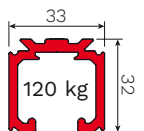
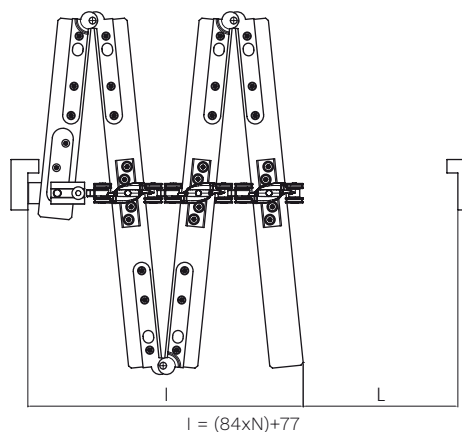
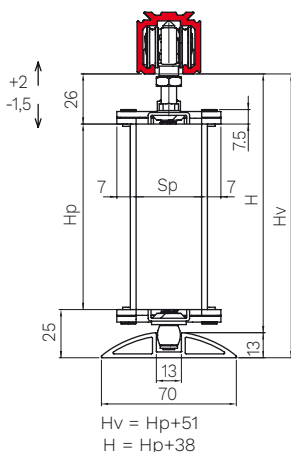



Dimensions indicated in millimeters

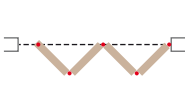
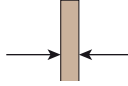
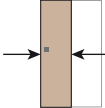

60 kg

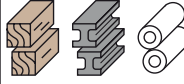
L = Effective clear width (mm) - H = Effective clear height (mm) - Hv = Wall opening height (under track / floor) (mm) - Hp = Door height (mm) - Sp = Door thickness (mm) - I = Open doors obstruction (mm) - N = Long doors number

SYSTEM 0710

<p>FOLDING Flush (Inside hinge)</p> 	<p>SPACE OCCUPIED All in one room</p> 	<p>DOOR THICKNESS</p>  <p>minimum 25 mm maximum 40 mm</p>	<p>DOOR LEAF WIDTH</p>  <p>maximum 600 mm</p>	<p>NUMBER OF DOOR LEAF</p>  <p>2-4-6-8</p>	<p>DOOR MATERIAL Wood, Metal and PVC</p> 	<p>SYSTEM LOAD CAPACITY Up to 120 kg</p> 
<p>ROLLERS 0700 4 Body: Zamak Wheels: 4, POM Ball bearings: 4 Bracket: Steel Capacity: 60 kg</p> 		<p>ROLLERS 0700 11 Body: Steel Wheels: 2, POM Ball bearings: 2 Bracket: Steel Capacity: 25 kg</p> 		<p>OPTIONAL Concealed hinge</p> 		



HOW TO CHOOSE 0710

0710 accordion folding system **can be set in various solutions** which vary according to the number of doors to be installed and their weight. The **maximum door leaf capacity table** is the first step in defining the solution that corresponds to your needs and ordering the necessary set.

What should I order?

It is necessary to know the **number of shutters** to install and the weight of each.

Use the below table starting with the **number of shutters** and move in the same line towards right to identify the capacity equal or more than the weight of each shutter. When you have the capacity, you can get the solution indicated in red in the last column.

For example: to create a folding solution with 6 shutters where each weighs 13 kg, I will have to consult the page with solution 2 to define the items I have to order.

Table of maximum capacity per door leaf

N. of doors desired	Maximum capacity per door	Maximum capacity per door	Maximum capacity per door	Maximum capacity per door
2 doors	12,5 kg	30 kg	-	-
4 doors	12,5 kg	20 kg	-	30 kg
6 doors	12,5 kg	13,3 kg	-	20 kg
8 doors	10 kg	-	12,5 kg	15 kg
	Solution 1 (page 180)	Solution 2 (page 181)	Solution 3 (page 182)	Solution 4 (page 183)

Product details

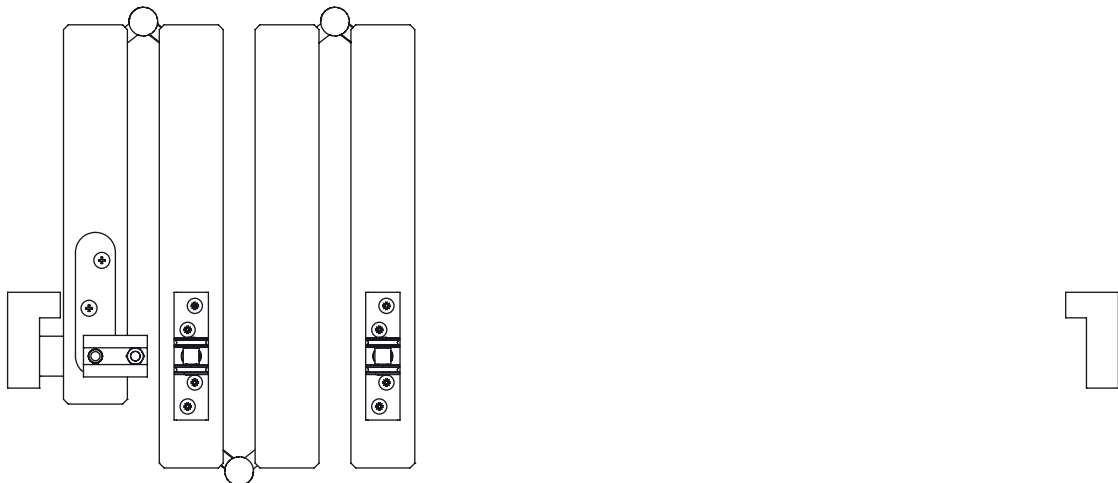

SOLUTION 1

The below table indicates the items to order and their quantities depending on the number of shutters to install.

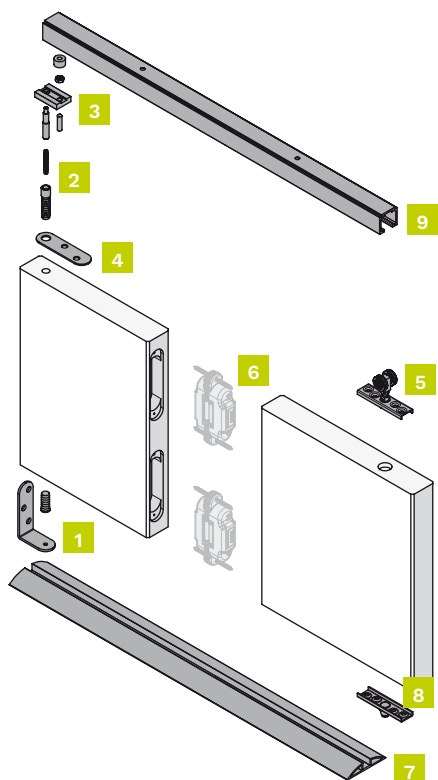

Doors	Starter kit (*)				Upper roller	Hinge	Floor guide	Lower runner	Track
	1	2	3	4	5	6	7	8	9
n° 2	1 x	art. 0700 20	1 x	art. 0700 11	min. 2 x (**)	1 x	art. (***)	1 x	art. (****)
n° 4	1 x	art. 0700 20	2 x	art. 0700 11	min. 6 x (**)	1 x	art. (***)	2 x	art. (****)
n° 6	1 x	art. 0700 20	3 x	art. 0700 11	min. 10 x (**)	1 x	art. (***)	3 x	art. (****)
n° 8	1 x	art. 0700 20	4 x	art. 0700 11	min. 14 x (**)	1 x	art. (***)	4 x	art. (****)

(*)Set 0700 20 includes a bottom bracket, an upper pin, an upper pin anchor and 2 upper/lower supporting plates.

(**)It is possible to use concealed hinges by Krona Koblenz or single axis hinges. The lower roller and runner positioning may vary based on which hinge has been applied. The correct installation and the number of hinges depend on the customer's choice.

Tracks and Floor guide

****Drilled and anodised aluminium track - 80 kg	Item number.
3 meters	0500 300
6 meters	0500 1
****Bottom guide in silver anodized aluminium	Item number.
3 meters	0700 14A
6 meters	0700 13A

Spare parts item number. 0700 20

Component	*Quantity	Item number.	Which set is it for?
Lower retainer bracket	1 piece	0700 15	0700 20
Upper retainer pin	1 piece	0700 16	0700 20
Upper pin clamp	1 piece	0700 19	0700 20
Upper/lower support plate	1 piece	0700 18	0700 20

*The minimum order quantity is indicated.

Technical drawings

Dimensions indicated in millimeters

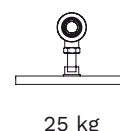
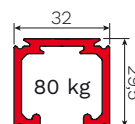
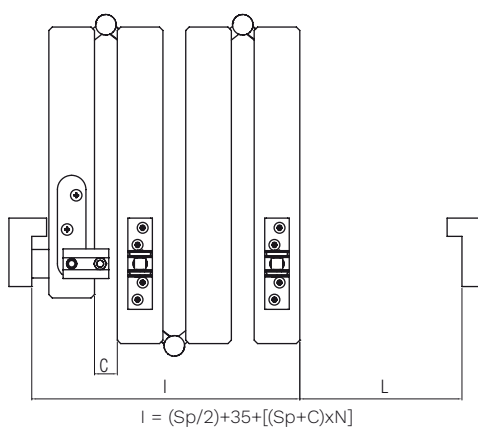
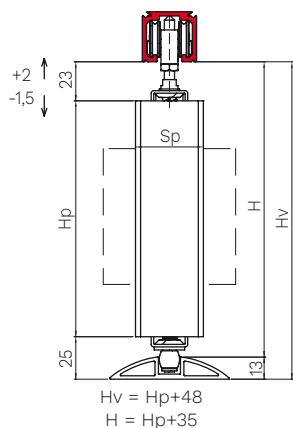

L = Effective clear width (mm) - H = Effective clear height (mm) - Hv = Wall opening height (under track / floor) (mm) - Hp = Door height (mm) - Sp = Door thickness (mm) - I = Open doors obstruction (mm) - N = Long doors number - C = Passage between open doors (depending on the hinge type) (mm)

SOLUTION 2

The below table indicates the items to order and their quantities depending on the number of shutters to install.

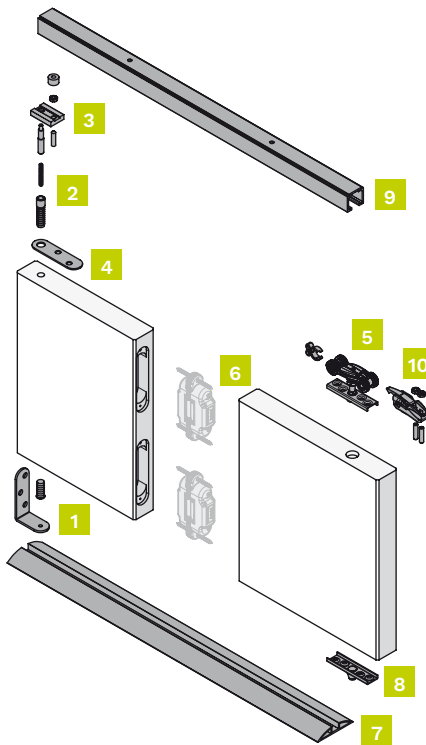

Doors	Starter kit (*)	Upper roller	Hinge	Floor guide	Lower runner	Track	Stop brake
	1 2 3 4	5	6	7	8	9	10
n° 2	1 x art. 0700 20	1 x art. 0700 4	min. 2 x (**)	1 x art. (***)	1 x art. 0700 6	1 x art. (****)	1 x art. 0500 12
n° 4	1 x art. 0700 20	2 x art. 0700 4	min. 6 x (**)	1 x art. (***)	2 x art. 0700 6	1 x art. (****)	1 x art. 0500 12
n° 6	1 x art. 0700 20	3 x art. 0700 4	min. 10 x (**)	1 x art. (***)	3 x art. 0700 6	1 x art. (****)	1 x art. 0500 12
n° 8	1 x art. 0700 20	4 x art. 0700 4	min. 14 x (**)	1 x art. (***)	4 x art. 0700 6	1 x art. (****)	1 x art. 0500 12

(*)Set 0700 20 includes a bottom bracket, an upper pin, an upper pin anchor and 2 upper/lower supporting plates.

(**)It is possible to use concealed hinges by Krona Koblenz or single axis hinges. The lower roller and runner positioning may vary based on which hinge has been applied. The correct installation and the number of hinges depend on the customer's choice.

Tracks and Floor guide

****Drilled and anodised aluminium track - 80 kg	Item number.
3 meters	0500 300
6 meters	0500 1
***Bottom guide in silver anodised aluminium	Item number.
3 meters	0700 14A
6 meters	0700 13A

Spare parts item number. 0700 20

Component	*Quantity	Item number.	Which set is it for?
Lower retainer bracket	1 piece	0700 15	0700 20
Upper retainer pin	1 piece	0700 16	0700 20
Upper pin clamp	1 piece	0700 19	0700 20
Upper/lower support plate	1 piece	0700 18	0700 20

*The minimum order quantity is indicated.

Technical drawings

Dimensions indicated in millimeters

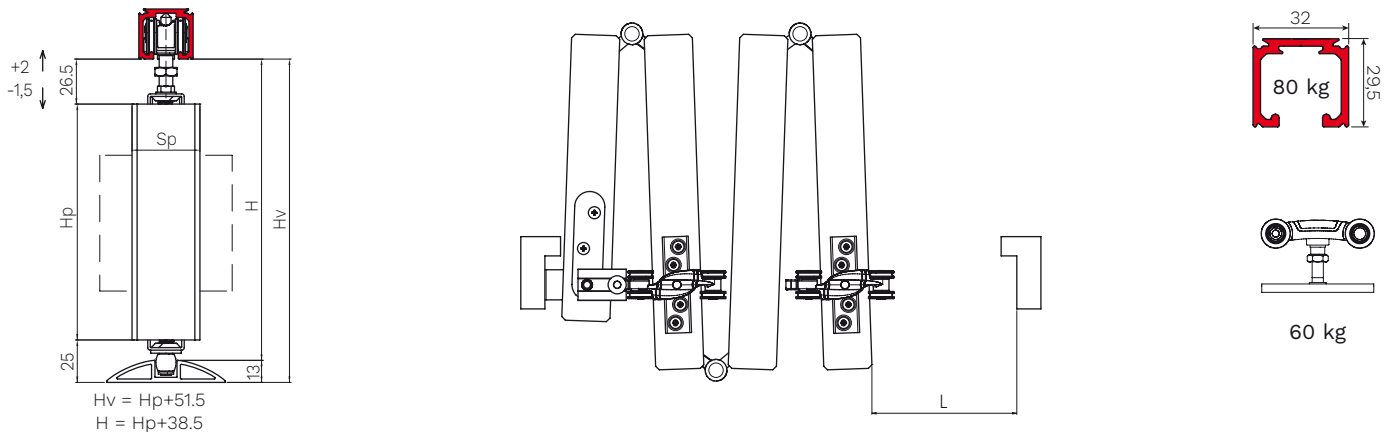

L = Effective clear width (mm) - H = Effective clear height (mm) - Hv = Wall opening height (under track / floor) (mm) - Hp = Door height (mm) - Sp = Door thickness (mm) - I = Open doors obstruction (mm) - N = Long doors number - C = Passage between open doors (depending on the hinge type) (mm)

SOLUTION 3

The below table indicates the items to order and their quantities depending on the number of shutters to install.

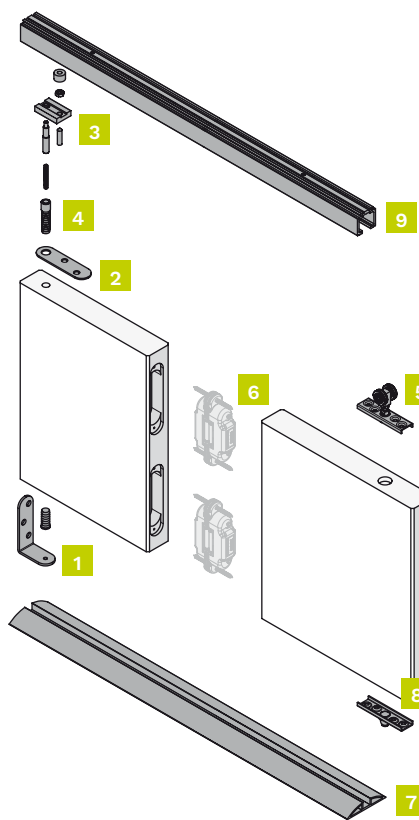

Doors	Starter kit (*)	Upper roller	Hinge	Floor guide	Lower runner	Track
	1 2 3 4	5	6	7	8	9
n° 2	1 x art. 0700 20	1 x art. 0700 11	min. 2 x (**)	1 x art. (***)	1 x art. 0700 6	1 x art. (****)
n° 4	1 x art. 0700 20	2 x art. 0700 11	min. 6 x (**)	1 x art. (***)	2 x art. 0700 6	1 x art. (****)
n° 6	1 x art. 0700 20	3 x art. 0700 11	min. 10 x (**)	1 x art. (***)	3 x art. 0700 6	1 x art. (****)
n° 8	1 x art. 0700 20	4 x art. 0700 11	min. 14 x (**)	1 x art. (***)	4 x art. 0700 6	1 x art. (****)

(*)Set 0700 20 includes a bottom bracket, an upper pin, an upper pin anchor and 2 upper/lower supporting plates.

(**)It is possible to use concealed hinges by Krona Koblenz or single axis hinges. The lower roller and runner positioning may vary based on which hinge has been applied. The correct installation and the number of hinges depend on the customer's choice.

Tracks and Floor guide

****Drilled and anodised aluminium track - 120 kg	Item number.
3 meters	0500 10 300
6 meters	0500 10
****Bottom guide in silver anodized aluminium	Item number.
3 meters	0700 14A
6 meters	0700 13A

Spare parts item number. 0700 20

Component	*Quantity	Item number.	Which set is it for?
Lower retainer bracket	1 piece	0700 15	0700 20
Upper retainer pin	1 piece	0700 16	0700 20
Upper pin clamp	1 piece	0700 19	0700 20
Upper/lower support plate	1 piece	0700 18	0700 20

*The minimum order quantity is indicated.

Technical drawings

Dimensions indicated in millimeters

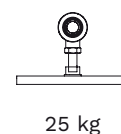
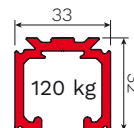
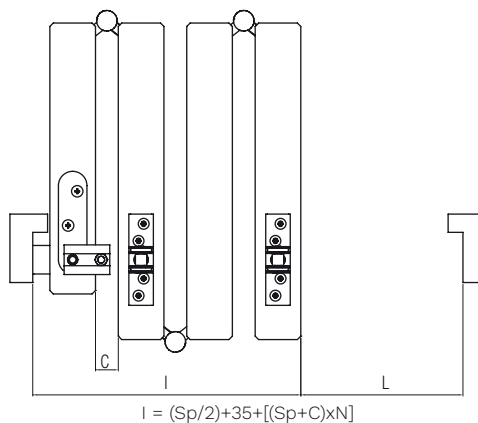
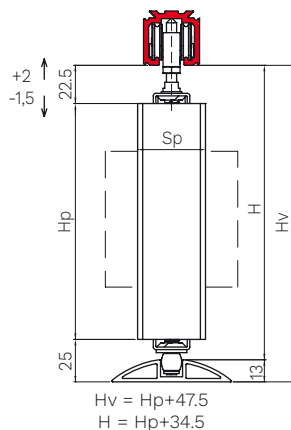

L = Effective clear width (mm) - H = Effective clear height (mm) - Hv = Wall opening height (under track / floor) (mm) - Hp = Door height (mm) - Sp = Door thickness (mm) - I = Open doors obstruction (mm) - N = Long doors number - C = Passage between open doors (depending on the hinge type) (mm)

SOLUTION 4

The below table indicates the items to order and their quantities depending on the number of shutters to install.

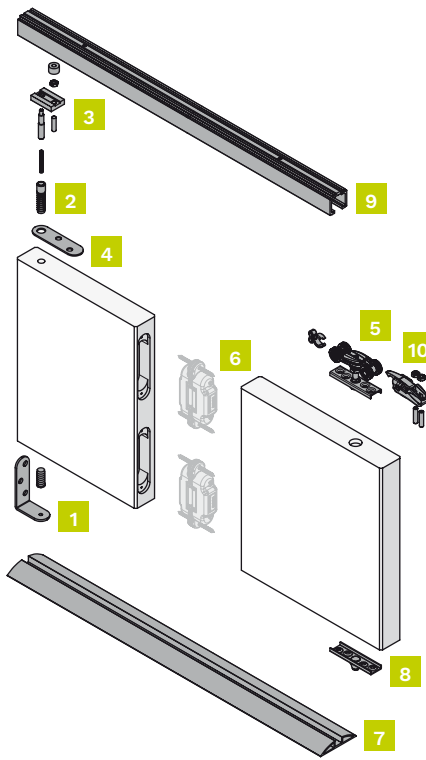

Doors	Starter kit (*)	Upper roller	Hinge	Floor guide	Lower runner	Track	Stop brake
	1 2 3 4	5	6	7	8	9	10
n° 2	1 x art. 0700 20	1 x art. 0700 4	min. 2 x (**)	1 x art. (***)	1 x art. 0700 6	1 x art. (****)	1 x art. 0500 12
n° 4	1 x art. 0700 20	2 x art. 0700 4	min. 6 x (**)	1 x art. (***)	2 x art. 0700 6	1 x art. (****)	1 x art. 0500 12
n° 6	1 x art. 0700 20	3 x art. 0700 4	min. 10 x (**)	1 x art. (***)	3 x art. 0700 6	1 x art. (****)	1 x art. 0500 12
n° 8	1 x art. 0700 20	4 x art. 0700 4	min. 14 x (**)	1 x art. (***)	4 x art. 0700 6	1 x art. (****)	1 x art. 0500 12

(*)Set 0700 20 includes a bottom bracket, an upper pin, an upper pin anchor and 2 upper/lower supporting plates.

(**)It is possible to use concealed hinges by Krona Koblenz or single axis hinges. The lower roller and runner positioning may vary based on which hinge has been applied. The correct installation and the number of hinges depend on the customer's choice.

Tracks and Floor guide

****Drilled and anodised aluminium track - 120 kg	Item number.
3 meters	0500 10 300
6 meters	0500 10
***Bottom guide in silver anodized aluminium	Item number.
3 meters	0700 14A
6 meters	0700 13A

Spare parts item number. 0700 20

Component	*Quantity	Item number.	Which set is it for?
Lower retainer bracket	1 piece	0700 15	0700 20
Upper retainer pin	1 piece	0700 16	0700 20
Upper pin clamp	1 piece	0700 19	0700 20
Upper/lower support plate	1 piece	0700 18	0700 20

*The minimum order quantity is indicated.

Technical drawings

Dimensions indicated in millimeters

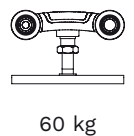
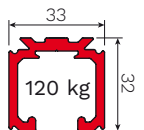
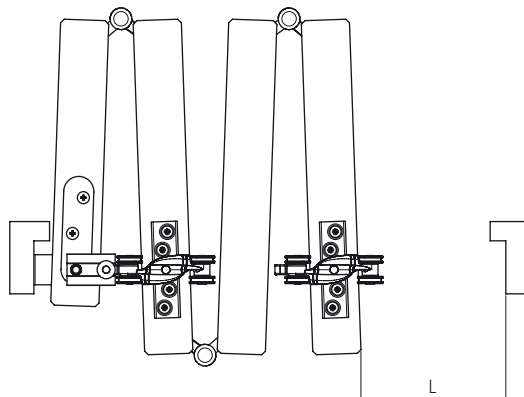
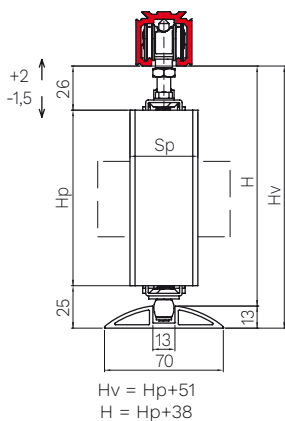





L = Effective clear width (mm) - H = Effective clear height (mm) - Hv = Wall opening height (under track / floor) (mm) - Hp = Door height (mm) - Sp = Door thickness (mm) - I = Open doors obstruction (mm) - N = Long doors number - C = Passage between open doors (depending on the hinge type) (mm)

SWINGING-SLIDING DOORS SYSTEMS

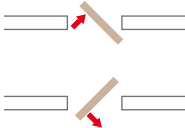
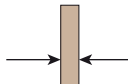
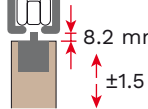
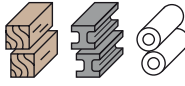

SwingLife

<p>APPLICATION Swinging</p> 	<p>OPENING Push / Pull</p> 	<p>DOOR THICKNESS</p>  <p>minimum 35 mm maximum 50 mm</p>	<p>FIXING Bracket embedded in the door</p> 	<p>DOOR MATERIAL Wood, Metal and PVC</p> 	<p>SYSTEM LOAD CAPACITY Up to 70 kg</p> 	<p>ROLLERS Roller: Nylon Wheels: POM Ball bearings: 4</p> 
<p>SOFT-CLOSE</p> <p>ABS ●●●●●●●●</p> <p>SINGLE</p> <p>Type: Mechanic Covering: Plastic</p>		<p>FIXING SCREWS Included</p> 				

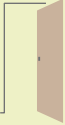
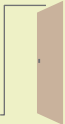
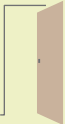
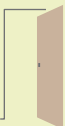

System	Load capacity	Door thickness	Application	Soft-close	Door leaf width	Page
[Technical Guides] How to interpret and correlate widths and heights SwingLife Universal						188
SwingLife Universal ABS	70 kg	minimum 35 mm maximum 50 mm	Swinging 	Yes	minimum 715 mm maximum 965 mm	190
Kit SwingLife Universal ABS						191
SwingLife Universal	70 kg	minimum 35 mm maximum 50 mm	Swinging 	No	minimum 715 mm maximum 965 mm	192
Kit SwingLife Universal						193
[Technical Guides] How to interpret and correlate widths and heights SwingLife Standard						194
SwingLife Standard ABS	70 kg	minimum 35 mm maximum 50 mm	Swinging 	Yes	minimum 665 mm maximum 915 mm	196
Kit SwingLife Standard ABS						197
SwingLife Standard	70 kg	minimum 35 mm maximum 50 mm	Swinging 	No	minimum 565 mm maximum 915 mm	198
Kit SwingLife Standard						199
Accessories and Spare parts SwingLife						200

TERMS AND DEFINITIONS

• OPENING BY PUSH AND PULL

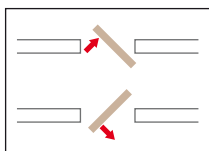

The opening can be carried out in both directions, both by pushing on the door handle and pulling it.

• BRACKET EMBEDDED IN THE DOOR

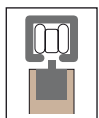

A door embedded bracket allows to have a reduced upper gap.

• DOOR LEAF WIDTH

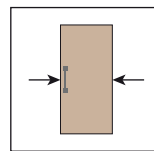

The indicated types of width are available in stock. For other sizes get in touch with Krona Koblenz.

• UNIVERSAL

It means that the width can be tailor-made within a specific range. It allows to have an easier suitability for any standard door width.

[TECHNICAL GUIDES] HOW TO INTERPRET AND CORRELATE WIDTHS AND HEIGHTS SWINGLIFE UNIVERSAL

HOW TO IDENTIFY THE WIDTH

In the SwingLife Universal version the door leaf width can be **cut to size** in the range of 715 mm - 965 mm. The table below shows how the given clear opening width and the wall opening width change in the possible door leaf sizes.

How do you read the table?

The table is bidirectional. Based on your starting point (door leaf width, given clear opening width or wall opening width), you can find out the dimensions of the other widths.

Example: If I have a wall opening with the width of 900 mm, the door leaf must be 765 mm and its clear opening will be 723 mm with a 50 mm thick door leaf.

Panel width (Lp)	Given clear opening width (Lup)	Wall opening width (Lvm)
715 mm	673 mm*	850 mm
715 mm < Lp < 965 mm	$Lp - 17 - Sp/2$	$Lp + 135$ mm
965 mm	923 mm*	1100 mm

*Calculated with door leaf thickness of 50 mm. With smaller thicknesses, the given clear opening width is larger.

How to calculate the given clear opening width (Lup)?

The given clear opening width is calculated according to the following formula: $Lp - 17 - Sp/2$

How to calculate the wall opening width (Lvm)?

The wall opening width is calculated according to the following formula: $Lp + 135$ mm

HOW TO IDENTIFY THE HEIGHT

In the SwingLife Universal version the available door leaf heights are 2034 mm, 2084 mm and 2384 mm. In the below table it is indicated how the clear opening height and the wall opening height change depending on the height options.

How do you read the table?

The table is bidirectional. Based on your starting point (door leaf height, given clear opening height or wall opening height), you can find out the dimensions of the other heights.

Example: If your wall opening is 2150 mm high, the door leaf must be 2084 mm high and the clear opening will be 2101 mm.

Panel height (Hp)	Given clear opening height (Hup)	Wall opening height (Hvm)
2034 mm	2051 mm	2100 mm
2084 mm	2101 mm	2150 mm
2384 mm	2401 mm	2350 mm

How to calculate the given clear opening height (Hup)?

The given clear opening height is calculated according to the following formula: $Hp + 17$ mm

How to calculate the wall opening height (Hvm)?

The wall opening height is calculated according to the following formula: $Hp + 66$ mm

HOW TO INTERPRET WIDTHS AND HEIGHTS

Widths

[Lp] Panel width

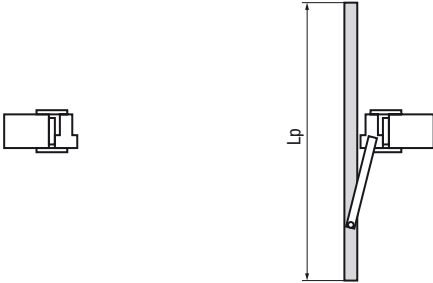

[Lup] Given clear opening width

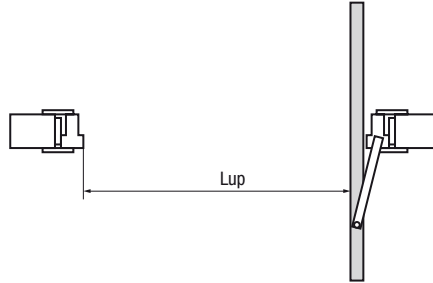

[Lvm] Wall opening width

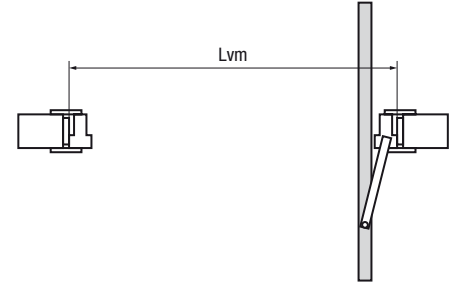

Heights

[Hp] Panel height

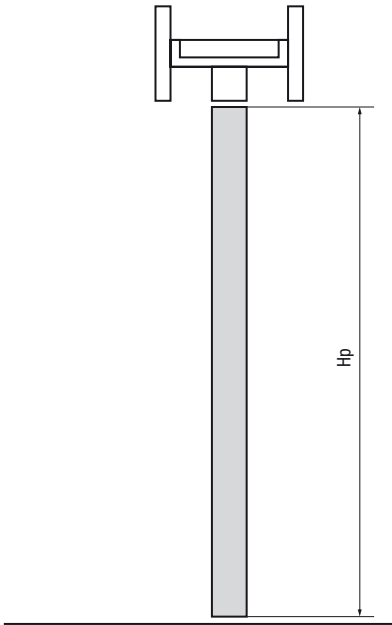

[Hup] Given clear opening height

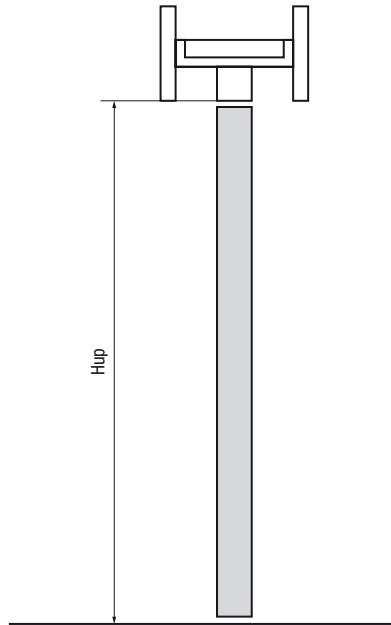







[Hvm] Wall opening height

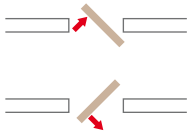
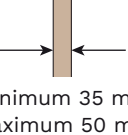

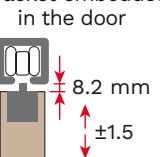
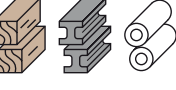
SWINGLIFE UNIVERSAL ABS

Pivot sliding door system. Push and pull opening. Fast installation. Single ABS. Nylon roller. Door leaf width range: 715/965 mm. Load capacity 70 kg.

APPLICATION Swinging 	OPENING Push / Pull 	DOOR THICKNESS  minimum 35 mm maximum 50 mm	DOOR LEAF WIDTH  minimum 715 mm maximum 965 mm	TRACK  It can be cut to size based on the door width	FIXING Bracket embedded in the door  8.2 mm ±1.5	DOOR MATERIAL Wood, Metal and PVC 
SYSTEM LOAD CAPACITY Up to 70 kg 	ROLLERS Roller: Nylon Wheels: POM Ball bearings: 4 	SOFT-CLOSE ABS ●●●●●●●● SINGLE Type: Mechanic Covering: Plastic	FIXING SCREWS Included 			

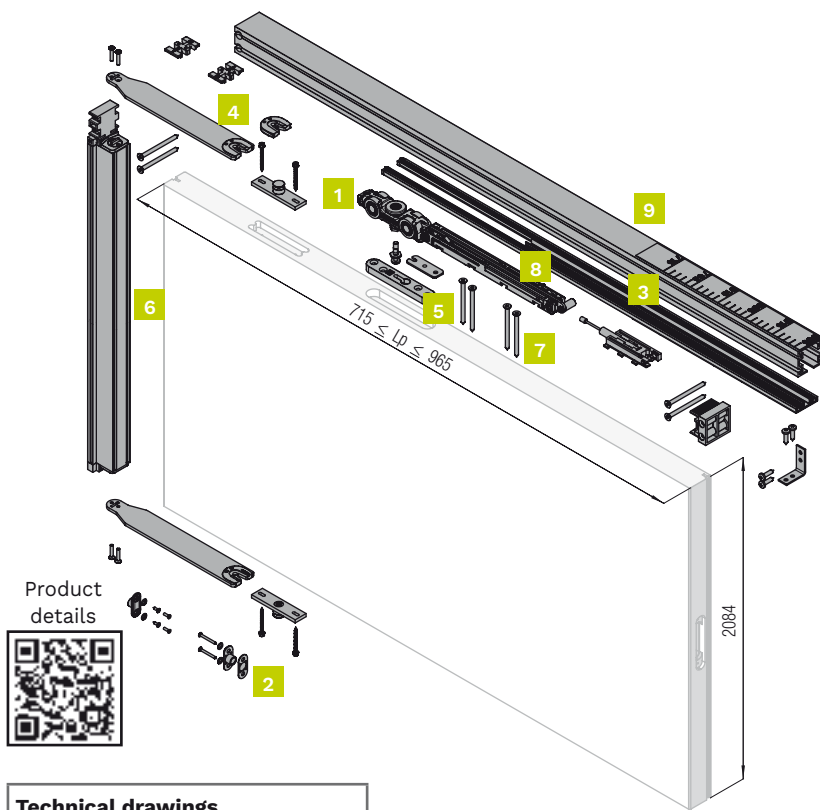

Kit components

1 door set

Figure	Component	Quantity
1	Basic SwingLife roller	1 piece
2	Magnet with support	2 pieces
3	Cover	1 piece
4	Rotating arms	2 pieces
5	Metal frame fixing plates	2 pieces
6	Vertical Beam	1 piece
7	Screws and other fixing components	1 piece
8	Soft close device (single ABS) - 80 kg	1 piece
9	Track	1 piece

Choose your set on the next page.

Technical drawings

Dimensions indicated in millimeters

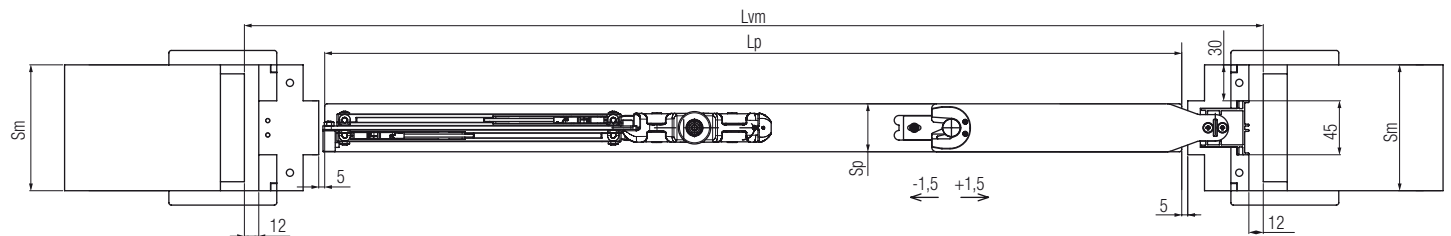

Legends and formulas

Lp= Panel width - **Hp**= Panel height - **Sp**= Panel thickness (min. 35 mm - max. 50 mm) - **Lup**= Given clear opening width = $Lp - 17 - Sp/2$ - **Hup**= Given clear opening height = $Hp + 17$ - **Lvm**= Wall opening width (pocket-frame internal space)= $Lp + 135$ - **Hvm**= Wall opening height (pocket-frame internal space)= $Hp + 66$ - **Sm**= Finished wall thickness - **Hman**= Handle height taken from the handle centre / panel bottom (standard 1041 mm) - **LT**= Cutting length of the beam = $Lp + 67$ - **LC**= Cutting length of the cover = $Lp - 210$
Note: - General measurements and siting of wood components must be made after all surface treatments such as stain, varnish, venee, etc. - Provide clearance for the brush seals, this varies depending on the type of brush or seal used.

Kit SwingLife Universal ABS

Installation examples	Dimensions tracks and accessories
<p>Dimensions indicated in millimeters</p> <p>Door leaf centered to the jamb</p> <p>Flush to the wall</p>	

How to choose the set

SwinfLife Universal is a set with a fixed height and a width to cut to size. You can find a suitable set in 3 ways: starting with the door leaf height, clear opening height or wall opening height.

Learn more about the width and height of the door, the width and height of the clear opening and the width and the height of the wall opening in the guidelines on page 189.

Door leaf width and height

Panel width (Lp)*	Panel height (Hp)	Item number.
From 715 mm to 965 mm	2034 mm	98 2034 2ABS A
From 715 mm to 965 mm	2084 mm	98 2084 2ABS A
From 715 mm to 965 mm	2384 mm	98 2384 2ABS A

*To be cut to size in the range.

Clear opening width and height

Given clear opening width (Lup)*	Given clear opening height (Hup)	Item number.
From 673 mm to 923 mm	2051 mm	98 2034 2ABS A
From 673 mm to 923 mm	2101 mm	98 2084 2ABS A
From 673 mm to 923 mm	2401 mm	98 2384 2ABS A

*To be cut to size in the range. Calculated with panel thickness of 50 mm. With lower thicknesses, the free passage width is higher.







Wall opening width and height (inside the subframe)

Wall opening width (Lvm)*	Wall opening height (Hvm)	Item number.
From 850 mm to 1100 mm	2100 mm	98 2034 2ABS A
From 850 mm to 1100 mm	2150 mm	98 2084 2ABS A
From 850 mm to 1100 mm	2450 mm	98 2384 2ABS A

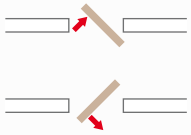
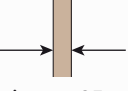
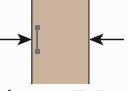
*To be cut to size in the range. Consult the guide on page 188 to identify the measurements.

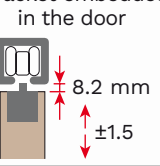
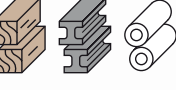
SWINGLIFE UNIVERSAL

Pivot sliding door system. Push and pull opening. Fast installation. Nylon roller. Door leaf width range: 715/965 mm. Load capacity 70 kg.

APPLICATION Swinging 	OPENING Push / Pull 	DOOR THICKNESS  minimum 35 mm maximum 50 mm	DOOR LEAF WIDTH  minimum 715 mm maximum 965 mm	TRACK  It can be cut to size based on the door width	FIXING Bracket embedded in the door  8.2 mm ±1.5	DOOR MATERIAL Wood, Metal and PVC 
SYSTEM LOAD CAPACITY Up to 70 kg 	ROLLERS Roller: Nylon Wheels: POM Ball bearings: 4 	FIXING SCREWS Included 				

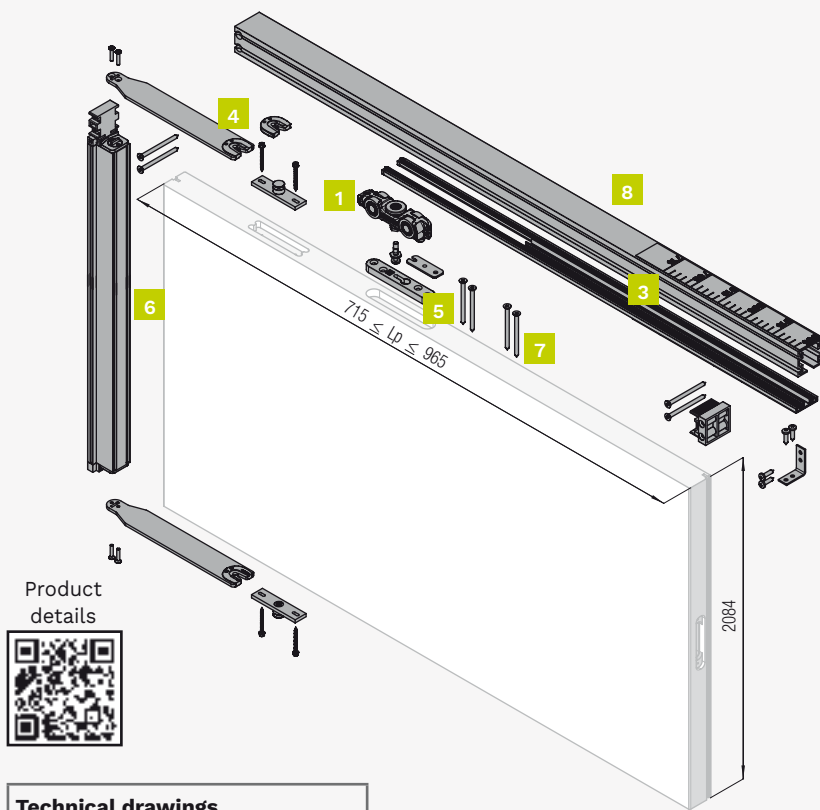

Kit components

1 door set

Figure	Component	Quantity
1	Basic SwingLife roller	1 piece
2	Magnet with support	2 pieces
3	Cover	1 piece
4	Rotating arms	2 pieces
5	Metal frame fixing plates	2 pieces
6	Vertical Beam	1 piece
7	Screws and other fixing components	1 piece
8	Track	1 piece

Choose your set on the next page.

Technical drawings

Dimensions indicated in millimeters

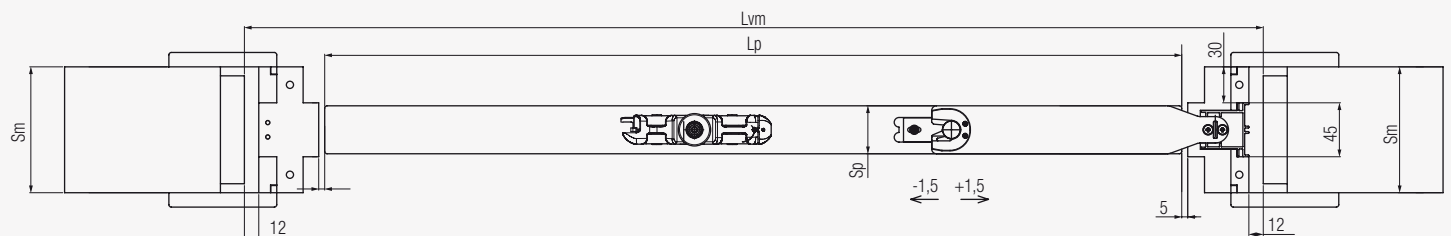

Legends and formulas

Lp= Panel width - **Hp**= Panel height - **Sp**= Panel thickness (min. 35 mm - max. 50 mm) - **Lup**= Given clear opening width = $Lp - 17 - Sp/2$ - **Hup**= Given clear opening height = $Hp + 17$ - **Lvm**= Wall opening width (pocket-frame internal space)= $Lp + 135$ - **Hvm**= Wall opening height (pocket-frame internal space)= $Hp + 66$ - **Sm**= Finished wall thickness - **Hman**= Handle height taken from the handle centre / panel bottom (standard 1041 mm) - **LT**= Cutting length of the beam = $Lp + 67$ - **LC**= Cutting length of the cover = $Lp - 210$
Note: - General measurements and siting of wood components must be made after all surface treatments such as stain, varnish, venee, etc. - Provide clearance for the brush seals, this varies depending on the type of brush or seal used.

Kit SwingLife Universal

Installation examples	Dimensions tracks and accessories
<p>Dimensions indicated in millimeters</p> <p style="text-align: center;">Door leaf centered to the jamb</p> <p style="text-align: center;">Flush to the wall</p>	

How to choose the set

SwinfLife Universal is a set with a fixed height and a width to cut to size. You can find a suitable set in 3 ways: starting with the door leaf height, clear opening height or wall opening height.

Learn more about the width and height of the door, the width and height of the clear opening and the width and the height of the wall opening in the guidelines on page 189.

Door leaf width and height

Door leaf width(Lp)*	Panel height (Hp)	Item number.
From 715 mm to 965 mm	2034 mm	98 2034 OABS A
From 715 mm to 965 mm	2084 mm	98 2084 OABS A
From 715 mm to 965 mm	2384 mm	98 2384 OABS A

*To be cut to size in the range.

Clear opening width and height

Given clear opening width (Lup)*	Given clear opening height (Hup)	Item number.
From 673 mm to 923 mm	2051 mm	98 2034 OABS A
From 673 mm to 923 mm	2101 mm	98 2084 OABS A
From 673 mm to 923 mm	2401 mm	98 2384 OABS A

*To be cut to size in the range. Calculated with panel thickness of 50 mm. With lower thicknesses, the free passage width is higher.

Wall opening width and height (inside the subframe)

Wall opening width (Lvm)*	Wall opening height (Hvm)	Item number.
From 850 mm to 1100 mm	2100 mm	98 2034 OABS A
From 850 mm to 1100 mm	2150 mm	98 2084 OABS A
From 850 mm to 1100 mm	2450 mm	98 2384 OABS A

*To be cut to size in the range. Consult the guide on page 188 to identify the measurements.

[TECHNICAL GUIDES] HOW TO INTERPRET AND CORRELATE WIDTHS AND HEIGHTS SWINGLIFE STANDARD

HOW TO IDENTIFY THE WIDTH

Door leaf width of 565mm, 665mm, 715mm, 765mm, 815mm, 915mm is available for SwingLife Standard version.

The table below shows how the given clear opening width and the wall opening width change in the possible door leaf sizes.

How do you read the table?

The table is bidirectional. Based on your starting point (door leaf width, given clear opening width or wall opening width), you can find out the dimensions of the other widths.

Example: If I have a wall opening with the width of 900 mm, the door leaf must be 765 mm and its clear opening will be 723 mm with a 50 mm thick door leaf.

Panel width (Lp)	Given clear opening width (Lup)*	Wall opening width (Lvm)
565 mm	523 mm	700 mm
665 mm	623 mm	800 mm
715 mm	673 mm	850 mm
765 mm	723 mm	900 mm
815 mm	773 mm	950 mm
915 mm	878 mm	1050 mm

*Calculated with door leaf thickness of 50 mm. With smaller thicknesses, the given clear opening width is larger.

How to calculate the given clear opening width (Lup)?

The given clear opening width is calculated according to the following formula: $Lp - 17 - Sp/2$

How to calculate the wall opening width (Lvm)?

The wall opening width is calculated according to the following formula: $Lp + 135 \text{ mm}$

HOW TO IDENTIFY THE HEIGHT

In the SwingLife Universal version the available door leaf heights are 2034 mm and 2084 mm.

In the below table it is indicated how the clear opening height and the wall opening height change depending on the height options.

How do you read the table?

The table is bidirectional. Based on your starting point (door leaf height, given clear opening height or wall opening height), you can find out the dimensions of the other heights.

Example: If your wall opening is 2150 mm high, the door leaf must be 2084 mm high and the clear opening will be 2101 mm.

Panel height (Hp)	Given clear opening height (Hup)*	Wall opening height (Hvm)
2034 mm	2051 mm	2100 mm
2084 mm	2101 mm	2150 mm

How to calculate the given clear opening height (Hup)?

The given clear opening height is calculated according to the following formula: $Hp + 17 \text{ mm}$

How to calculate the wall opening height (Hvm)?

The wall opening height is calculated according to the following formula: $Hp + 66 \text{ mm}$

HOW TO INTERPRET WIDTHS AND HEIGHTS

Widths

[Lp] Panel width

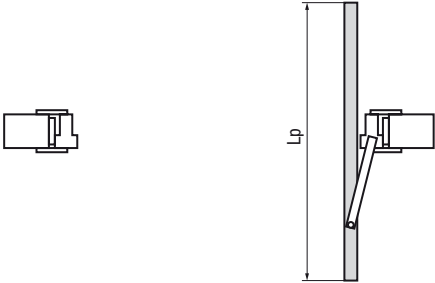

[Lup] Given clear opening width

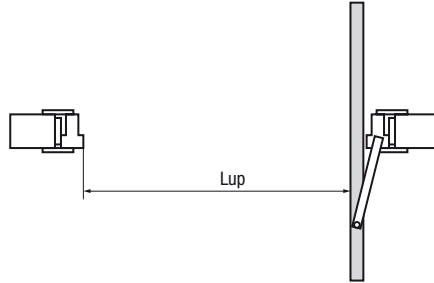

[Lvm] Wall opening width

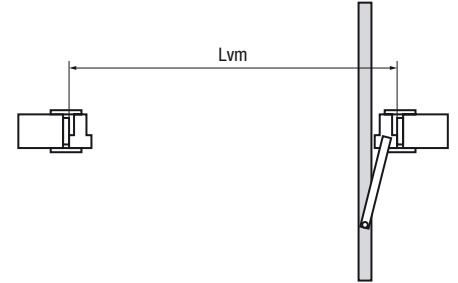

Heights

[Hp] Panel height

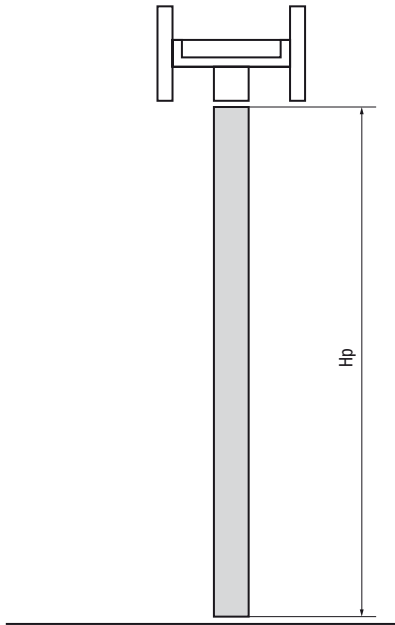

[Hup] Given clear opening height

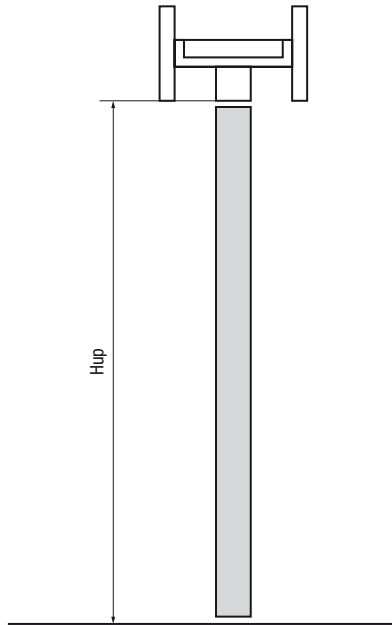



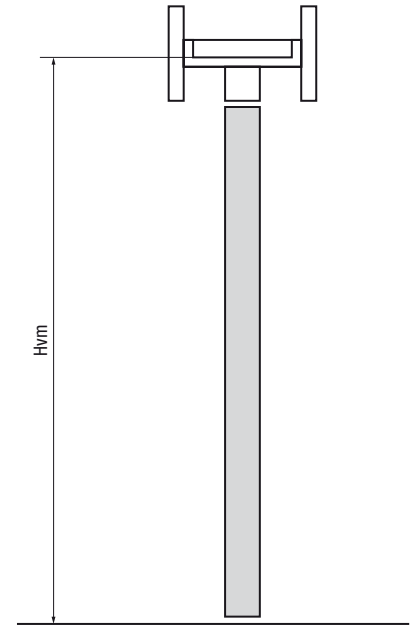



[Hvm] Wall opening height

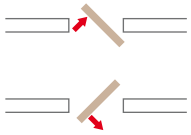
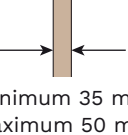

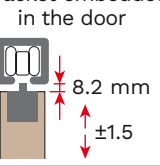
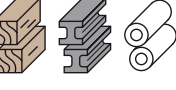
SWINGLIFE STANDARD ABS

Pivot sliding door system. Push and pull opening. Fast installation. Single ABS. Nylon roller. Door leaf width range: 665/915 mm. Load capacity 70 kg.

APPLICATION Swinging 	OPENING Push / Pull 	DOOR THICKNESS  minimum 35 mm maximum 50 mm	DOOR LEAF WIDTH  Options varying from: minimum 665 mm maximum 915 mm	TRACK  Standard length based on the door width	FIXING Bracket embedded in the door  8.2 mm ±1.5	DOOR MATERIAL Wood, Metal and PVC 
SYSTEM LOAD CAPACITY Up to 70 kg 	ROLLERS Roller: Nylon Wheels: POM Ball bearings: 4 	SOFT-CLOSE ABS ●●●●●●●● SINGLE Type: Mechanic Covering: Plastic	FIXING SCREWS Included 			

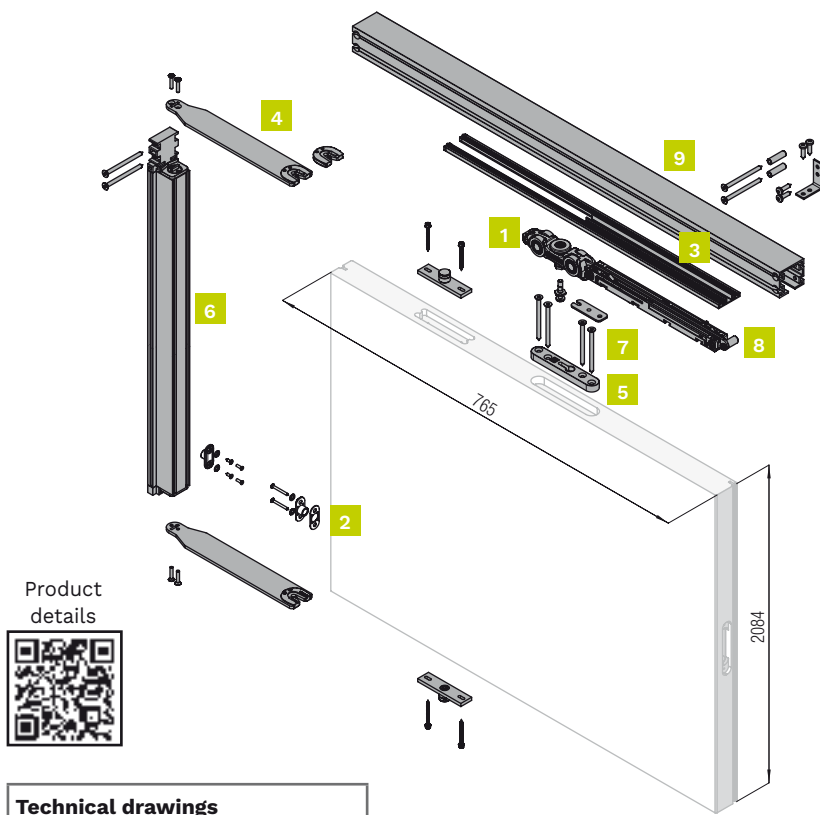

Kit components

1 door set

Figure	Component	Quantity
1	Basic SwingLife roller	1 piece
2	Magnet with support	2 pieces
3	Cover	1 piece
4	Rotating arms	2 pieces
5	Metal frame fixing plates	2 pieces
6	Vertical Beam	1 piece
7	Screws and other fixing components	1 piece
8	Soft close device (single ABS) - 80 kg	1 piece
9	Track	1 piece

Choose your set on the next page.

Technical drawings

Dimensions indicated in millimeters

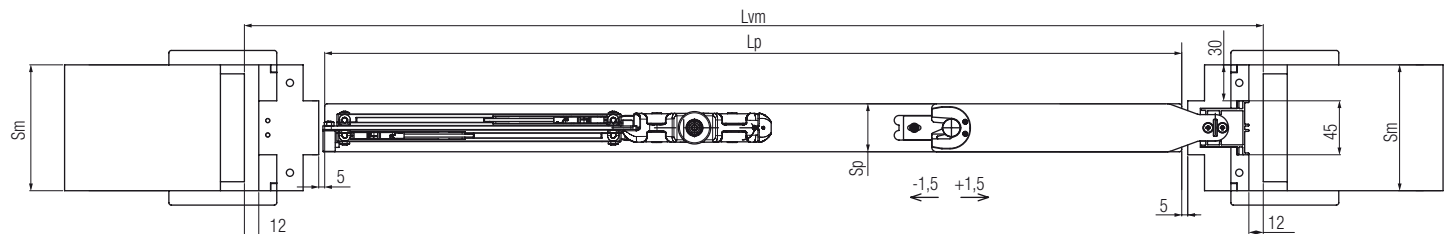

Legends and formulas

Lp= Panel width - **Hp**= Panel height - **Sp**= Panel thickness (min. 35 mm - max. 50 mm) - **Lup**= Given clear opening width = $Lp - 17 - Sp/2$ - **Hup**= Given clear opening height = $Hp + 17$ - **Lvm**= Wall opening width (pocket-frame internal space)= $Lp + 135$ - **Hvm**= Wall opening height (pocket-frame internal space)= $Hp + 66$ - **Sm**= Finished wall thickness - **Hman**= Handle height taken from the handle centre / panel bottom (standard 1041 mm)

Note: - General measurements and siting of wood components must be made after all surface treatments such as stain, varnish, veneer, etc. - Provide clearance for the brush seals, this varies depending on the type of brush or seal used.

Kit SwingLife Standard ABS

Installation examples	Dimensions tracks and accessories
<p>Dimensions indicated in millimeters</p> <p>Door leaf centered to the jamb</p> <p>Flush to the wall</p>	

How to choose the set

SwinLife Standard is a set for a fixed width and height. You can find a suitable set in 3 ways: starting with the door leaf width and height, clear opening width and height or wall opening width and height.

Learn more about the width and height of the door, the width and height of the clear opening and the width and the height of the wall opening in the guidelines on page 195.

Door leaf width and height

Panel width (Lp)	Panel height (Hp)	Item number.
665 mm	2084 mm	97 665 2084 2ABS A
715 mm	2084 mm	97 715 2084 2ABS A
765 mm	2084 mm	97 765 2084 2ABS A
815 mm	2084 mm	97 815 2084 2ABS A
915 mm	2084 mm	97 915 2084 2ABS A

For other dimensions see the SwingLife Universal version or contact Krona Koblenz.

Clear opening width and height

Given clear opening width (Lup)*	Given clear opening height (Hup)	Item number.
623 mm	2101 mm	97 665 2084 2ABS A
673 mm	2101 mm	97 715 2084 2ABS A
723 mm	2101 mm	97 765 2084 2ABS A
773 mm	2101 mm	97 815 2084 2ABS A
873 mm	2101 mm	97 915 2084 2ABS A

*Calculated with door leaf thickness of 50 mm. With smaller thicknesses, the given clear opening width is larger. For other dimensions see the SwingLife Universal version or contact Krona Koblenz.







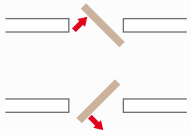

Wall opening width and height (inside the subframe)

Wall opening width (Lvm)	Wall opening height (Hvm)	Item number.
800 mm	2150 mm	97 665 2084 2ABS A
850 mm	2150 mm	97 715 2084 2ABS A
900 mm	2150 mm	97 765 2084 2ABS A
950 mm	2150 mm	97 815 2084 2ABS A
1050 mm	2150 mm	97 915 2084 2ABS A

For other dimensions see the SwingLife Universal version or contact Krona Koblenz.

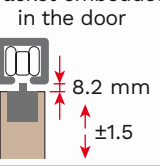
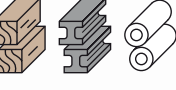
SWINGLIFE STANDARD

Pivot sliding door system. Push and pull opening. Fast installation. Nylon roller. Door leaf width range: 565/915 mm. Load capacity 70 kg.

APPLICATION Swinging 	OPENING Push / Pull 	DOOR THICKNESS  minimum 35 mm maximum 50 mm	DOOR LEAF WIDTH  Options varying from: minimum 565 mm maximum 915 mm	TRACK  Standard length based on the door width	FIXING Bracket embedded in the door  8.2 mm ±1.5	DOOR MATERIAL Wood, Metal and PVC 
SYSTEM LOAD CAPACITY Up to 70 kg 	ROLLERS Roller: Nylon Wheels: POM Ball bearings: 4 	FIXING SCREWS Included 				

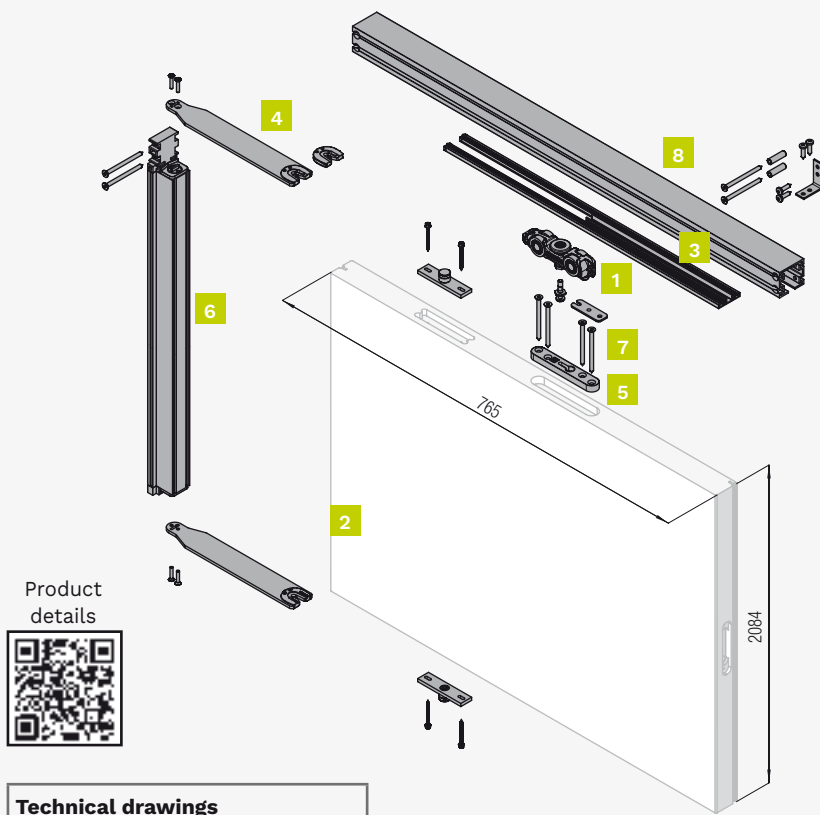

Kit components

1 door set

Figure	Component	Quantity
1	Basic SwingLife roller	1 piece
2	Magnet with support	2 pieces
3	Cover	1 piece
4	Rotating arms	2 pieces
5	Metal frame fixing plates	2 pieces
6	Vertical Beam	1 piece
7	Screws and other fixing components	1 piece
8	Track	1 piece

Choose your set on the next page.

Technical drawings

Dimensions indicated in millimeters

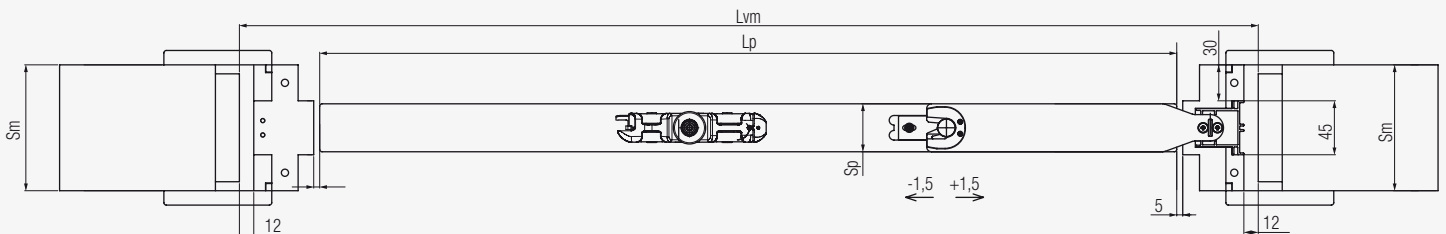

Legends and formulas

Lp= Panel width - **Hp**= Panel height - **Sp**= Panel thickness (min. 35 mm - max. 50 mm) - **Lup**= Given clear opening width = $Lp - 17 - Sp/2$ - **Hup**= Given clear opening height = $Hp + 17$ - **Lvm**= Wall opening width (pocket-frame internal space)= $Lp + 135$ - **Hvm**= Wall opening height (pocket-frame internal space)= $Hp + 66$ - **S**= Finished wall thickness - **Hman**= Handle height taken from the handle centre / panel bottom (standard 1041 mm)

Note: - General measurements and siting of wood components must be made after all surface treatments such as stain, varnish, veneer, etc. - Provide clearance for the brush seals, this varies depending on the type of brush or seal used.

Kit SwingLife Standard

Installation examples	Dimensions tracks and accessories
<p>Dimensions indicated in millimeters</p> <p>Door leaf centered to the jamb</p> <p>Flush to the wall</p>	<p>45</p> <p>40,8</p> <p>70 kg</p>

How to choose the set

SwinLife Standard is a set for a fixed width and height. You can find a suitable set in 3 ways: starting with the door leaf width and height, clear opening width and height or wall opening width and height.

Learn more about the width and height of the door, the width and height of the clear opening and the width and the height of the wall opening in the guidelines on page 195.

Door leaf width and height

Panel width (Lp)	Panel height (Hp)	Item number.
565 mm	2034 mm	97 565 2034 OABS A
665 mm	2084 mm	97 665 2084 OABS A
715 mm	2084 mm	97 715 2084 OABS A
765 mm	2084 mm	97 765 2084 OABS A
815 mm	2084 mm	97 815 2084 OABS A
915 mm	2084 mm	97 915 2084 OABS A

For other dimensions see the SwingLife Universal version or contact Krona Koblenz.

Clear opening width and height

Given clear opening width (Lup)*	Given clear opening height (Hup)	Item number.
523 mm	2051 mm	97 565 2034 OABS A
623 mm	2101 mm	97 665 2084 OABS A
673 mm	2101 mm	97 715 2084 OABS A
723 mm	2101 mm	97 765 2084 OABS A
773 mm	2101 mm	97 815 2084 OABS A
873 mm	2101 mm	97 915 2084 OABS A

*Calculated with door leaf thickness of 50 mm. With smaller thicknesses, the given clear opening width is larger. For other dimensions see the SwingLife Universal version or contact Krona Koblenz.

Wall opening width and height (inside the subframe)

Wall opening width (Lvm)	Wall opening height (Hvm)	Item number.
700 mm	2100 mm	97 565 2034 OABS A
800 mm	2150 mm	97 665 2084 OABS A
850 mm	2150 mm	97 715 2084 OABS A
900 mm	2150 mm	97 765 2084 OABS A
950 mm	2150 mm	97 815 2084 OABS A
1050 mm	2150 mm	97 915 2084 OABS A

For other dimensions see the SwingLife Universal version or contact Krona Koblenz.

Accessories	
Component	Item number.
Black anti-dust brus	9700 6 N
Grey gasket	9700 8 G
Black gasket	9700 8 N
Soft close device (single ABS) - 80 kg	9700 9
Soft close device (single ABS) - 80 kg	9700 10

Spare parts			
Component	*Quantity	Item number.	Which set is it for?
Kit with plastic components	1 piece	9700 1	<i>SwingLife: Universal ABS, Universal, Standard ABS, Standard</i>
Screws kit	1 piece	9700 2	<i>SwingLife: Universal ABS, Universal, Standard ABS, Standard</i>
Basic SwingLife roller	1 piece	9700 3	<i>SwingLife: Universal ABS, Universal, Standard ABS, Standard</i>
Damper with support	1 piece	9700 4	<i>SwingLife: Universal ABS, Universal, Standard ABS, Standard</i>
Magnets kit	1 piece	9700 5	<i>SwingLife: Universal ABS, Universal, Standard ABS, Standard</i>
Silver cover	1 piece	9700 7 A	<i>SwingLife: Universal ABS, Universal, Standard ABS, Standard</i>
Black cover	1 piece	9700 7 N	<i>SwingLife: Universal ABS, Universal, Standard ABS, Standard</i>
Set of rotating arms Lp>965	1 piece	9700 13 L	<i>SwingLife: Universal ABS, Universal, Standard ABS, Standard</i>
Set of rotating arms 715<Lp<965	1 piece	9700 13 M	<i>SwingLife: Universal ABS, Universal, Standard ABS, Standard</i>
Set of rotating arms Lp<715	1 piece	9700 13 S	<i>SwingLife: Universal ABS, Universal, Standard ABS, Standard</i>
Set of metal frame fixing plates	1 piece	9700 14	<i>SwingLife: Universal ABS, Universal, Standard ABS, Standard</i>

*The minimum order quantity is indicated.

The illustrations, photos, images and technical data, features and colours of the catalogue are purely indicative and are not binding for Krona Koblenz. The deviations cannot create any reasons for not accepting the goods or compromise the contract or cause claims. All the models can be altered, improved or slightly modified in their sections, structure or drawing without any previous notification. Therefore, if at our incontestable discretion the quality and the look of our products remain unchanged, a customer will not be able either to terminate the contract or to have particular discounts or bonus.

K Krona Koblenz

OFFICES AND CONTACTS

Headquarter

ITALY

Krona Koblenz SpA

+39 0541 657040

E-mail: info@k-group.com

Via Piane, 90
47853 Coriano (RN)

SPAIN

Krona Koblenz S.L.

+34 93 591 0410

E-mail: info@k-group.com

P.I. MOLI D'EN XEC NAVE n P3-3/6
_ c/ Moli d' en Xec, n 49/55
C.P. 08291 Ripollet - (Barcelona)

FRANCE

Krona Koblenz Sas

+33-474090939

E-mail: info@k-group.com

Saint Georges De Reneins (69830)
635 Boulevard Napoléon
Bullukian

RUSSIA

Крона Кобленц ООО

+7 (495) 532-74-32

E-mail: info@kronakoblenz.ru

117623, Москва,
Варшавское шоссе,
дом 268, строение 1, блок А11

INDIA

Koblenz Utturkar
Fittings Private Limited

+91 020 24540000

E-mail: info@k-group.com

FLAT No. 3, 1875, Sadashiv Peth,
Shree Balaji Prasad Society,
Pune - 411030, Maharashtra



www.kronakoblenz.com



@krona_koblenz



@Krona Koblenz



@Krona Koblenz



@Kronakoblenz