



Essential timber

SF-P50 | SF-A60 | SF-P70 | SF-A90 |
SF-RA P50 | SF-RA A60 | SF-RA P70 | SF-RA A90

ESSENTIAL TIMBER

ES

CREA ESPACIOS CON NUESTRA GAMA DE IMPRESCINDIBLES, LOS BÁSICOS QUE SIEMPRE ESTÁN DE MODA Y TENDENCIA.

Star, una única guía y múltiples opciones para aplicaciones de puertas de paso:

1.Instalación a pared o techo, con perfil visto o a falso techo para un diseño totalmente minimalista. 2.Acabados en aluminio anodizado plata mate y lacado negro y blanco mate para su mejor adaptación a las exigencias arquitectónicas. 3.Diseño liso y elegante. 4.Perfil separador con geometría pensada para ahorrar tiempo en instalación. 5.Solución para paneles de hasta 90Kg. 6.Distintas opciones de rodamiento: a fricción o a bolas, ambas silenciosas y con un mínimo de esfuerzo de deslizamiento. 7.Posibilidad de freno amortiguador (Softbrake) para un cierre suave y sin impactos. 8.Certificado de calidad Applus según la norma EN 1527.

EN

CREATE SPACES WITH OUR RANGE OF ESSENTIALS, THE BASICS THAT ARE ALWAYS TRENDY.

Star, a single track with multiple options for doorway applications:

1.Wall or ceiling installation, using an exposed or false ceiling concealed track for an entirely minimalist design. 2.Satin anodized aluminum and matt black or white lacquered finishes for a better adaptation to architectural requirements. 3.Smooth and elegant design. 4.Wall mounting profile designed to save installation time. 5.Solution for panels up to 90Kg. 6.Various rolling options: friction or ball bearing, both silent and effortless sliding. 7.Soft closing feature available for a soft and impact-free closing. 8.Applus quality certificate according to EN 1527 standard.

FR

CRÉEZ DES ESPACES AVEC NOTRE GAMME D'INCONTOURNABLES, LES BASIQUES TOUJOURS TENDANCE.

Star, un seul rail avec plusieurs options pour les applications de portes coulissantes intérieures:

1.Installation en applique au plafond ou au mur avec une profil visible, ou installation avec rail encastrée dans le faux plafond. 2.Finitions en aluminium anodisé argent et laquée noir mat ou blanc pour une meilleure adaptation aux exigences architecturales. 3.Design lisse et élégant. 4.Rail support mural conçu pour gagner du temps d'installation. 5.Solution pour panneaux jusqu'à 90Kg. 6.Différentes options de roulement: roulement à billes ou à friction, à la fois silencieux et avec un effort de coulissement minime. 7.Fermeture en douceur (Amortisseur) disponible pour une fermeture douce et sans impact. 8.Certificat de qualité Applus selon EN 1527.

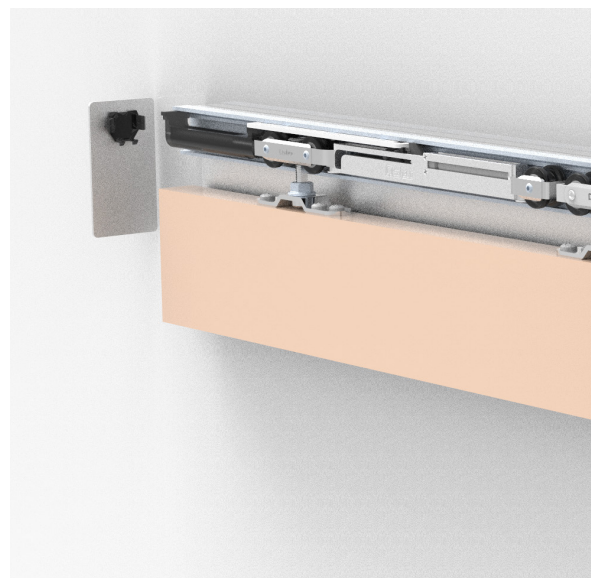
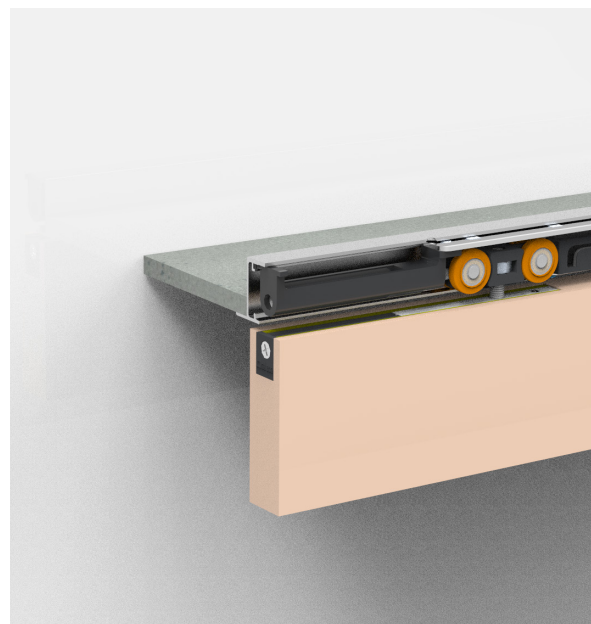

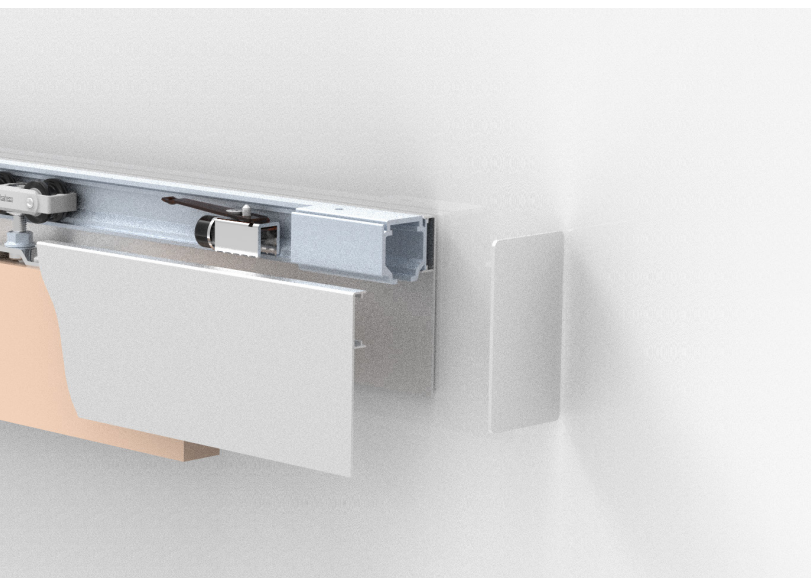
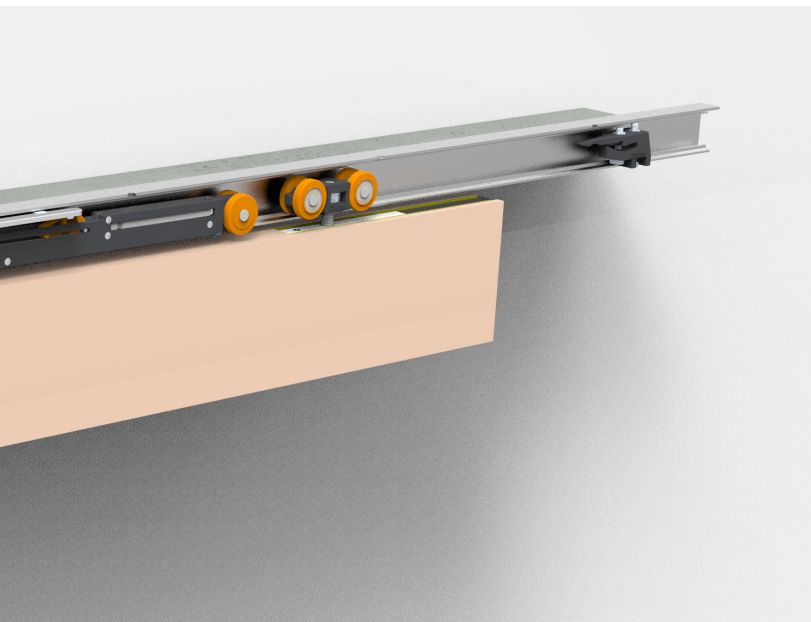
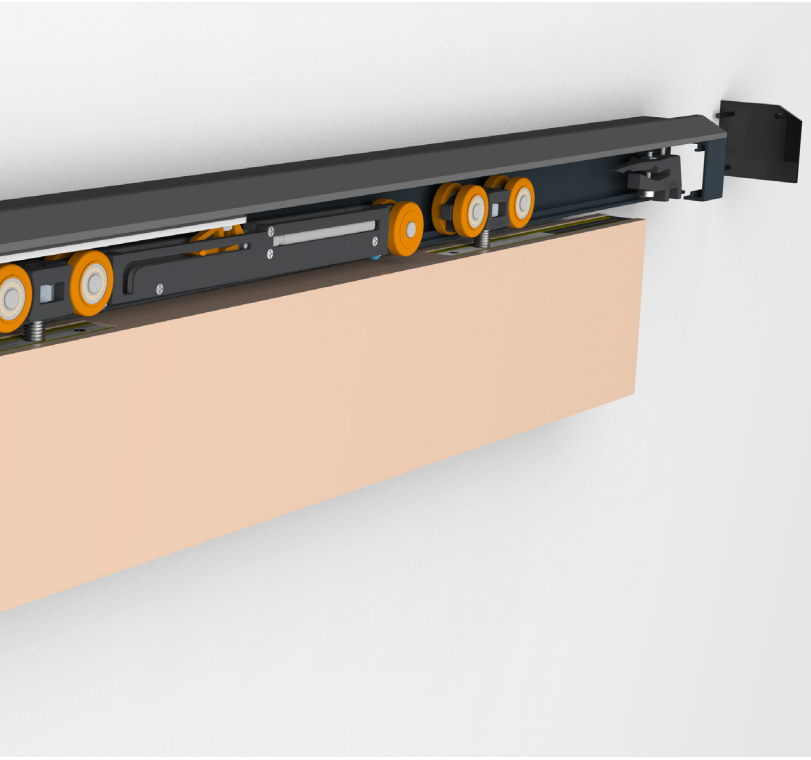

Características técnicas

Technical characteristics | Caractéristiques techniques

Perfilería Profiles | Profils

STANDARD



30x29mm
no admite softbrake

EXCELLENCE



33x33mm

STAR



33x32,3mm

PERFIL SEPARADOR
STAR / EXCELLENCE



49x43,3mm

STAR FT

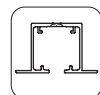

53x32,3mm

Especificaciones Specifications | Spécification

SF-P70 | SF-RA P70
SF-A90 | SF-RA A90



Sin Softbrakes
MÍN. 600 mm

SF-P70 | SF-RA P70



1 Softbrake
MÍN. 600 mm
2 Softbrakes
MÍN. 800 mm

SF-A90

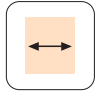

1 Softbrake
MÍN. 600 mm
2 Softbrakes
MÍN. 825 mm

SF-RA A90

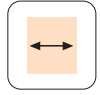

1 Softbrake
MÍN. 615 mm
2 Softbrakes
MÍN. 850 mm



MÍN. 27 mm



SOFTBRAKE
MÁX.90Kg



RODAMIENTO
A BOLAS
BALL BEARING



FORMATO KIT
DISPONIBLE

Peso Weights | Poids

50 kg	110 lb
60 kg	132 lb
70 kg	154 lb
90 kg	198 lb

Producto certificado

certificatd | Product produit certifié





Variantes de instalación

Installation possibilities | Variantes d'installation

PARED

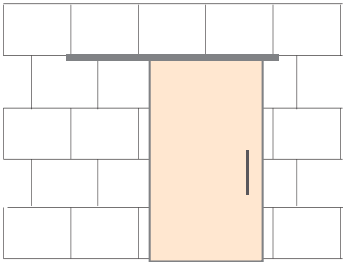

TECHO

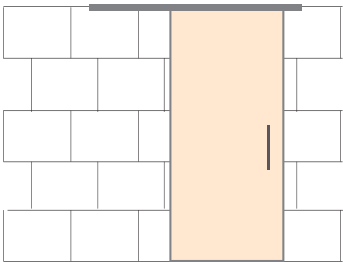

FALSO TECHO

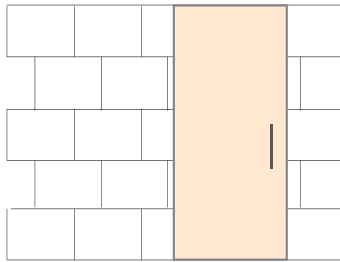



Sección tipo

Cross-section | Section type (Cotas en mm | Dimensions in mm | Dimensions en mm)

MONTAJE A TECHO | CEILING MOUNT | FIXATION À TOIT



STANDARD
no admite
softbrake



EXCELLENCE

OPCIÓN PLETINA
PLATE OPTION | OPTION PLAQUE

OPCIÓN RA
RA OPTION | OPTION RA

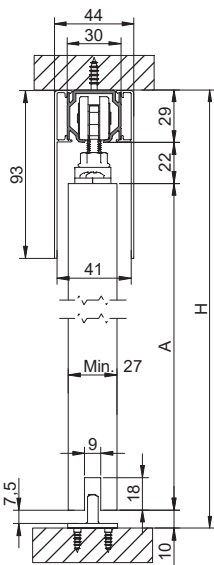
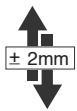

STANDARD
A= H-61

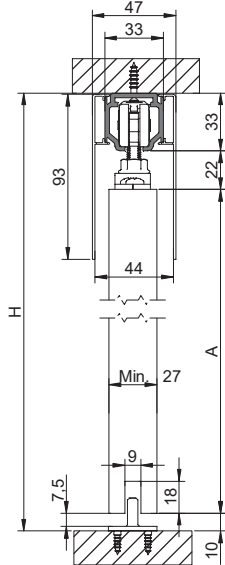

EXCELLENCE
A= H-65

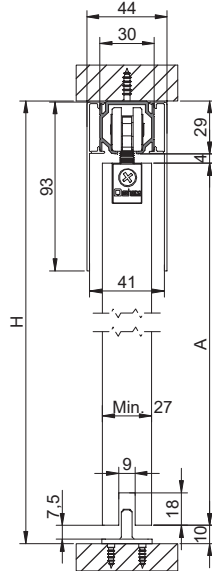
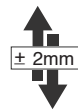

STANDARD
A= H-43

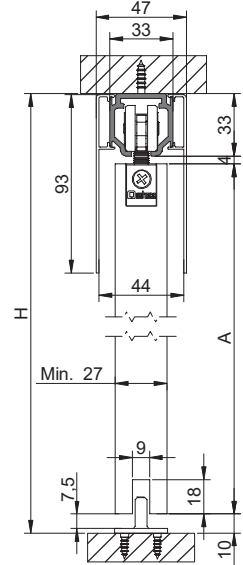

EXCELLENCE
A= H-47



STAR

OPCIÓN PLETINA
PLATE OPTION | OPTION PLAQUE

OPCIÓN RA
RA OPTION | OPTION RA

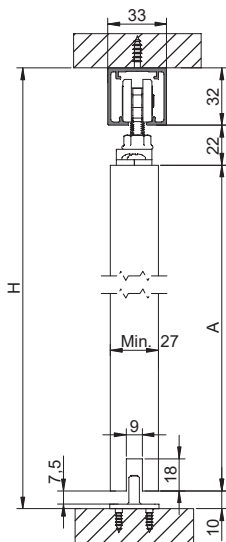
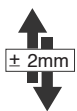

A= H-65

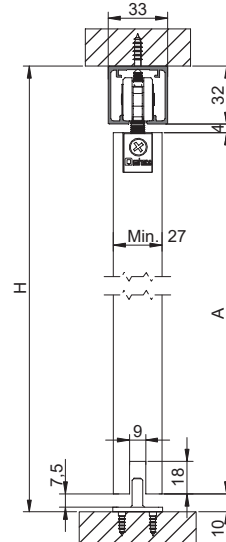
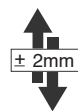

A= H-47



Sección tipo Cross-section

(Cotas en mm | Dimensions in mm | Dimensions en mm)

MONTAJE A PARED | WALL MOUNT | FIXATION À MUR



OPCIÓN PLETINA
 PLATE OPTION | OPTION PLAQUE

STANDARD
 no admite
 softbrake

EXCELLENCE

REF.:006059

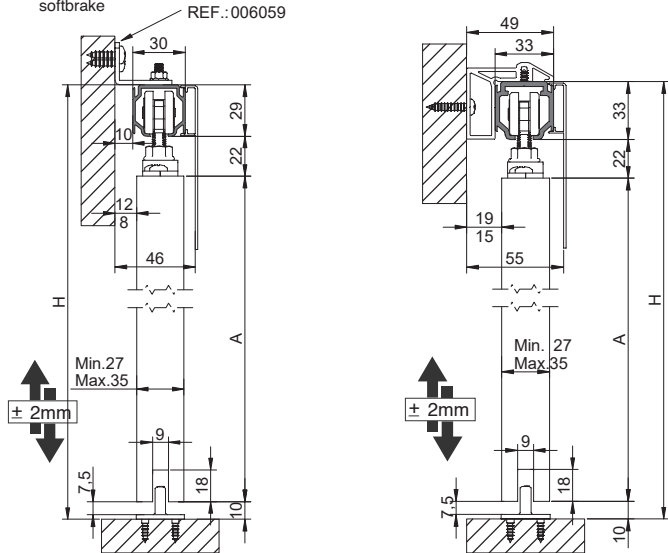

STANDARD
 A= H-61

**EXCELLENCE +
 PERFIL SEPARADOR**
 A= H-65

OPCIÓN RA
 RA OPTION | OPTION RA

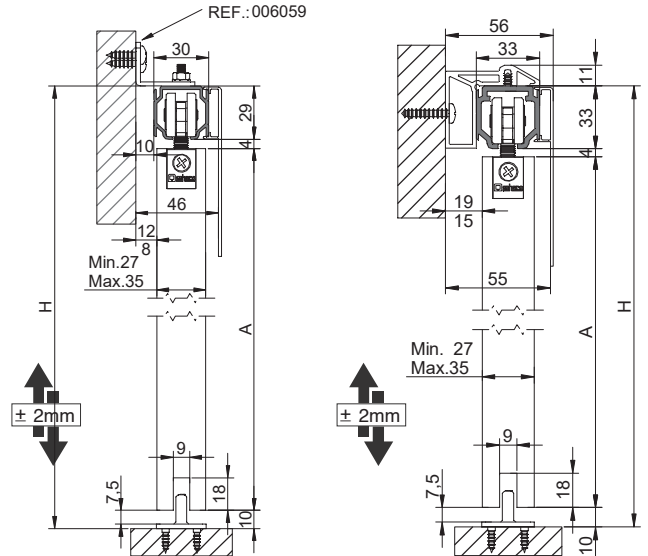

STANDARD
 A= H-43

**EXCELLENCE +
 PERFIL SEPARADOR**
 A= H-47



OPCIÓN PLETINA
 PLATE OPTION | OPTION PLAQUE

STAR

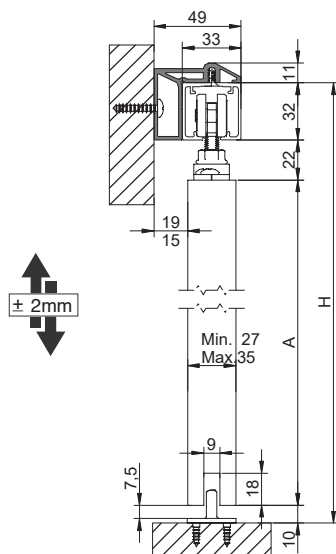

**STAR +PERFIL
 SEPARADOR**
 A= H-65

OPCIÓN RA
 RA OPTION | OPTION RA

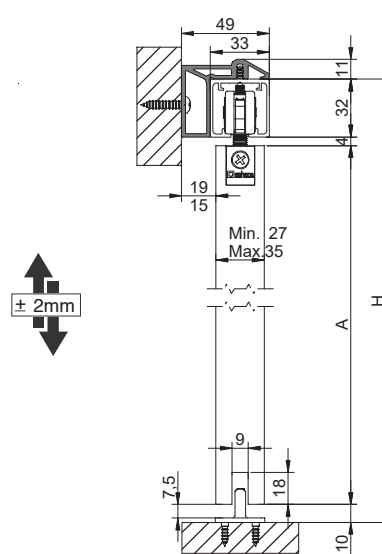

**STAR +PERFIL
 SEPARADOR**
 A= H-47



Sección tipo Cross-section

(Cotas en mm | Dimensions in mm | Dimensions en mm)

MONTAJE A FALSO TECHO | FALSE CEILING MOUNT | FIXATION À PLAFOND



STAR FT

OPCIÓN PLETINA
PLATE OPTION | OPTION PLAQUE

OPCIÓN RA
RA OPTION | OPTION RA

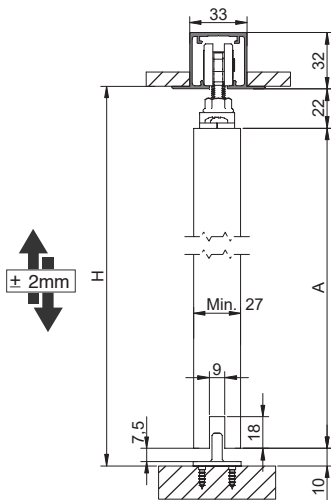

A= H-32

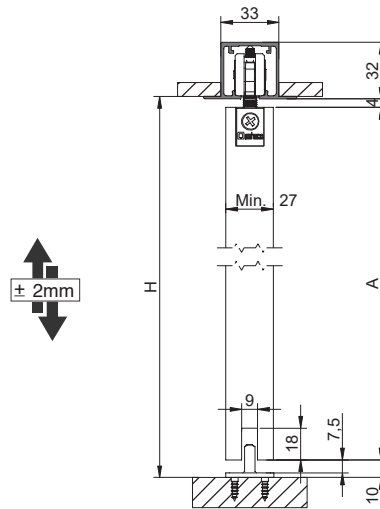

A= H-14



Componentes

Components

PERFILERÍA PROFILES PROFILS		Finished	Cód.			€/Unit
 <p>Perfil guía superior Standard Standard Top track Rail haut standard</p> <p>80kg </p> <p>30x29mm no admite softbrake</p>	<p>S</p> <p>MF</p>	00 60 20	2 m	6 perfiles 6 profiles 6 profils	23,30	
		00 60 30	3 m		34,95	
00 60 50	5 m	58,25				
00 61 20	2 m	19,28				
00 61 30	3 m	28,92				
00 61 50	5 m	48,20				
 <p>Perfil guía superior Excellence. Montaje a techo Excellence Top track, drilled for ceiling mounting Rail haut Excellence percé à plafond</p> <p>90kg </p> <p>33x33mm</p>	<p>S</p> <p>MF</p>	0 105 24	2 m	2 perfiles 2 profiles 2 profils	33,02	
		0 105 34	3 m		49,53	
		0 105 54	5 m		82,55	
		0 105 23	2 m		28,08	
		0 105 33	3 m		42,12	
		0 105 53	5 m		70,20	
 <p>Perfil guía superior Star, montaje a techo Star top track. Ceiling mounting Rail haut Star pour fixation à plafond</p> <p>90kg </p> <p>33x32,3mm</p>	<p>S</p> <p>MF</p> <p>BL</p>	00 82 20	2 m	6 perfiles 6 profiles 6 profils	27,68	
		00 82 30	3 m		41,52	
00 82 50	5 m	69,20				
00 82 23 ¹	2 m	16,68				
00 82 33 ¹	3 m	25,02				
00 82 53 ¹	5 m	41,70				
		00 82 24	2 m		33,50	
		00 82 34	3 m		50,25	
		00 82 54	5 m		83,75	
 <p>Perfil guía superior Star FT, montaje a falso techo Star FT top track for false ceilings Profil Star FT pour installation à faux-plafond</p> <p>90kg </p> <p>53x32,3mm</p>	<p>S</p> <p>BL</p> <p>WL</p>	00 82 25	2 m	2 perfiles 2 profiles 2 profils	29,86	
		00 82 35	3 m		44,79	
00 82 55	5 m	74,65				
00 82 26	2 m	36,14				
00 82 36	3 m	54,21				
00 82 56	5 m	90,35				
		00 82 21	2 m		36,14	
		00 82 31	3 m		54,21	
		00 82 51	5 m		90,35	
 <p>Perfil superior separador Star / Excellence, montaje a pared Star / Excellence Full width side fixing profile Profil équerre pour fixation murale Star / Excellence</p> <p></p> <p>49x43,3mm</p>	<p>S</p> <p>BL</p>	00 82 27 ²	2 m	1 perfil 1 profile 1 profil	38,76	
		00 82 37 ²	3 m		58,14	
00 82 57 ²	5 m	96,90				
00 82 28 ²	2 m	46,90				
00 82 38 ²	3 m	70,35				
00 82 58 ²	5 m	117,25				

¹ Se sirve sin mecanizar | Is served without machining | Est servi sans usinage

² Para perfil superior separador **Star / Excellence**, montaje a pared de 2 m, 3 m, 5 m | *For Star / Excellence Full width side fixing profile 2m, 3m or 5m | *Pour profil équerre pour fixation murale Star / Excellence 2m, 3m ou 5m.

2 m 10 tornillos | screw | vis
3 m 15 tornillos | screw | vis
5 m 25 tornillos | screw | vis

S Aluminio anodizado plata mate
Satin anodized aluminium
Aluminium anodisé argent

MF Aluminio natural
Mill finish aluminium
Aluminium brut

BL Aluminio lacado negro mate
Matt black lacquered aluminium
Aluminium anodisé laqué noir mat

WL Aluminio lacado blanco mate
Matt white lacquered aluminium
Aluminium anodisé laqué blanc mat



Componentes



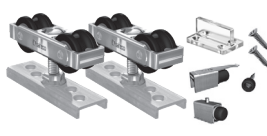
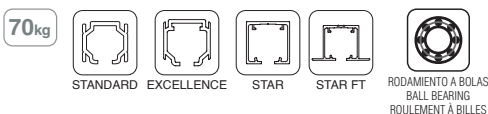
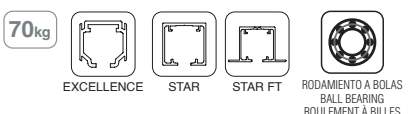







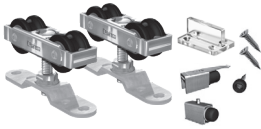





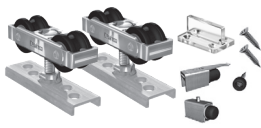











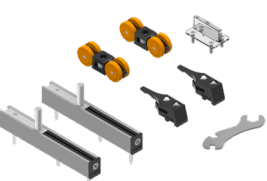

Components

JUEGOS SETS JEUX	Finished	Cód.			€/Unit
<p>OPCIÓN PLETINA PLATE OPTION OPTION PLAQUE</p>  <p>Juego SF-P50 pletina sobrepuesta. Doble freno retenedor SF-P50 Fitting set with face fixed mounting plate and double retaining brake Garniture SF-P50 avec plaque à visser. Double frein de retenu</p> <p>50kg</p> 		00 52 00		10 juegos 10 sets 10 jeux	15,85
 <p>Juego de accesorios SF-A60 (pletina 00 60 53) SF-A60 Fitting set 1 door (plate 00 60 53) Garniture SF-A61 1 porte (plaque 00 60 53)</p> <p>60kg</p> 		00 61 00		10 juegos 10 sets 10 jeux	20,65
 <p>Juego de accesorios SF-A60 (pletina 00 60 60) SF-A60 Fitting set 1 door (plate 00 60 60) Garniture SF-A60 1 porte (plaque 00 60 60)</p> <p>60kg</p> 		00 61 01		10 juegos 10 sets 10 jeux	20,65
 <p>Juego SF-P70 pletina sobrepuesta. Doble freno retenedor SF-P70 Fitting set with face fixed mounting plate and double retaining brake Garniture SF-P70 avec plaque à visser. Double frein de retenu</p> <p>70kg</p> 		00 72 00		10 juegos 10 sets 10 jeux	17,90
 <p>Juego SF-P70. Softbrake simple + Tope freno retenedor. SF-P70 Fitting set with single softbrake and retaining brake. Garniture SF-P70 avec 1 arrêt et 1 butée avec ressort de retenue.</p> <p>(1 x Softbrake)</p> <p>70kg</p> 		00 72 03		1 juego 1 set 1 jeu	46,98
 <p>Juego SF-P70. x2 Softbrake simple. SF-P70 RA Fitting set with x2 softbrake. Garniture SF-P70 avec x2 arrêt.</p> <p>(2 x Softbrake)</p> <p>70kg</p> 		00 72 01		1 juego 1 set 1 jeu	69,95

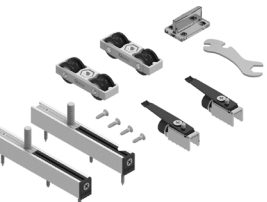

Componentes

Components

JUEGOS SETS JEUX	Finished	Cód.			€/Unit
 <p>Juego de accesorios SF-A90 (pletina 00 60 53) SF-A90 Fitting set 1 door (plate 00 60 53) Garniture SF-A90 1 porte (plaque 00 60 53)</p> <p>90kg</p>      <p>STANDARD MÁX.80kg EXCELLENCE STAR STAR FT RODAMIENTO A BOLAS BALL BEARING ROULEMENT À BILLES</p>		00 81 00		10 juegos 10 sets 10 jeux	26,04
 <p>Juego de accesorios SF-A90 (pletina 00 60 60) SF-A90 Fitting set 1 door (plate 00 60 60) Garniture SF-A90 1 porte (plaque 00 60 60)</p> <p>90kg</p>      <p>STANDARD MÁX.80kg EXCELLENCE STAR STAR FT RODAMIENTO A BOLAS BALL BEARING ROULEMENT À BILLES</p>		00 81 01		10 juegos 10 sets 10 jeux	26,04
 <p>Juego SF-A90. Softbrake simple + Freno retenedor SF-A90 Fitting set with single softbrake and retaining brake Garniture SF-A90 avec 1 arrêt et 1 butée avec ressort de retenue</p> <p>90kg</p>     <p>EXCELLENCE STAR STAR FT RODAMIENTO A BOLAS BALL BEARING ROULEMENT À BILLES</p> <p>(1 x Softbrake)</p>		09 81 91		1 juego 1 set 1 jeu	57,38
 <p>Juego SF-A90. x2 Softbrake simple SF-A90 Fitting set with x2 softbrake Garniture SF-A90 avec x2 arrêt</p> <p>90kg</p>     <p>EXCELLENCE STAR STAR FT RODAMIENTO A BOLAS BALL BEARING ROULEMENT À BILLES</p> <p>(2 x Softbrake)</p>		09 81 90		1 juego 1 set 1 jeu	84,22
OPCIÓN RA RA OPTION OPTION RA					
 <p>Juego de accesorios SF-RA P50 (Rodamiento a fricción) SF-RA P50 Fitting set 1 door (friction bearing) Garniture SF-RA P50 1 porte (roulement à friction)</p> <p>50kg</p>     <p>STANDARD EXCELLENCE STAR STAR FT</p>		00 52 04		1 juego 1 set 1 jeux	31,50
 <p>Juego de accesorios SF-RA60 (Rodamiento a fricción) SF-RA60 Fitting set 1 door (friction bearing) Garniture SF-RA60 1 porte (roulement à friction)</p> <p>60kg</p>     <p>STANDARD EXCELLENCE STAR STAR FT</p>		00 60 04		1 juego 1 set 1 jeux	36,77



Componentes



Components

JUEGOS SETS JEUX	Finished	Cód.			€/Unit
 <p>Juego de accesorios SF-RA P70 SF-RA P70 Fitting set 1 door Garniture SF-RA P70 1 porte</p> <p>70kg</p>  STANDARD MÁX.80kg  EXCELLENCE  STAR  STAR FT  RODAMIENTO A BOLAS BALL BEARING ROULEMENT À BILLES		00 72 11		1 juego 1 set 1 jeux	36,47
 <p>Juego SF-RA P70. Softbrake simple + Freno retenedor. SF-RA P70 Fitting set with single softbrake and retaining brake. Garniture SF-RA P70 avec 1 arrêt et 1 butée avec ressort de retenue.</p> <p>70kg</p>  EXCELLENCE  STAR  STAR FT  RODAMIENTO A BOLAS BALL BEARING ROULEMENT À BILLES		00 72 13		1 juego 1 set 1 jeux	63,77
 <p>Juego SF-RA P70. x2 Softbrake simple. SF-RA P70 Fitting set with x2 softbrake. Garniture SF-RA P70 avec x2 arrêt.</p> <p>70kg</p>  EXCELLENCE  STAR  STAR FT  RODAMIENTO A BOLAS BALL BEARING ROULEMENT À BILLES		00 72 12		1 juego 1 set 1 jeux	89,79
 <p>Juego SF-RA A90. Doble freno retenedor SF-Classic RA A90 Fitting set. Double retaining brake Garniture SF-Classic RA A90. Double frein de retenue</p> <p>90kg</p>  STANDARD MÁX.80kg  EXCELLENCE  STAR  STAR FT  RODAMIENTO A BOLAS BALL BEARING ROULEMENT À BILLES		00 80 04		1 juego 1 set 1 jeu	44,61
 <p>Juego SF-RA A90. Softbrake simple + Freno retenedor SF-RA A90 Fitting set with single softbrake and retaining brake Garniture SF-RA A90 avec 1 arrêt et 1 butée avec ressort de retenue</p> <p>90kg</p>  EXCELLENCE  STAR  STAR FT  RODAMIENTO A BOLAS BALL BEARING ROULEMENT À BILLES		09 81 92		1 juego 1 set 1 jeu	74,30
 <p>Juego SF-RA A90. x2 Softbrake simple SF-RA A90 Fitting set with x2 softbrake Garniture SF-RA A90 avec x2 arrêt</p> <p>90kg</p>  EXCELLENCE  STAR  STAR FT  RODAMIENTO A BOLAS BALL BEARING ROULEMENT À BILLES		09 81 93		1 juego 1 set 1 jeu	103,01

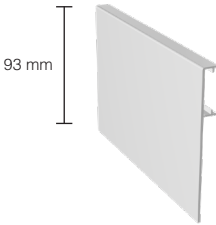

Componentes

Components

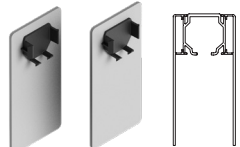
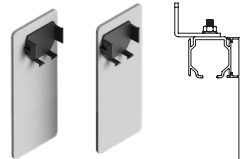
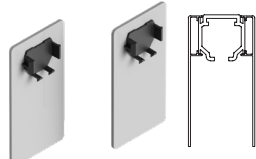
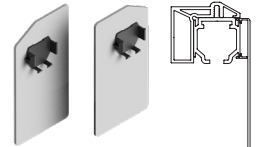
ACCESORIOS ACCESSORIES ACCESSOIRES		Finished	Cód.			€/Unit
 <p>93 mm</p> <p>Tapeta Clip on pelmet cover Bandeau à clipser</p>	<p>S</p>	00 64 23	2 m	2 perfiles 2 profiles 2 profils	26,90	
		00 64 33	3 m		40,35	
		00 64 53	5 m		67,25	
	<p>BL</p>	00 64 25	2 m	2 profiles 2 profils	21,00	
		00 64 45	3 m		31,50	
		00 64 55	5 m		52,50	
 <p>Tapa lateral Standard Standard top track end cap Capuchon final Standard</p>  <p>30x29mm</p>	<p>PPS</p>	00 80 57		25 piezas 25 pieces 25 pièces	1,29	
	 <p>Juego de tapas laterales Standard. Montaje a techo. Tapeta + perfil superior + tapeta Pelmet cover + Standard top track + pelmet cover end cap set Jeu de 2 capuchons finals pour bandeau + rail Standard + bandeau</p>	<p>PPS</p>	00 82 70		1 juego 1 set 1 jeu	16,40
<p>PPB</p>		00 82 71			18,00	
 <p>Juego de tapas laterales Standard. Montaje a pared. Escuadra + perfil superior + tapeta Standard Top track + pelmet cover end cap set Jeu de 2 capuchons finals pour rail + bandeau Standard</p>	<p>PPS</p>	00 82 72		1 juego 1 set 1 jeu	16,40	
	<p>PPB</p>	00 82 73			18,00	
 <p>Juego de tapas laterales Excellence. Montaje a techo. Tapeta + perfil superior + tapeta Pelmet cover + Excellence top track + pelmet cover end cap set Jeu de 2 capuchons finals pour bandeau + rail Excellence + bandeau</p>	<p>PPS</p>	00 82 74		1 juego 1 set 1 jeu	16,40	
	<p>PPB</p>	00 82 75			18,00	
 <p>Juego de tapas laterales Excellence. Montaje a pared. Perfil superior separador + perfil guia superior+ tapeta Full width side fixing profile + Excellence top track + pelmet cover end cap set Jeu de 2 capuchons finals pour profil équerre + rail Excellence + bandeau</p>	<p>PPS</p>	00 82 76		1 juego 1 set 1 jeu	16,40	
	<p>PPB</p>	00 82 77			18,00	



Componentes

Components

ACCESORIOS ACCESSORIES ACCESSOIRES		Finished	Cód.			€/Unit
 <p>Juego de tapas laterales Star. Montaje a techo/pared. Tapeta + perfil superior + tapeta Pelmet cover + Star top track + pelmet cover end cap set Jeu de 2 capuchons finals pour bandeau + rail Star + bandeau</p>  <p>33x23,3mm</p>	PPS	00 52 10			1 juego 1 set	9,60
	PPB	00 52 11			1 jeu	9,60
 <p>Juego de tapas laterales Star. Montaje a pared. Perfil superior separador + perfil guía superior Star + tapeta Full width side fixing profile + Star top track + pelmet cover end cap set Jeu de 2 capuchons finals pour profil équerre + rail Star + bandeau</p>  <p>49x43,3mm</p>	PPS	00 52 15			1 juego 1 set	9,60
	PPB	00 52 16			1 jeu	9,60
 <p>Roldana SF-P50 con tornillo SF-P50 Roller with screw Monture SF-P50 avec vis porteuse</p>		00 52 01			25 piezas 25 pieces 25 pièces	4,95
 <p>Roldana SF-A61 con tornillo (rodamiento a fricción) (pletina 00 60 53 / 00 60 60) SF-A61 Roller with screw (friction bearing) (plate 00 40 59 / 00 60 53 / 00 60 60) Monture SF-A61 avec vis porteuse (roulement à friction) (plaque 00 40 59 / 00 60 53 / 00 60 60)</p>		00 60 52			25 piezas 25 pieces 25 pièces	7,87
 <p>Roldana SF-P70 con tornillo SF-P70 Roller with screw Monture SF-P70 avec vis porteuse</p>  <p>RODAMIENTO A BOLAS BALL BEARING ROULEMENT À BILLES</p>		00 72 04			25 piezas 25 pieces 25 pièces	7,50
 <p>Roldana SF-A90 con tornillo (para pletinas 00 60 53 / 00 60 60) SF-A90 Roller with screw (plate 00 40 59 / 00 60 53 / 00 60 60) Monture SF-A90 (plaque 00 40 59 / 00 60 53 / 00 60 60)</p>  <p>RODAMIENTO A BOLAS BALL BEARING ROULEMENT À BILLES</p>		00 80 52			25 piezas 25 pieces 25 pièces	9,50

PPS

Plástico pintado plata
Plastic painted silver
PVC finition peinture argent





PPB

Plástico pintado negro
Black painted plastic
PVC peinture noir

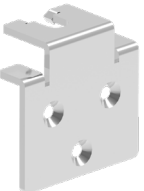

Componentes

Components

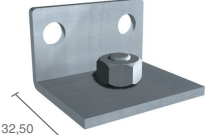
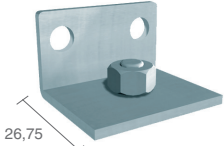
ACCESORIOS ACCESSORIES ACCESSOIRES		Finished	Cód.			€/Unit
	<p>Pletina fijación lateral para paneles de poco grueso Lateral fixing plate for panels of small thickness Panneaux latéraux de fixation pletina peu épaisse</p>		00 40 59		25 piezas 25 pieces 25 pièces	4,37
	<p>Pletina regulación sobrepuesta Face fixed adjustable mounting plate Plaque de réglage à visser</p>		00 60 53		25 piezas 25 pieces 25 pièces	1,21
	<p>Pletina regulación encastrada Recessed adjustable mounting plate Plaque de réglage à encastrer</p>		00 60 60		25 piezas 25 pieces 25 pièces	1,21
 32,50	<p>Soporte pared escuadra Top track side fixing bracket Support équerre pour fixation murale</p>		00 60 54 ¹		25 piezas 25 pieces 25 pièces	1,08
 26,75	<p>Soporte pared escuadra estándar Top track side fixing bracket Équerre de fixation murale</p>		00 66 58 ¹		25 piezas 25 pieces 25 pièces	1,10

¹ Para las familias que incorporen soporte pared con perfilera de 2 m, 3 m, 5 m o 6 m, aplicar uno por cada taladro | *For sets that incorporate a wall support with 2m, 3m, 5m or 6m profiling, apply one for each drill hole | *Pour les familles intégrant un support mural avec huisserie de 2m, 3m, 5m ou 6m, appliquer un support pour chaque trou percé.

2 m 10 soportes pared | supports wall | supports muraux
3 m 15 soportes pared | supports wall | supports muraux
5 m 25 soportes pared | supports wall | supports muraux



Componentes

Components

ACCESORIOS ACCESSORIES ACCESSOIRES		Finished	Cód.			€/Unit
	<p>Soporte pared escuadra con regulación (reversible) Adjustable wall fixing bracket Support équerre pour fixation murale réglable</p>		00 60 59		25 piezas 25 pieces 25 pièces	1,98
	<p>Soporte tapeta universal Clip on bracket for timber pelmet covers (universal) Clip de fixation pour bandeau en bois (universel)</p>		00 60 56		10 piezas 10 pieces 10 pièces	4,23
	<p>Tope freno SF-A60 / SF-A90 SF-A60 / SF-A90 Brake stopper Butée arrêt SF-A60 / SF-A90</p>		00 60 55		25 piezas 25 pieces 25 pièces	1,85
	<p>Freno retenedor SF-A60 / SF-A90 SF-A60 / SF-A90 Retaining track stopper Butée avec ressort de retenue SF-A60 / SF-A90</p>		00 60 57		25 piezas 25 pieces 25 pièces	3,17
	<p>Freno retenedor SF-P70 SF-P70 retaining brake frein de retenu Roller SF-P70</p>		00 72 19		25 piezas 25 pieces 25 pièces	1,50
	<p>Guiador inferior plástico Bottom guide Guide inférieur</p>		00 35 54		25 piezas 25 pieces 25 pièces	0,53

Essential Timber

SF-P50 | SF-A60 | SF-P70 | SF-A90 |

SF-RA P50 | SF-RA A60 | SF-RA P70 | SF-RA A90



Polígono Industrial de Foradada / 08580
St. Quirze de Besora / Barcelona / Spain
T +34 93 852 92 23
F +34 93 852 91 59
saheco@saheco.com

Export contact details
T +34 93 852 96 15
F +34 93 855 13 42
export@saheco.com
saheco.com