

_02.6
LAY-ON BACK SECTION
CANALE IN APPOGGIO

02.1 Kitchen accessories | *Accessori per cucina*

02.2 Materials | *Materiali*

02.3 BelNet 472 | *BelNet 472*

02.4 Cuibus | *Cuibus*

02.5 Low depth back section | *Canale a incasso*

02.6 Lay-on back section | *Canale in appoggio*

02.7 Lay-on double back section | *Alzata in appoggio*

02.8 Alessi accessories | *Accessori Alessi*

02.9 BelNet finishings | *Finiture BelNet*



Designed to bring order on the kitchen counter, the Lay-on Back Section stays where you place it, but can also be moved where you need it, thanks to the practical reusable fastener used to fix it to the counter top. Coming in four standard measures, and three standard colors the Lay-On Back Section can satisfy every cook's need for practicality and orderliness. Equipped with our BelNet 472 inserts, extremely versatile and practical the Lay-On Back Section is the perfect tool to accessorize the kitchen with tidiness and glamour.

Disegnato per portare ordine sul top della cucina, il canale attrezzato in appoggio si può posizionare dove più si preferisce proprio perché è solo appoggiato sul top della cucina e fissato grazie ad uno speciale velcro che dà la possibilità di rimuoverlo ogni qualvolta ce ne sia il bisogno.

Proprio questa caratteristica di fissaggio, che evita lavorazioni sul top della cucina, lo rende particolarmente semplice da installare anche su una cucina già esistente. Equipaggiato con tutti gli accessori della linea BelNet 472, questo canale attrezzato è estremamente pratico e funzionale, portando carattere anche alle cucine più semplici.

LAY-ON BACK SECTION CANALE IN APPOGGIO

Thanks to the reusable fastener at the bottom, the Lay-On Back Section stays where you put it, but can be moved when and where you need it, without requiring any milling on the kitchen top.

Il fissaggio sul top avviene grazie ad uno speciale velcro che dà la possibilità di rimuoverlo ogni qualvolta ce ne sia il bisogno. Proprio questa caratteristica di fissaggio, che evita lavorazioni sul top della cucina, lo rende particolarmente semplice da installare anche su una cucina già esistente.

EASY TO INSTALL ON THE KITCHEN TOP FACILE DA INSTALLARE SUL TOP DELLA CUCINA

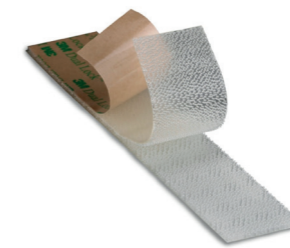

CUSTOMIZATION AVAILABLE POSSIBILITÀ DI PERSONALIZZAZIONE

The Lay-On Back Section can be produced in customized measures, and it can be supplied also without bottom panel.

Il canale in appoggio può essere prodotto in misure personalizzate, e può essere fornito anche senza fondo.

LAY-ON BACK SECTION - MODULE 900
CANALE IN APPOGGIO - MODULO 900

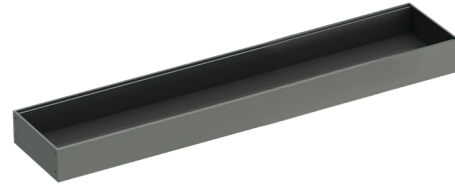

ITEM	FINISHING	MODULE (mm)	MEASURE (mm)
BN524.001.003	Brown Metal Grey <i>Brown Metal Grey</i>	900	780 x 166 x 60
BN524.001.004	Silver Lead <i>Piombo</i>	900	780 x 166 x 60
BN524.001.017	Black <i>Nero</i>	900	780 x 166 x 60

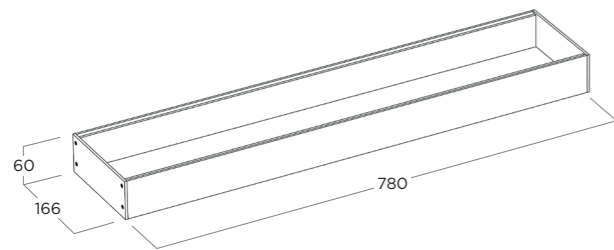

HOW TO EQUIP THE LAY-ON BACK SECTION | COME ACCESSORIARE IL CANALE IN APPOGGIO

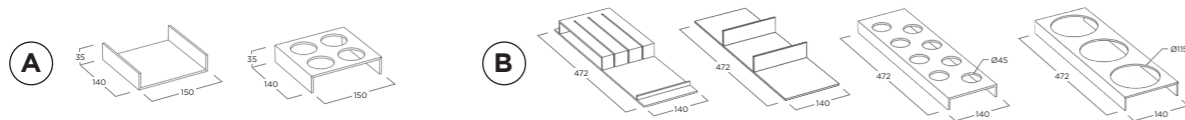

FINISHINGS
FINITURE



Silver Lead Aluminium
Alluminio Piombo

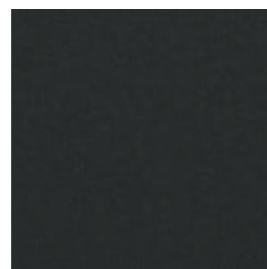

Brown Metal Grey Aluminium
Alluminio Brown Metal Grey



Black Aluminium
Alluminio Nero

LAY-ON BACK SECTION - MODULE 1200
CANALE IN APPOGGIO - MODULO 1200

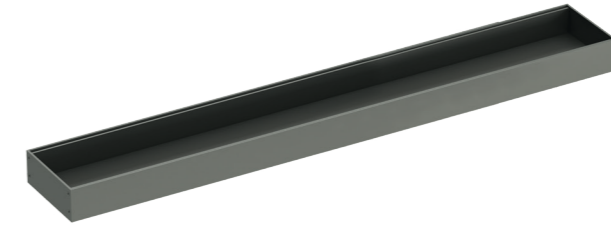

ITEM	FINISHING	MODULE (mm)	MEASURE (mm)
BN524.001.007	Brown Metal Grey <i>Brown Metal Grey</i>	1200	1103 x 166 x 60
BN524.001.008	Silver Lead <i>Piombo</i>	1200	1103 x 166 x 60
BN524.001.018	Black <i>Nero</i>	1200	1103 x 166 x 60

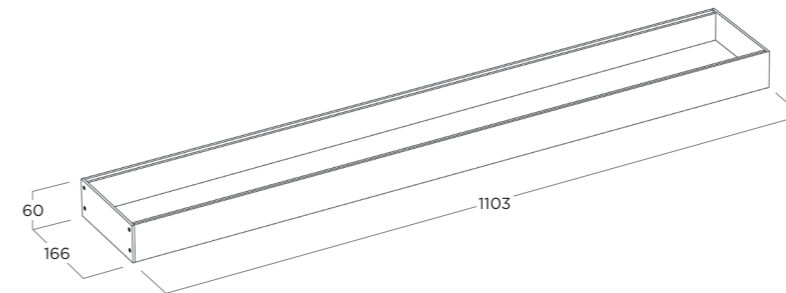

HOW TO EQUIP THE LAY-ON BACK SECTION | COME ACCESSORIARE IL CANALE IN APPOGGIO

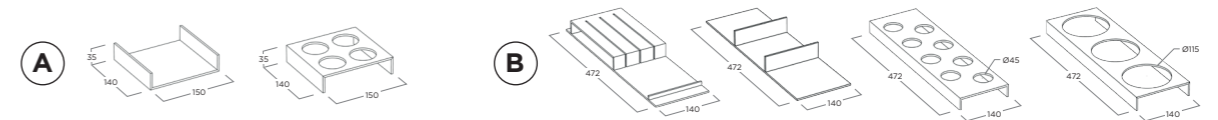
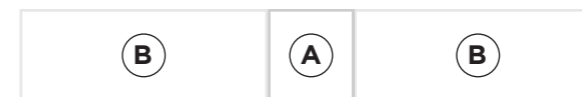

FINISHINGS
FINITURE



Silver Lead Aluminium
Alluminio Piombo

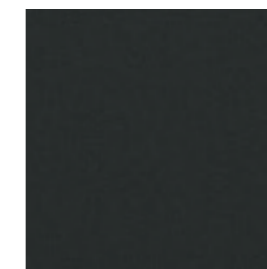

Brown Metal Grey Aluminium
Alluminio Brown Metal Grey



Black Aluminium
Alluminio Nero

LAY-ON BACK SECTION - MODULE 1500
CANALE IN APPOGGIO - MODULO 1500

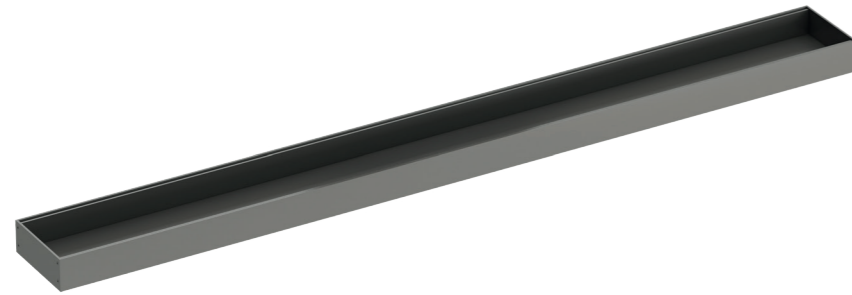

ITEM	FINISHING	MODULE (mm)	MEASURE (mm)
BN524.001.011	Brown Metal Grey <i>Brown Metal Grey</i>	1500	1403 x 166 x 60
BN524.001.012	Silver Lead <i>Piombo</i>	1500	1403 x 166 x 60
BN524.001.019	Black <i>Nero</i>	1500	1403 x 166 x 60

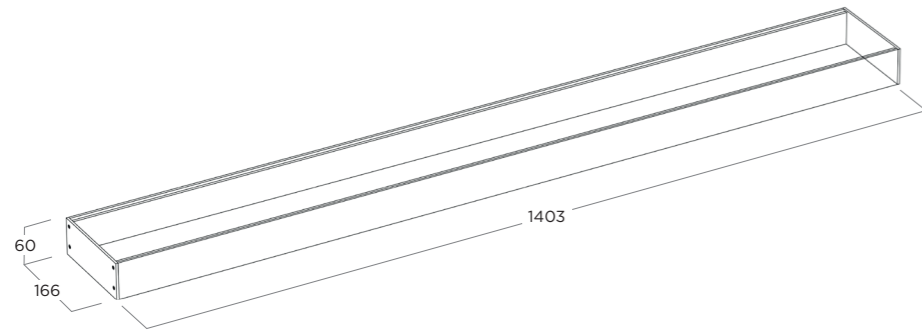

HOW TO EQUIP THE LAY-ON BACK SECTION | COME ACCESSORIARE IL CANALE IN APPOGGIO

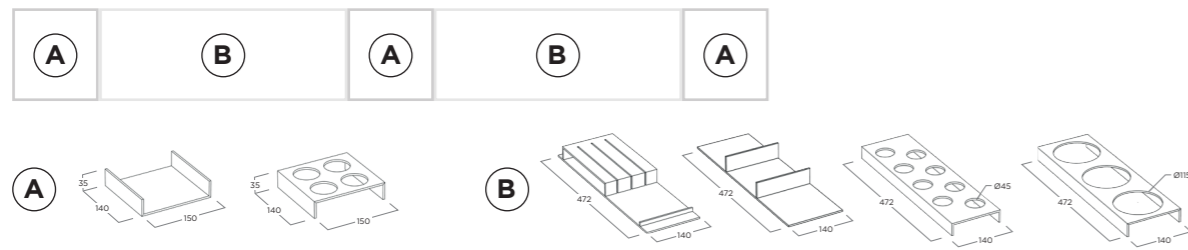

FINISHINGS
FINITURE

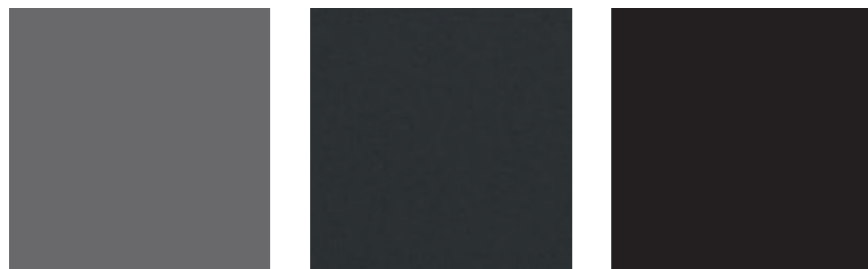

Silver Lead Aluminium
Alluminio Piombo

Brown Metal Grey Aluminium
Alluminio Brown Metal Grey

Black Aluminium
Alluminio Nero

LAY-ON BACK SECTION - MODULE 1800
CANALE IN APPOGGIO - MODULO 1800



ITEM	FINISHING	MODULE (mm)	MEASURE (mm)
BN524.001.015	Brown Metal Grey <i>Brown Metal Grey</i>	1800	1726 x 166 x 60
BN524.001.016	Silver Lead <i>Piombo</i>	1800	1726 x 166 x 60
BN524.001.020	Black <i>Nero</i>	1800	1726 x 166 x 60

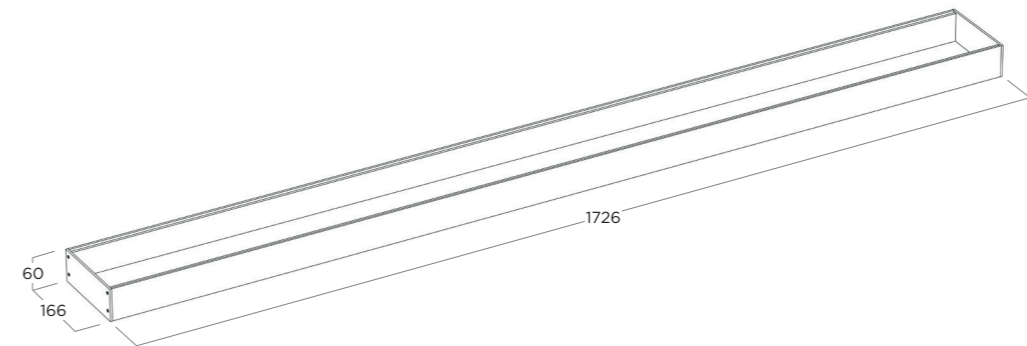

HOW TO EQUIP THE LAY-ON BACK SECTION | COME ACCESSORIARE IL CANALE IN APPOGGIO

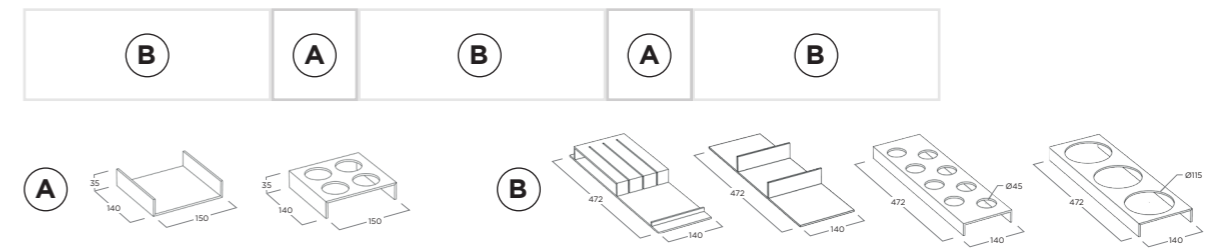

FINISHINGS
FINITURE

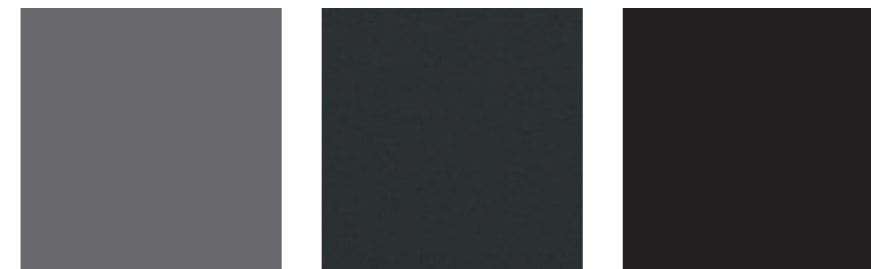

Silver Lead Aluminium
Alluminio Piombo

Brown Metal Grey Aluminium
Alluminio Brown Metal Grey

Black Aluminium
Alluminio Nero

_02.7
**LAY-ON DOUBLE
 BACK SECTION**
ALZATA IN APPOGGIO

02.1 Kitchen accessories | *Accessori per cucina*

02.2 Materials | *Materiali*

02.3 BelNet 472 | *BelNet 472*

02.4 Cuibus | *Cuibus*

02.5 Low depth back section | *Canale a incasso*

02.6 Lay-on back section | *Canale in appoggio*

02.7 Lay-on double back section | *Alzata in appoggio*

02.8 Alessi accessories | *Accessori Alessi*

02.9 BelNet finishings | *Finiture BelNet*



Evolution of the Lay-on Back Section, the Lay-On Double Back Section finds more storage space on the kitchen counter by expanding vertically. Using the reusable fastener to be kept in place, but moved when needed, the Lay-On Double brings dynamism to the cooking area. Coming in three standard measures, and three standard colors this back section can satisfy every cook's need for tidiness and functionality. Equipped with our BelNet 472 inserts, extremely versatile and practical the Lay-On Double Back Section is the perfect tool to accessorize the kitchen with order and style.

L'alzata in appoggio non è altro che l'evoluzione del canale in appoggio sviluppato in altezza su due livelli di contenimento. Anche in questa situazione il fissaggio sul top avviene tramite lo speciale velcro che consente di poter rimuovere l'alzata in ogni momento, ma al contempo dona una stabilità perfetta quando fissata, senza necessità di lavorazioni sul top della cucina. Disponibile in tre lunghezze standard, si adatta perfettamente a tutti i tipi di cucina, sia nelle cucine a muro che nelle isole centro stanza. Equipaggiato con tutti gli accessori della linea BelNet 472, questo canale attrezzato è estremamente pratico e funzionale, portando carattere anche alle cucine più semplici.

LAY-ON DOUBLE BACK SECTION ALZATA IN APPOGGIO

Thanks to the reusable fastener at the bottom, the Lay-On Double Back Section stays where you put it, but can be moved when and where you need it, without requiring any milling on the kitchen top.

Il fissaggio sul top avviene grazie ad uno speciale velcro che dà la possibilità di rimuoverlo ogni qualvolta ce ne sia il bisogno. Proprio questa caratteristica di fissaggio, che evita lavorazioni sul top della cucina, lo rende particolarmente semplice da installare anche su una cucina già esistente.

EASY TO INSTALL ON THE KITCHEN TOP FACILE DA INSTALLARE SUL TOP DELLA CUCINA



CUSTOMIZATION AVAILABLE POSSIBILITÀ DI PERSONALIZZAZIONE

The Lay-On Double Back Section can be produced in customized measures.

L'alzata in appoggio può essere prodotta in misure personalizzate.

LAY-ON DOUBLE BACK SECTION - MODULE 900 ALZATA IN APPOGGIO - MODULO 900



ITEM	FINISHING	MODULE (mm)	MEASURE (mm)
BN525.001.010	Brown Metal Grey Brown Metal Grey	900	780 x 166 x 310
BN525.001.001	Silver Lead Piombo	900	780 x 166 x 310
BN525.001.013	Black Nero	900	780 x 166 x 310

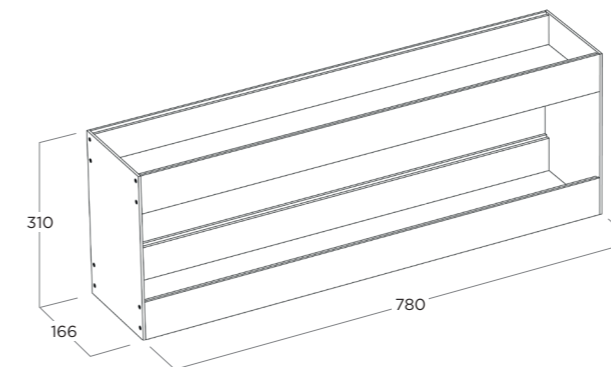

HOW TO EQUIP THE LAY-ON DOUBLE BACK SECTION | COME ACCESSORIARE L'ALZATA IN APPOGGIO

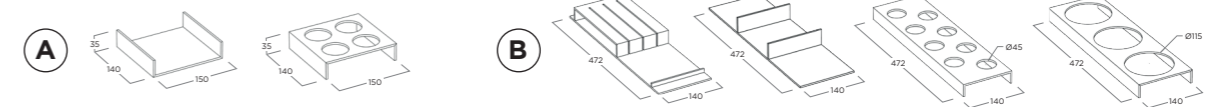

FINISHINGS FINITURE



Silver Lead Aluminium
Alluminio Piombo

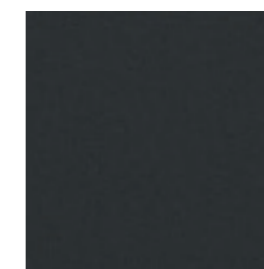

Brown Metal Grey Aluminium
Alluminio Brown Metal Grey



Black Aluminium
Alluminio Nero

LAY-ON DOUBLE BACK SECTION - MODULE 1200
ALZATA IN APPOGGIO - MODULO 1200

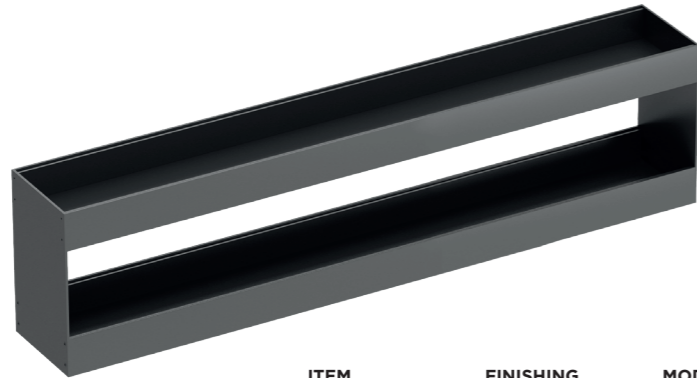

ITEM	FINISHING	MODULE (mm)	MEASURE (mm)
BN525.001.011	Brown Metal Grey <i>Brown Metal Grey</i>	1200	1103 x 166 x 310
BN525.001.002	Silver Lead <i>Piombo</i>	1200	1103 x 166 x 310
BN525.001.014	Black <i>Nero</i>	1200	1103 x 166 x 310

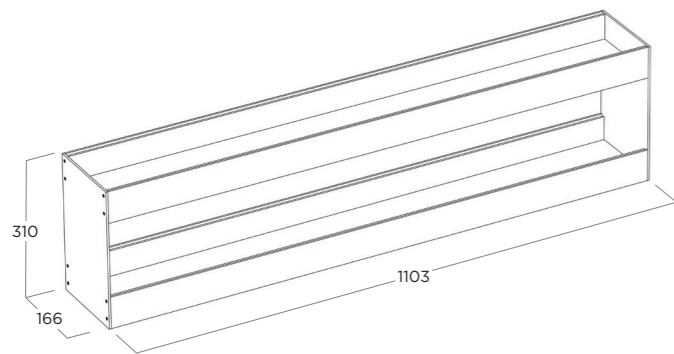

HOW TO EQUIP THE LAY-ON DOUBLE BACK SECTION | COME ACCESSORIARE L'ALZATA IN APPOGGIO

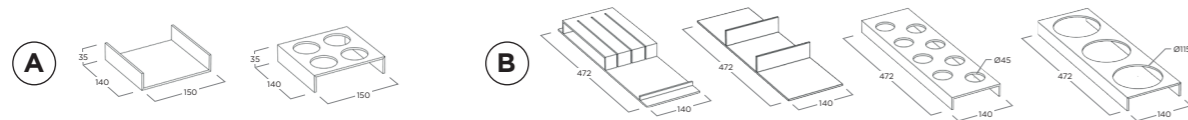
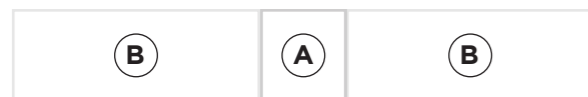

FINISHINGS
FINITURE



Silver Lead Aluminium
Alluminio Piombo

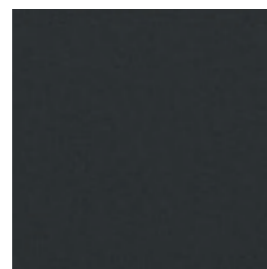

Brown Metal Grey Aluminium
Alluminio Brown Metal Grey



Black Aluminium
Alluminio Nero

LAY-ON DOUBLE BACK SECTION - MODULE 1500
ALZATA IN APPOGGIO - MODULO 1500

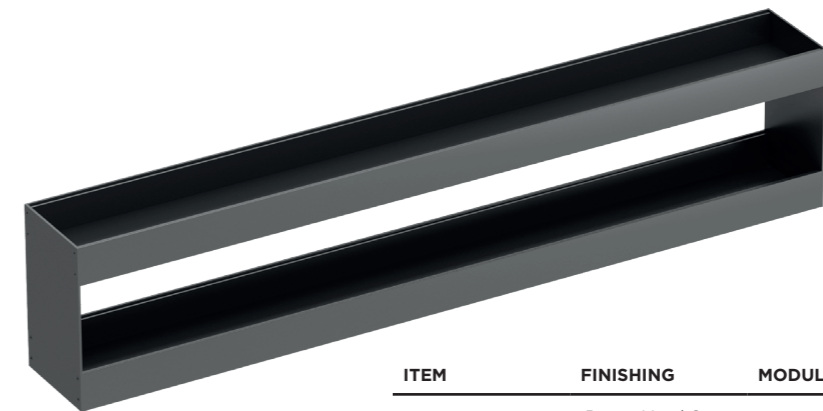

ITEM	FINISHING	MODULE (mm)	MEASURE (mm)
BN525.001.012	Brown Metal Grey <i>Brown Metal Grey</i>	1500	1403 x 166 x 310
BN525.001.003	Silver Lead <i>Piombo</i>	1500	1403 x 166 x 310
BN525.001.015	Black <i>Nero</i>	1500	1403 x 166 x 310

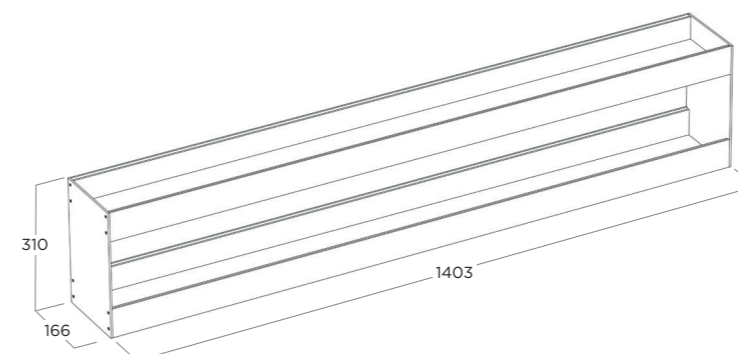

HOW TO EQUIP THE LAY-ON DOUBLE BACK SECTION | COME ACCESSORIARE L'ALZATA IN APPOGGIO

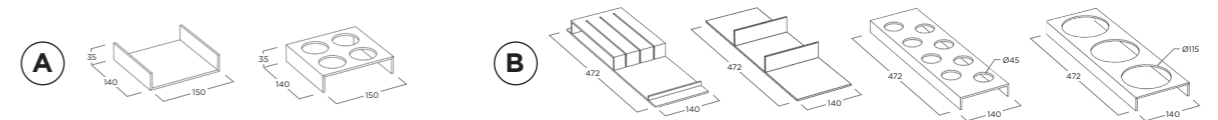
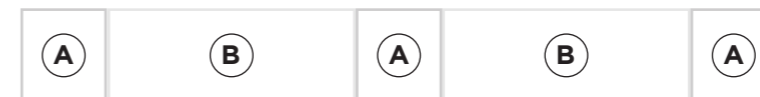

FINISHINGS
FINITURE



Silver Lead Aluminium
Alluminio Piombo

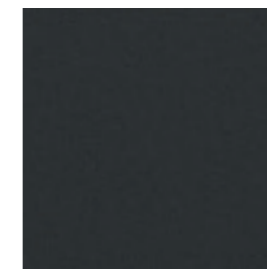

Brown Metal Grey Aluminium
Alluminio Brown Metal Grey



Black Aluminium
Alluminio Nero

ACCESSORIES
ACCESSORI

KNIVES RACK
PORTA COLTELLI



ITEM	FINISHING
BN521.003.001	Canaletto Walnut Noce Canaletto

KNIVES RACK
PORTA COLTELLI

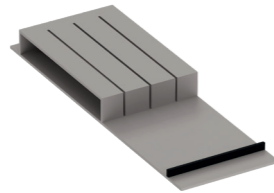

ITEM	FINISHING
BN521.003.002	Corda Corda

KNIVES RACK
PORTA COLTELLI

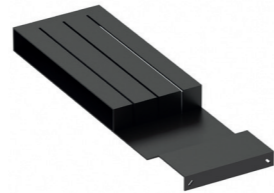

ITEM	FINISHING
BN521.003.004	Brown Metal Grey Brown Metal Grey

KNIVES RACK
PORTA COLTELLI

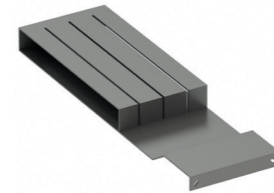

ITEM	FINISHING
BN521.003.005	Silver Lead Piombo

KNIVES RACK
PORTA COLTELLI

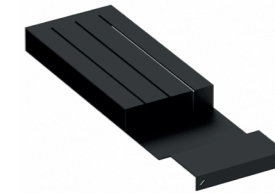

ITEM	FINISHING
BN521.003.006	Black Nero

TECHNICAL DETAILS
DISEGNO TECNICO

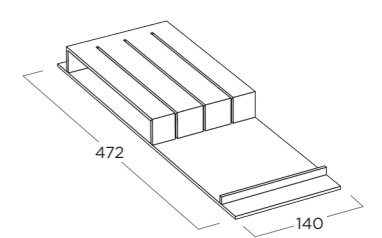

DIVIDER
PORTA OGGETTI



ITEM	FINISHING
BN521.006.001	Canaletto Walnut Noce Canaletto

DIVIDER
PORTA OGGETTI



ITEM	FINISHING
BN521.006.002	Corda Corda

DIVIDER
PORTA OGGETTI

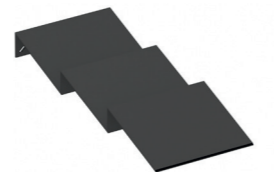

ITEM	FINISHING
BN521.006.004	Brown Metal Grey Brown Metal Grey

DIVIDER
PORTA OGGETTI

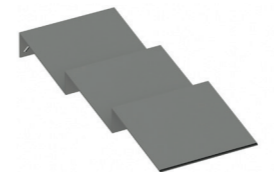

ITEM	FINISHING
BN521.006.005	Silver Lead Piombo

DIVIDER
PORTA OGGETTI

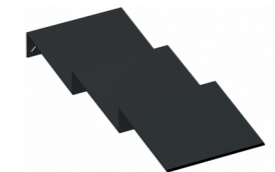

ITEM	FINISHING
BN521.006.006	Black Nero

TECHNICAL DETAILS
DISEGNO TECNICO

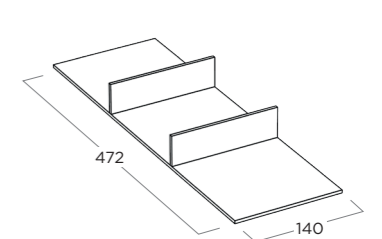

SPICE JARS HOLDER
PORTA SPEZIE



ITEM	FINISHING
BN521.004.001	Canaletto Walnut Noce Canaletto

SPICE JARS HOLDER
PORTA SPEZIE

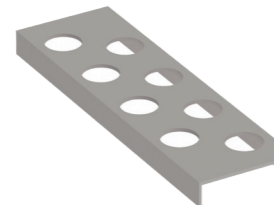

ITEM	FINISHING
BN521.004.002	Corda Corda

SPICE JARS HOLDER
PORTA SPEZIE

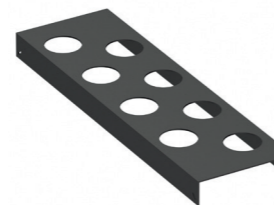

ITEM	FINISHING
BN521.002.002	Brown Metal Grey Brown Metal Grey

SPICE JARS HOLDER
PORTA SPEZIE

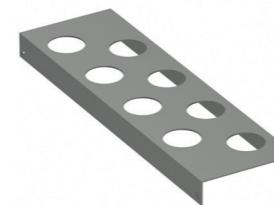

ITEM	FINISHING
BN521.002.003	Silver Lead Piombo

SPICE JARS HOLDER
PORTA SPEZIE

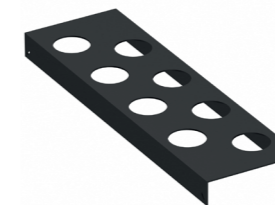

ITEM	FINISHING
BN521.002.004	Black Nero

TECHNICAL DETAILS
DISEGNO TECNICO

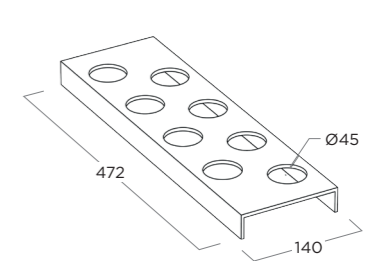

JARS HOLDER
PORTA BARATTOLI



ITEM	FINISHING
BN521.001.002	Canaletto Walnut Noce Canaletto

JARS HOLDER
PORTA BARATTOLI

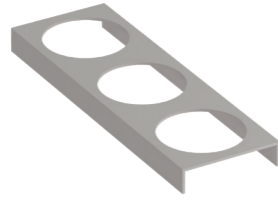

ITEM	FINISHING
BN521.001.003	Corda Corda

JARS HOLDER
PORTA BARATTOLI



ITEM	FINISHING
BN521.001.005	Brown Metal Grey Brown Metal Grey

JARS HOLDER
PORTA BARATTOLI

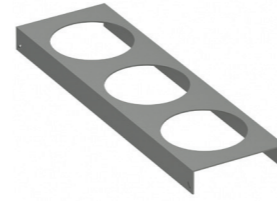

ITEM	FINISHING
BN521.001.006	Silver Lead Piombo

JARS HOLDER
PORTA BARATTOLI



ITEM	FINISHING
BN521.001.007	Black Nero

TECHNICAL DETAILS
DISEGNO TECNICO

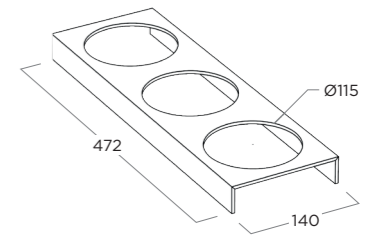

SPICE RACK
PORTA SPEZIE



ITEM	FINISHING
BN508.002.003	Canaletto Walnut Noce Canaletto

SPICE RACK
PORTA SPEZIE

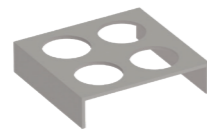

ITEM	FINISHING
BN508.002.002	Corda Corda

SPICE RACK
PORTA SPEZIE

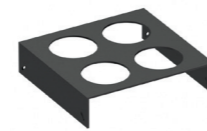

ITEM	FINISHING
BN508.002.005	Brown Metal Grey Brown Metal Grey

SPICE RACK
PORTA SPEZIE

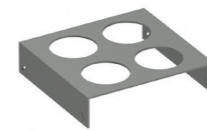

ITEM	FINISHING
BN508.002.006	Silver Lead Piombo

SPICE RACK
PORTA SPEZIE

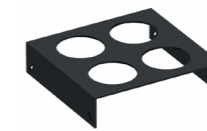

ITEM	FINISHING
BN508.002.007	Black Nero

TECHNICAL DETAILS
DISEGNO TECNICO

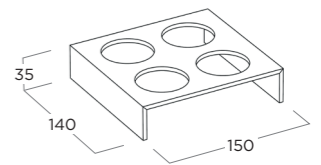

U TRAY
VASSOIO



ITEM	FINISHING
BN508.001.003	Canaletto Walnut Noce Canaletto

U TRAY
VASSOIO

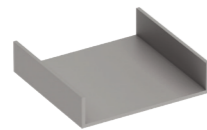

ITEM	FINISHING
BN508.001.002	Corda Corda

U TRAY
VASSOIO



ITEM	FINISHING
BN508.001.005	Brown Metal Grey Brown Metal Grey

U TRAY
VASSOIO

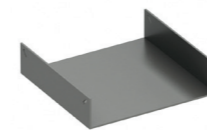

ITEM	FINISHING
BN508.001.006	Silver Lead Piombo

U TRAY
VASSOIO



ITEM	FINISHING
BN508.001.007	Black Nero

TECHNICAL DETAILS
DISEGNO TECNICO

