

opk SUBMARINE 9 W InSide



max. 2400mm



max. 1500mm



W ≥ 16mm



± 2mm



Möbel Systeme
Furniture systems

opk Submarine 9 W InSide



Technische Zeichnung

Technical drawing

Keine Dämpfung
No damping

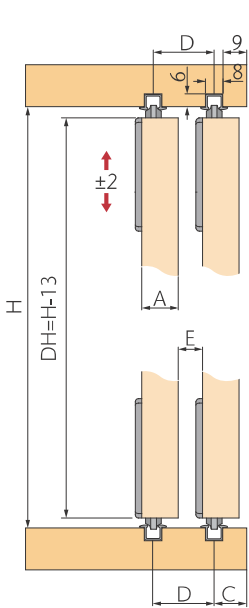

	A (16mm)	A (18mm)	A (19mm)
C	13mm	13mm	13mm
D	22mm	24mm	25mm
E	6mm	6mm	6mm

Beidseitige Dämpfung
Both sides damping

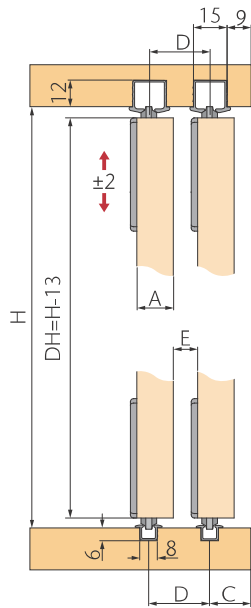

	A (16mm)	A (18mm)	A (19mm)
C	16.5mm	16.5mm	16.5mm
D	22mm	24mm	25mm
E	6mm	6mm	6mm

Beidseitige Dämpfung
Both sides damping

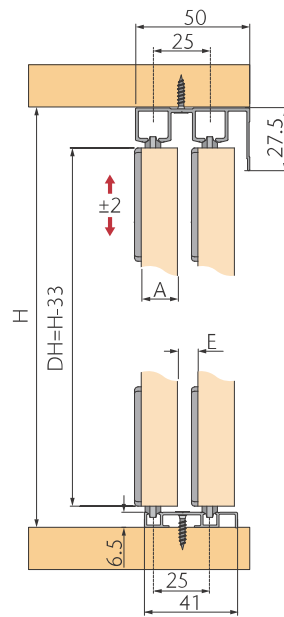

	A (16mm)	A (18mm)	A (19mm)
E	9mm	7mm	6mm

Beidseitige Dämpfung
Both sides damping

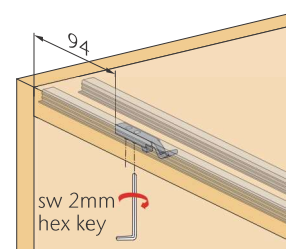
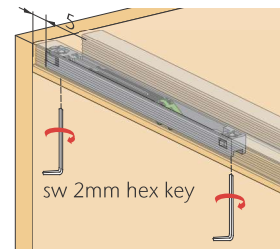
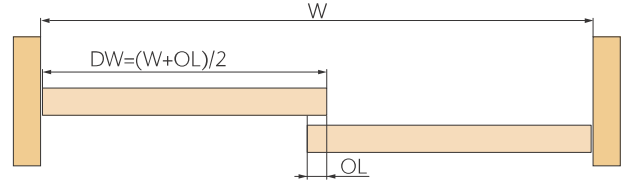
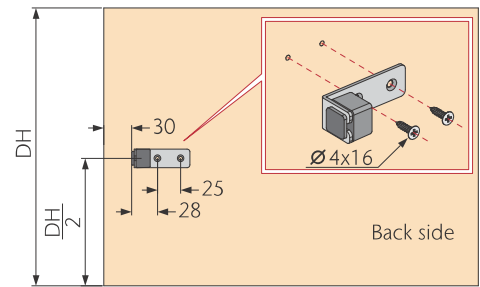
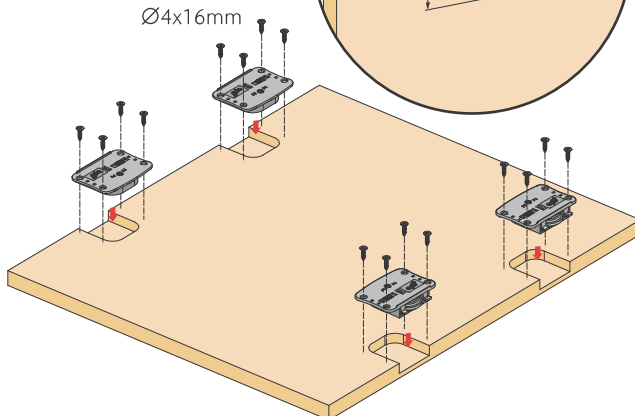
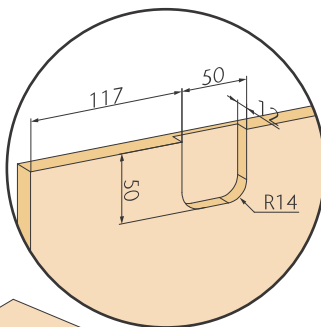
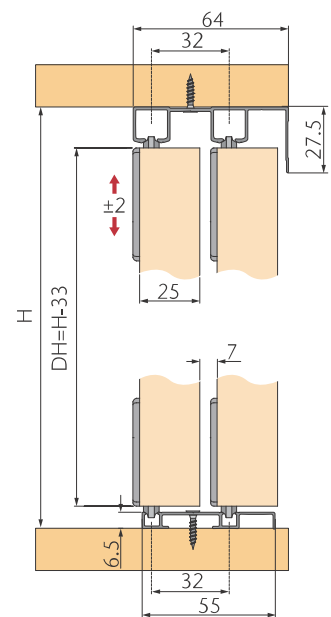

opk Submarine 9 W InSide



Art.-Nr./No.

		≤30	300~ 1500	≤2400	01-491-101-100
		≤15	500~ 1500	≤2400	01-491-102-115
		≤30			01-491-102-130

Konfiguration für 1 Tür

Configuration for 1 door







Laufwerk/Führung <i>Running/Guiding part</i>		4	4
Dämpfer <i>Damper</i>		0	2
Stopper <i>Stopper</i>		2	0
ST4.2x16 Senkkopfschraube mit Kreuzschlitz <i>ST4.2x16 Cross recess countersunk head self-drilling screw</i>		16	16
sw 2mm Innensechskant <i>sw 2mm hex key</i>		1	1

opk Submarine 9 W InSide

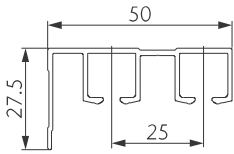
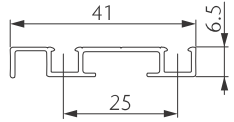
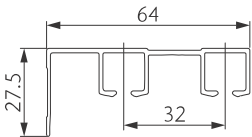
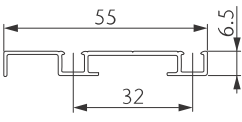

Schienen, Zubehör Tracks, Accessories

Produktbeschreibung Description		Material Material	Farbe Finish	Länge Length (mm)	Art.-Nr./No.
For variable door thickness	Führungsschiene Guiding track 	Aluminium eloxiert Anodized aluminium	Silber Silver	2500	01-497-250-125
				3500	01-497-250-135
	Laufschiene Running track 	Aluminium eloxiert Anodized aluminium	Silber Silver	2500	01-496-250-125
					3500
For 16-19mm door thickness	Führungsschiene, doppelt Guiding track double 	Aluminium eloxiert Anodized aluminium	Silber Silver	2500	01-497-250-425
				3500	01-497-250-435
	Laufschiene, doppelt Running track double 	Aluminium eloxiert Anodized aluminium	Silber Silver	2500	01-496-250-425
					3500
For 25mm door thickness	Führungsschiene, doppelt Guiding track double 	Aluminium eloxiert Anodized aluminium	Silber Silver	2500	01-497-250-525
				3500	01-497-250-535
	Laufschiene, doppelt Running track double 	Aluminium eloxiert Anodized aluminium	Silber Silver	2500	01-496-250-525
					3500
Türmitnehmer Door follower 		Für zwei Türen For two doors	Titan Titan	pc	01-104-908-000