

MESINOR

mesas y sillas

**MESINOR**

**TABURETES  
BARRAS**

[mesinor.com](http://mesinor.com)

MESAS Y SILLAS DEL NORTE, S.L

26250 Santo Domingo de la Calzada

LA RIOJA. ESPAÑA

T.+34 941 340 043

[info@mesinor.com](mailto:info@mesinor.com)

TABURETES Y BARRAS

## Nuestros 4 principales pilares

### TRADICIÓN

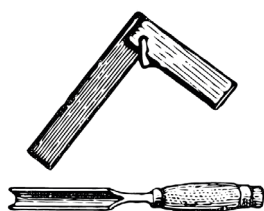

Mesas y Sillas del Norte, **MESINOR** nace desde la experiencia. Aunamos tradición y tecnología. Una empresa familiar ubicada en un territorio amable donde el buen hacer y la conservación de las tradiciones forma parte de su ADN.

Avanzamos hacia un futuro próspero con unas bases firmes, apostando por lo local, exportamos **TALENTO, CALIDAD** y **SERVICIO**, siendo nuestra marca de identidad..

### PRODUCTO



Los productos **MESINOR** se hacen con detalle y a la carta, optimizando procesos para conseguir un producto competitivo que va a satisfacer tus expectativas.

Contamos con proveedores cercanos y primeras marcas para conseguir el mejor de los resultados para tus proyectos.

**MESINOR** es símbolo de **CALIDAD**.

### CLIENTE EN EL CENTRO



Nos encargamos de todo, para **MESINOR**, nuestro cliente es nuestro valor más importante.

Trabajamos con detalle porque **fabricamos a tu medida**, sólo tienes que imaginar porque nosotros lo haremos.

Y con el mejor servicio porque tú eres lo más importante.

### COMPROMISO SOSTENIBLE



Desde **MESINOR** tenemos marcados nuestros objetivos para el compromiso sostenible.

Estamos comprometidos con impulsar el **Crecimiento Económico** y la **Innovación**, alcanzar la excelencia en **Seguridad** y **Salud Laboral**, reducir nuestra **Huella Medioambiental**, promover la **Economía Circular**, ser un buen vecino y asegurar el cumplimiento de las **Normativas** y crear **Transparencia**.

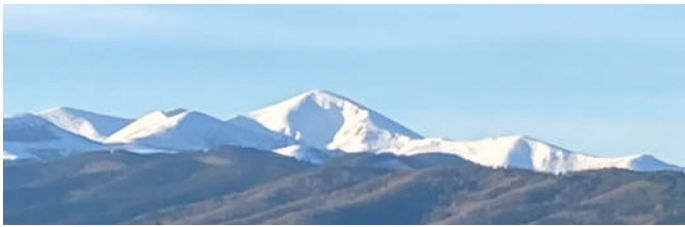

mesas y sillas

# MESINOR



FACToR  
HUMANO



FABRICADO  
EN  
LA RIOJA

PRODUCTO  
NACIONAL



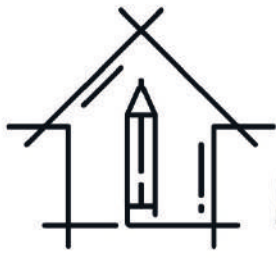

# MESINOR A TU MEDIDA



## PERSONALIZACIÓN PERSONNALISATION

Si tienes un proyecto y buscas un producto **PERSONALIZADO**, cuenta con el servicio de **ASESORAMIENTO MESINOR A TU MEDIDA**.

## PRIMERAS MARCAS PREMIÈRES MARQUES

**MESINOR** somos fabricantes de **MESAS Y SILLAS** y nuestro trabajo es garantía de buenos acabados.

Trabajamos con las **PRIMERAS MARCAS DEL SECTOR**.

Si buscas **ALGO DISTINTO** cuenta con el servicio de **ASESORAMIENTO MESINOR A TU MEDIDA**.

## TRABAJAMOS A TU MEDIDA NOUS TRAVAILLONS SUR MESURE

Si se puede hacer lo **HACEMOS**, todas las medidas disponibles y muestrarios de **COLECCIONES COMPLETAS**.

Si buscas algo **SÓLO PARA TI** cuenta con el servicio de **ASESORAMIENTO MESINOR A TU MEDIDA**.



# Colección Taburetes y Barras

## ¿Te falta algo en tu cocina para conseguir un toque de originalidad?

Gracias a su diseño sencillo y ligero, el **taburete** es uno de los muebles más versátiles que existen.

Aunque su función es meramente práctica, los **taburetes** tienen mucha fuerza decorativa, especialmente en la cocina. Sirven para llevar el color, dotar un toque natural o crear un punto de contraste con el resto de la decoración.

En cocinas abiertas, con barra u office los **taburetes** altos son un esencial, aún más si son regulables los podrás usar de muchas formas: el **taburete** es práctico, versátil y muy decorativo.

**Mesinor** te ofrece varias opciones de **MESA BARRA**. Personalizables y a medida de tus proyectos.

Para una solución de espacio mínimo pero de grandes prestaciones tenemos la **Mesa Fold**, no ocupa nada y es realmente útil.

En **Mesinor** podrás encontrar los **taburetes y barras** que mejor se adapten a tus necesidades y presupuesto.

Y con el mejor **servicio y atención**.

**MESINOR.com**



mesas y sillas

FAMILIA HUGO

<p>HUGO, 65 ó 75</p> <p>12 15</p>	<p>NELL</p> <p>12 15</p>	<p>MIQUE</p> <p>12 15</p>	<p>QUELA</p> <p>12 15</p>	<p>TELLUS</p> <p>12 15</p>
<p>MILLÁN Haya o Roble</p> <p>13 15</p>	<p>EROS</p> <p>13 15</p>	<p>FON</p> <p>13 15</p>		

FAMILIA ARANA

<p>ARANA</p> <p>18 21</p>	<p>IBAR, 65 ó 75</p> <p>18 21</p>	<p>HICA</p> <p>18 21</p>	<p>ANDRA Haya o Roble</p> <p>19 21</p>	<p>MINAYA</p> <p>19 21</p>
<p>ANAYA</p> <p>19 21</p>				

FAMILIA CRUZ

<p>CRUZ, 65 ó 75</p> <p>25 27</p>	<p>CROSS</p> <p>25 27</p>	<p>CROCE Haya o Roble</p> <p>25 27</p>
-----------------------------------	---------------------------	--

NUEVO  
CATÁLOGO TARIFA

FAMILIA GEA

PAG. 28\_33

GEA, 65 ó 75



30 33

TALES

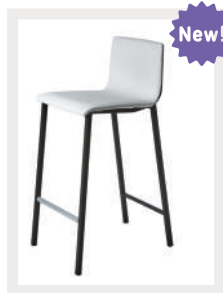

30 33

ZENÓN

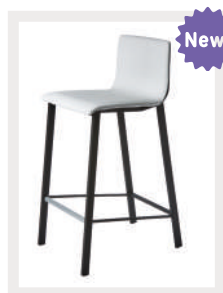

30 33

SAMOS

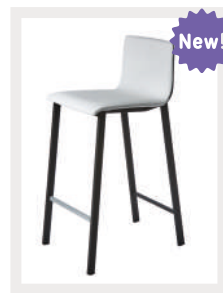

30 33

HADES



30 33

ZEUS Haya o Roble

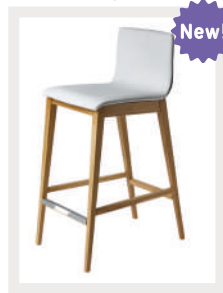

31 33

HERMES

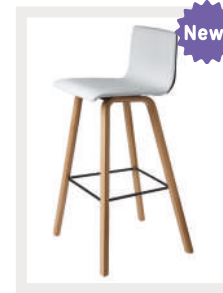

31 33

FAMILIA MENDIA

PAG. 34\_39

MENDIA



36 39

ZURIA, 65 ó 75



36 39

BELASA

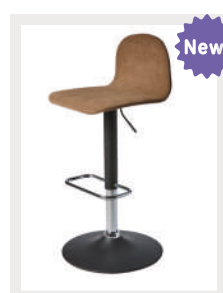

36 39

GORA



36 39

MURU Haya o Roble

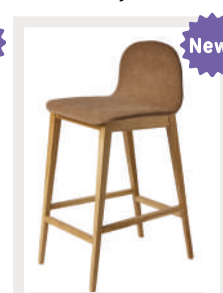

37 39

ZALDO

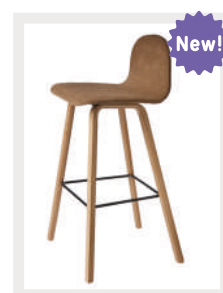

37 39

FAMILIA BELARDI

PAG. 40\_45

BELARDI



42 45

MUGA



42 45

GAZÓN



42 45

LEIZE



43 45

FAMILIA INNO

PAG. 48\_53

CARGO, 65 ó 75



50 53

INNO, 65 ó 75

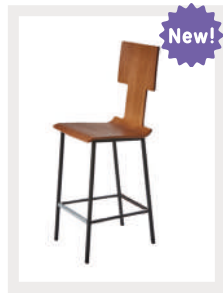

50 53

AUSTIN, 65 ó 75

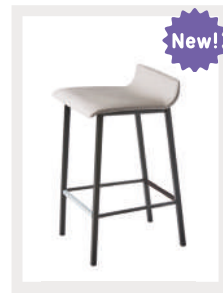

51 53

MARTIN Haya o Roble

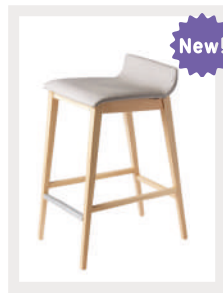

51 53

New! NUEVO  
CATÁLOGO TARIFA

# ÍNDICE TABURETES

**MESINOR**  
TABURETES&BARRAS

## FAMILIA POLY

PAG. 54\_61



56 61  
GALO, 65 ó 75



56 61  
JULHO, 65 ó 75



56 61

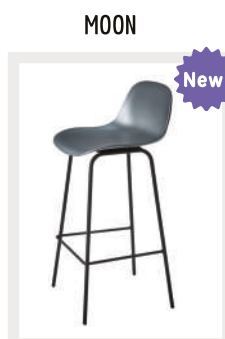

56 61



57 61



58 61

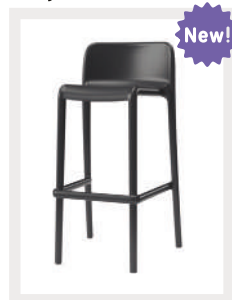

59 61

## FAMILIA FER

PAG. 62\_69



64 69

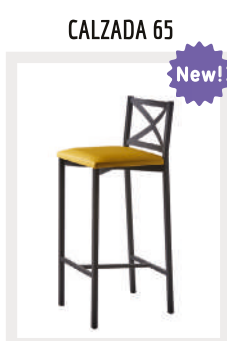

64 69

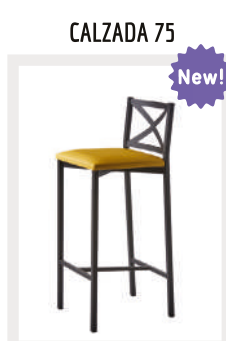

64 69

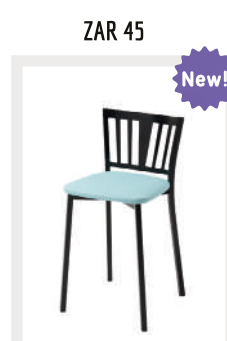

65 69

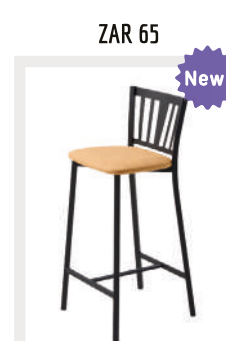

65 69

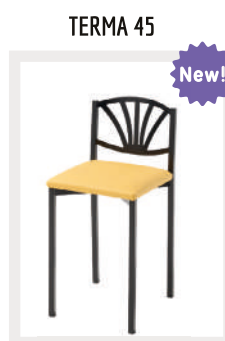

65 69

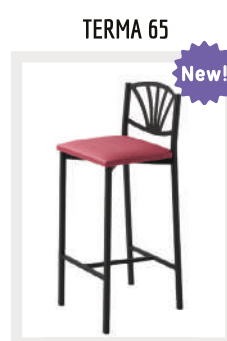

65 69

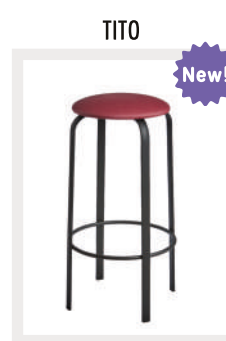

66 69



67 69

## FAMILIA BOIS

PAG. 70\_75



72 75



72 75

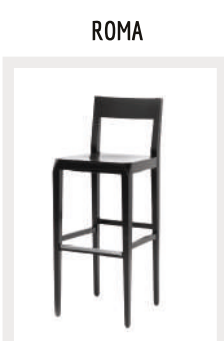

73 75



73 75

**New!** NUEVO  
CATÁLOGO TARIFA



MESA FLORA BARRA ..... PAG. 79\_83 MESA CAPRI BARRA ..... PAG. 85\_88



MESA PLANK PIE DOBLE ..... PAG. 89\_93



MESA PLANK PATAS FIJA ..... PAG. 95\_98



MESA PLANK PATAS EXTENSIBLE LATERAL ..... PAG. 99\_103



MESA PLANK PATAS EXTENSIBLE FRONTAL ..... PAG. 99\_103



MESA PLANK PIE y PLANK PIE 90° ..... PAG. 105\_110



**MESA FOLD PLEGABLE .....**

PAG. 111-112



## ÍNDICE ACABADOS, GUÍAS DE LIMPIEZA Y CONDICIONES GENERALES

**ACABADOS .....**

PAG. 119-137

**GUÍA DEL IMPIEZA Y MANTENIMIENTO.....**

PAG. 138

**CONDICIONES GENERALES.....**

PAG. 139-140

### BARRAS A MEDIDA



### TRABAJAMOS A TU MEDIDA



NUEVO

CATÁLOGO

TARIFA

# FAMILIA HUGO

## TABURETES

- HUGO
- NELL
- MIQUE
- QUELA
- TELLUS
- **MILLÁN**, Haya o Roble
- EROS
- FON

La **familia HUGO** es una de las más populares, descubre y disfruta de sus nuevas opciones en pies tanto en metal como en madera.

**Opciones de carcasa Hugo:** podrás personalizar el taburete eligiendo entre carcasa **Hugo Confort** o **F-40**.





# FAMILIA HUGO PIE METAL

HUGO



MIQUE



NELL



QUELA



TELLUS



# FAMILIA HUGO PIE MADERA

MILLÁN  
Haya



MILLÁN  
Roble



EROS



FON  
parte delantera



FON  
parte trasera



## PERSONALIZA LA CARCASA HUGO

CARCASA HUGO CONFORT



CARCASA F-40



































































## CARACTERÍSTICAS

Modelo	HUGO	NELL	MIQUE	QUELA	TELLUS	MILLÁN	EROS	FON
<b>ARMAZÓN</b> Structure	Metálico Métal	Metálico Métal	Metálico Métal	Metálico Métal	Metálico Métal	Haya Hêtre <b>Roble</b> Chêne	<b>Roble</b> Chêne	Haya Hêtre
<b>ASIENTO</b> Assise	Haya Hêtre <b>Roble</b> Chêne <b>Tapizado</b> Tapissé	Haya Hêtre <b>Roble</b> Chêne <b>Tapizado</b> Tapissé	Haya Hêtre <b>Roble</b> Chêne <b>Tapizado</b> Tapissé	Haya Hêtre <b>Roble</b> Chêne <b>Tapizado</b> Tapissé	<b>Tapizado</b> Tapissé	Haya Hêtre <b>Roble</b> Chêne <b>Tapizado</b> Tapissé	<b>Tapizado</b> Tapissé	Haya Hêtre <b>Roble</b> Chêne <b>Tapizado</b> Tapissé

## DIMENSIONES

Modelo	HUGO altura 65	HUGO altura 75	NELL	MIQUE	QUELA	TELLUS	MILLÁN	EROS	FON
<b>ALTURA TOTAL</b> Hauteur total	104	114	106	106	106	Min. 98 Max. 119	105	113	104
<b>ALTURA HASTA ASIENTO</b> Hauteur d'assise	66	76	66	66	66	Min.60 Max.81	68	77	69
<b>FONDO</b> Profondeur	53	53	53	53	53	47	53	49	52
<b>ANCHO</b> Larguer	39	39	39	39	39	45	39	53	39
<b>PEANA</b> Base	..	..	..	..	..	45	..	..	..
<b>SECCIÓN PATAS</b> Section des pieds	Cuadrado 2x2	Cuadrado 2x2	Cuadrado 2x2	Rectángular 3x1.5	Rectángular 3x1.5	Redondo 4.5	Piramidal 3x2	Rectángular 3.5x2.5	Piramidal 3x2

## PERSONALIZACIÓN DISPONIBLE

HUGO	NELL	MIQUE	QUELA	TELLUS	MILLÁN	EROS	FON
							
 	 	 	 	 	 	 	 
							
 	 	 	 	 	 	 	 
 	 	 	 	 	 	 	 
							



COLOR MUESTRARIO



COLOR MUESTRA CLIENTE



COLOR RAL



ACABADO STEEL



TELA MUESTRARIO



DOBLE TAPICERÍA



TELA COLECCIONES



COSTURAS ESPECIALES



TELA CLIENTE

Modelo	Color		Tapizado 1 Tissu 1	Tapizado 2 Tissu 2	Haya Barniz Hêtre vernis	Roble Barniz Chêne vernis	Colores para madera Coloris bois peint
	Color Pie	Carcasa					
HUGO, ALTURA 65	Negro, Blanco	Aluminio	221	228	205	209	205
HUGO, ALTURA 65	Color Muestrario		271	278	255	259	255
HUGO, ALTURA 75	Negro, Blanco	Aluminio	223	230	207	211	207
HUGO, ALTURA 75	Color Muestrario		273	280	257	261	257
NELL	Negro, Blanco	Aluminio	227	234	211	215	211
NELL	Color Muestrario		277	284	261	265	261
MIQUE	Negro, Blanco	Aluminio	232	239	216	220	216
MIQUE	Color Muestrario		282	289	266	270	266
QUELA	Negro, Blanco	Aluminio	229	236	214	218	214
QUELA	Color Muestrario		279	286	264	268	264
TELLUS	Cromo Brillo		244	251	consultar a fábrica	consultar a fábrica	consultar a fábrica
TELLUS	Negro, Blanco		294	301	consultar a fábrica	consultar a fábrica	consultar a fábrica
TELLUS	Color Muestrario		294	301	consultar a fábrica	consultar a fábrica	consultar a fábrica
MILLÁN. HAYA	Haya Natural		251	258	235	consultar a fábrica	235
MILLÁN. HAYA	Haya Barniz Colores para Madera		282	289	266	consultar a fábrica	266
MILLÁN. ROBLE	Roble Natural		267	274	consultar a fábrica	256	252
MILLÁN. ROBLE	Roble Barniz		300	307	consultar a fábrica	288	284
EROS	Roble Natural		245	252	consultar a fábrica	consultar a fábrica	consultar a fábrica
EROS	Colores para Madera		295	302	consultar a fábrica	consultar a fábrica	consultar a fábrica
FON	Haya Natural		280	287	244	248	244
FON	Haya Barniz Colores para Madera		294	301	278	282	278



HUGO



NELL



MIQUE



QUELA



TELLUS



MILLÁN,  
Haya o Roble



EROS



FON

## Personalización



**Carcasa F40**  
Extra relleno y  
costura horizontal



**Carcasa Hugo Confort**  
Relleno confort y faja  
lateral combinable

### OPCIONES

Tapicería Bicolor	Punto más caro
Extra relleno de 30 mm	30
Carcasa F-40	60
Carcasa Hugo Confort	90
Tela Muestrario Completo	Consultar a fábrica
Tela Cliente	Consultar a fábrica
Acabado Steel	Color Muestrario
Color RAL, Muestra Cliente	Consultar a fábrica
Cortar Patas Taburete Madera. Máximo 10 cm	20



# FAMILIA ARANA

## TABURETES

- ARANA
- IBAR
- HICA
- ANDRA, Haya o Roble
- MINAYA
- ANAYA

La **familia ARANA** es una novedad en diseño que encajará en cualquier espacio. Redondea tu estancia favorita con esta elección.

**Opciones de carcasa Arana:** elige la carcasa **Arana PAD** para darle un toque de diseño.





# FAMILIA ARANA PIE METAL

ARANA



IBAR



HICA



# FAMILIA ARANA PIE MADERA

ANDRA  
Haya



ANDRA  
Roble



MINAYA



ANAYA  
parte  
trasera



ANAYA  
parte  
delantera



CARCASA PAD



ANAYA PAD  
parte  
trasera



ANAYA PAD  
parte  
delantera



# TÉCNICO

## CARACTERÍSTICAS

Modelo	ARANA	IBAR	HICA	ANDRA	MINAYA	ANAYA
<b>ARMAZÓN</b> Structure	<b>Metálico</b> Métal	<b>Metálico</b> Métal	<b>Metálico</b> Métal	<b>Haya</b> Hêtre <b>Roble</b> Chêne	<b>Roble</b> Chêne	<b>Haya</b> Hêtre
<b>ASIENTO</b> Assise	<b>Tapizado</b> Tapissé	<b>Tapizado</b> Tapissé	<b>Tapizado</b> Tapissé	<b>Tapizado</b> Tapissé	<b>Tapizado</b> Tapissé	<b>Tapizado</b> Tapissé

## DIMENSIONES

Modelo	ARANA	IBAR altura 65	IBAR altura 75	HICA	ANDRA	MINAYA	ANAYA
<b>ALTURA TOTAL</b> Hauteur total	106	104	114	Min. 98 Max. 119	105	113	105
<b>ALTURA HASTA ASIENTO</b> Hauteur d'assise	65	66	76	Min. 60 Max. 81	68	77	69
<b>FONDO</b> Profondeur	44	53	53	47	52	48	52
<b>ANCHO</b> Larguer	45	40	40	45	40	53	40
<b>PEANA</b> Base	..	..	..	45	..	..	..
<b>SECCIÓN PATAS</b> Section des pieds	Redondo 1.5	Cuadrado 2x2	Cuadrado 2x2	Redondo 4.5	Piramidal 3x2	Rectangular 3.5x2.5	Piramidal 3x2

## PERSONALIZACIÓN DISPONIBLE

ARANA	IBAR	HICA	ANDRA	MINAYA	ANAYA



COLOR MUESTRARIO



COLOR MUESTRA CLIENTE



COLOR RAL



ACABADO STEEL



TELA MUESTRARIO



DOBLE TAPICERÍA



TELA COLECCIONES



COSTURAS ESPECIALES



TELA CLIENTE

Modelo	Color		Tapizado 1 Tissu 1	Tapizado 2 Tissu 2	Haya Barniz CARCASA PAD Tapizado1	Haya Barniz CARCASA PAD Tapizado2	Roble Barniz CARCASA PAD Tapizado1	Roble Barniz CARCASA PAD Tapizado2
	Color Pie	Carcasa						
ARANA	Negro, Blanco Aluminio		218	225	250	257	256	263
ARANA	Color Muestrario		268	275	300	307	306	313
IBAR, ALTURA 65	Negro, Blanco Aluminio		221	228	253	260	259	266
IBAR, ALTURA 65	Color Muestrario		271	278	303	310	309	316
IBAR, ALTURA 75	Negro, Blanco Aluminio		223	230	255	262	261	268
IBAR, ALTURA 75	Color Muestrario		273	280	305	312	311	318
HICA	Cromo Brillo		244	251	276	283	282	289
HICA	Negro, Blanco		294	301	326	333	332	339
HICA	Color Muestrario		294	301	326	333	332	339
ANDRA. HAYA	Haya Natural		251	258	283	290	consultar a fábrica	consultar a fábrica
ANDRA. HAYA	Haya Barniz Colores para Madera		282	289	314	321	consultar a fábrica	consultar a fábrica
ANDRA. ROBLE	Roble Natural		267	274	consultar a fábrica	consultar a fábrica	305	312
ANDRA. ROBLE	Roble Barniz		300	307	consultar a fábrica	consultar a fábrica	338	345
MINAYA	Roble Natural		245	252	consultar a fábrica	consultar a fábrica	283	290
MINAYA	Colores para Madera		295	302	consultar a fábrica	consultar a fábrica	333	340
ANAYA	Haya Natural		260	267	292	299	consultar a fábrica	consultar a fábrica
ANAYA	Haya Barniz Colores para Madera		294	301	326	333	consultar a fábrica	consultar a fábrica



ARANA



IBAR



HICA



ANDRA,  
Haya o Roble



MINAYA



ANAYA

## Personalización



CARCASA PAD  
Haya

CARCASA PAD  
Roble

OPCIONES	
Tapicería Bicolor	Punto más caro
Extra Relleno de 30 mm	30
Tela Muestrario Completo	Consultar a fábrica
Tela Cliente	Consultar a fábrica
Acabado Steel	Color Muestrario
Color RAL, Muestra Cliente	Consultar a fábrica
Cortar Patas Taburete Madera. Máximo 10 cm	20

# FAMILIA CRUZ

## TABURETES

- **CRUZ**
- **CROSS**
- **CROCE**, Haya o Roble

La **familia CRUZ** está diseñada con una carcasa de una forma original.

Aporta fuerza a tus proyectos.









TABURETE CROSS



TABURETE CROCE



TABURETE CROCE



TABURETE CROCE

# FAMILIA CRUZ PIE METAL Y MADERA

CRUZ



CROSS



CROCE  
Haya o Roble



## PERSONALIZA CON COLOR



# TÉCNICO









## CARACTERÍSTICAS

Modelo	CRUZ	CROSS	CROCE
<b>ARMAZÓN</b> Structure	<b>Metálico</b> Métal	<b>Metálico</b> Métal	<b>Haya</b> Hêtre <b>Roble</b> Chêne
<b>ASIENTO</b> Assise	<b>Haya</b> Hêtre <b>Roble</b> Chêne	<b>Haya</b> Hêtre <b>Roble</b> Chêne	<b>Haya</b> Hêtre <b>Roble</b> Chêne

## DIMENSIONES

Modelo	CRUZ altura 65	CRUZ altura 75	CROSS	CROCE
<b>ALTURA TOTAL</b> Hauteur total	104	114	108	107
<b>ALTURA HASTA ASIENTO</b> Hauteur d'assise	65	75	64	67
<b>FONDO</b> Profondeur	53	53	44	52
<b>ANCHO</b> Larguer	39	39	45	38
<b>SECCIÓN PATAS</b> Section des pieds	Cuadrado 2x2	Cuadrado 2x2	Redondo 1.5	Piramidal 3x2

## PERSONALIZACIÓN DISPONIBLE

CRUZ	CROSS	CROCE
		
 	 	 



COLOR  
MUESTRARIO



COLOR  
MUESTRA CLIENTE



COLOR RAL



ACABADO  
STEEL



TELA  
MUESTRARIO



DOBLE  
TAPICERÍA



TELA  
COLECCIONES



COSTURAS  
ESPECIALES



TELA  
CLIENTE

Modelo	Color Pie / Color Carcasa	Haya Barniz Hêtre vernis	Roble Barniz Chêne vernis	Colores para madera Coloris bois peint
CRUZ. ALTURA 65	Negro, Blanco Aluminio	206	210	206
CRUZ. ALTURA 65	Color Muestrario	256	260	256
CRUZ. ALTURA 75	Negro, Blanco Aluminio	208	212	208
CRUZ. ALTURA 75	Color Muestrario	258	262	258
CROSS	Negro, Blanco Aluminio	203	207	203
CROSS	Color Muestrario	253	257	253
CROCE. HAYA	Haya Natural	236	consultar a fábrica	236
CROCE. HAYA	Haya Barniz Colores para Madera	267	consultar a fábrica	267
CROCE. ROBLE	Roble Natural	consultar a fábrica	256	252
CROCE. ROBLE	Roble Barniz	consultar a fábrica	289	285



CRUZ



CROSS



CROCE,  
Haya o Roble

## Personalización



Elige el COLOR DE LA CARTA RAL

OPCIONES	
Color RAL, Muestra Cliente	Consultar a fábrica
Cortar Patas Taburete Madera. Máximo 10 cm	20

# FAMILIA GEA

## TABURETES

- GEA
- TALES
- ZENÓN
- SAMOS
- HADES
- ZEUS, Haya o Roble
- HERMES

La **familia GEA** es una de las más populares, descubre y disfruta de sus nuevas personalizaciones de pies tanto en metal como en madera.

**Opciones de carcasa GEA:** podrás personalizar el taburete eligiendo entre carcasa **Confort** o **f-20**





# FAMILIA GEA PIE METAL

GEA



TALES



HADES



ZENÓN



SAMOS



# FAMILIA GEA PIE MADERA



**ZEUS**  
Haya o Roble



**HERMES**



## PERSONALIZA LA CARCASA GEA



CARCASA GEA CONFORT



CARCASA F-20



CARACTERÍSTICAS

Modelo	GEA	TALES	ZENÓN	SAMOS	HADES	ZEUS	HERMES
<b>ARMAZÓN</b> Structure	<b>Metálico</b> Métal	<b>Metálico</b> Métal	<b>Metálico</b> Métal	<b>Metálico</b> Métal	<b>Metálico</b> Métal	<b>Haya</b> Hêtre <b>Roble</b> Chêne	<b>Roble</b> Chêne
<b>ASIENTO</b> Assise	<b>Haya</b> Hêtre <b>Roble</b> Chêne <b>Tapizado</b> Tapissé	<b>Haya</b> Hêtre <b>Roble</b> Chêne <b>Tapizado</b> Tapissé	<b>Haya</b> Hêtre <b>Roble</b> Chêne <b>Tapizado</b> Tapissé	<b>Haya</b> Hêtre <b>Roble</b> Chêne <b>Tapizado</b> Tapissé	<b>Tapizado</b> Tapissé	<b>Haya</b> Hêtre <b>Roble</b> Chêne <b>Tapizado</b> Tapissé	<b>Tapizado</b> Tapissé

DIMENSIONES

Modelo	GEA altura 65	GEA altura 75	TALES	ZENÓN	SAMOS	HADES	ZEUS	HERMES
<b>ALTURA TOTAL</b> Hauteur total	87	97	87	87	87	Min. 81 Max. 102	86	96
<b>ALTURA HASTA ASIENTO</b> Hauteur d'assise	66	76	66	66	66	Min. 60 Max. 81	68	77
<b>FONDO</b> Profondeur	53	53	53	53	53	44	52	47
<b>ANCHO</b> Larguer	39	39	39	39	39	45	39	53
<b>PEANA</b> Base	..	..	..	..	..	45	..	..
<b>SECCIÓN PATAS</b> Section des pieds	Cuadrado 2x2	Cuadrado 2x2	Cuadrado 2x2	Rectángular 3x1.5	Rectángular 3x1.5	Redondo 4.5	Piramidal 3x2	Rectángular 3.5x2.5

PERSONALIZACIÓN DISPONIBLE

GEA	TALES	ZENÓN	SAMOS	HADES	ZEUS	HERMES



COLOR MUESTRARIO



COLOR MUESTRA CLIENTE



COLOR RAL



ACABADO STEEL



TELA MUESTRARIO



DOBLE TAPICERÍA



TELA COLECCIONES



COSTURAS ESPECIALES



TELA CLIENTE

Modelo	Color		Tapizado 1 Tissu 1	Tapizado 2 Tissu 2	Haya Barniz Hêtre Vernis	Roble Barniz Chêne Vernis	Colores para madera Coloris bois paint
	Color Pie	Carcasa Aluminio					
<b>GEA, ALTURA 65</b>	Negro, Blanco	Aluminio	212	219	202	208	202
<b>GEA, ALTURA 65</b>	Color Muestrario		262	269	252	258	252
<b>GEA, ALTURA 75</b>	Negro, Blanco	Aluminio	214	221	204	210	204
<b>GEA, ALTURA 75</b>	Color Muestrario		264	271	254	260	254
<b>TALES</b>	Negro, Blanco	Aluminio	218	225	208	214	208
<b>TALES</b>	Color Muestrario		268	275	258	264	258
<b>ZENÓN</b>	Negro, Blanco	Aluminio	223	230	213	219	213
<b>ZENÓN</b>	Color Muestrario		273	280	263	269	263
<b>SAMOS</b>	Negro, Blanco	Aluminio	220	227	210	216	210
<b>SAMOS</b>	Color Muestrario		270	277	260	266	260
<b>HADES</b>	Cromo Brillo		235	242	consultar a fábrica	consultar a fábrica	consultar a fábrica
<b>HADES</b>	Negro, Blanco		285	292	consultar a fábrica	consultar a fábrica	consultar a fábrica
<b>HADES</b>	Color Muestrario		285	292	consultar a fábrica	consultar a fábrica	consultar a fábrica
<b>ZEUS. HAYA</b>	Haya Natural		242	249	232	consultar a fábrica	232
<b>ZEUS. HAYA</b>	Haya Barniz Colores para Madera		273	280	263	consultar a fábrica	263
<b>ZEUS ROBLE</b>	Roble Natural		258	265	consultar a fábrica	254	248
<b>ZEUS ROBLE</b>	Roble Barniz		291	298	consultar a fábrica	287	281
<b>HERMES</b>	Roble Natural		236	243	consultar a fábrica	consultar a fábrica	consultar a fábrica
<b>HERMES</b>	Colores para madera		286	293	consultar a fábrica	consultar a fábrica	consultar a fábrica



GEA



TALES



ZENÓN



SAMOS



HADES



ZEUS,  
Haya o Roble



HERMES

## Personalización



Carcasa F20  
Extra relleno y  
costura horizontal



Carcasa Gea Confort  
Relleno confort y faja  
lateral combinable

### OPCIONES

Tapicería Bicolor	Punto más caro
Extra Relleno de 30 mm	30
Carcasa F-20	50
Carcasa Gea Confort	90
Tela Muestrario Completo	Consultar a fábrica
Tela Cliente	Consultar a fábrica
Acabado Steel	Color Muestrario
Color RAL, Muestra Cliente	Consultar a fábrica
Cortar Patas Taburete Madera. Máximo 10 cm	20

# FAMILIA MENDIA

## TABURETES

- MENDIA
- ZURIA
- BELASA
- GORA
- MURU, Haya o Roble
- ZALDO

La **familia MENDIA** es una novedad que encajará en cualquier espacio. Redondea tu estancia favorita con esta elección.

**Opciones de carcasa Mendia:** elige la carcasa **Mendia PAD** para darle un toque de diseño





# FAMILIA MENDIA PIE METAL

MENDIA



ZURIA



GORA



BELASA



# FAMILIA MENDIA PIE MADERA



## CARCASA PAD



CARACTERÍSTICAS

Modelo	MENDIA	ZURIA	BELASA	GORA	MURU	ZALDO
<b>ARMAZÓN</b> Structure	<b>Metálico</b> Métal	<b>Metálico</b> Métal	<b>Metálico</b> Métal	<b>Metálico</b> Métal	<b>Haya</b> Hêtre <b>Roble</b> Chêne	<b>Roble</b> Chêne
<b>ASIENTO</b> Assise	<b>Tapizado</b> Tapissé	<b>Tapizado</b> Tapissé	<b>Tapizado</b> Tapissé	<b>Tapizado</b> Tapissé	<b>Tapizado</b> Tapissé	<b>Tapizado</b> Tapissé

DIMENSIONES

Modelo	MENDIA	ZURIA altura 65	ZURIA altura 75	BELASA	GORA	MURU	ZALDO
<b>ALTURA TOTAL</b> Hauteur total	89	87	97	Min. 81 Max. 102	88	88	96
<b>ALTURA HASTA ASIENTO</b> Hauteur d'assise	65	66	76	Min. 60 Max. 81	67	68	77
<b>FONDO</b> Profondeur	44	53	53	42	43	52	46
<b>ANCHO</b> Larguer	45	40	40	45	40	40	53
<b>PEANA</b> Base	..	..	..	45	..	..	..
<b>SECCIÓN PATAS</b> Section des pieds	Redondo 1,5	Cuadrado 2x2	Cuadrado 2x2	Redondo 4,5	Rectangular 3x1	Piramidal 3x2	Rectangular 3,5x2,5

PERSONALIZACIÓN DISPONIBLE

MENDIA	ZURIA	BELASA	GORA	MURU	ZALDO



COLOR MUESTRARIO



COLOR MUESTRA CLIENTE



COLOR RAL



ACABADO STEEL



TELA MUESTRARIO



DOBLE TAPICERÍA



TELA COLECCIONES



COSTURAS ESPECIALES



TELA CLIENTE

Modelo	Color		Tapizado 1 Tissu 1	Tapizado 2 Tissu 2	Haya Barniz CARCASA PAD Tapizado1	Haya Barniz CARCASA PAD Tapizado2	Roble Barniz CARCASA PAD Tapizado1	Roble Barniz CARCASA PAD Tapizado2
	Color Pie	Carcasa						
MENDIA	Negro, Blanco	Aluminio	209	216	250	257	254	261
MENDIA	Color Muestrario		259	266	300	307	304	311
ZURIA, ALTURA 65	Negro, Blanco	Aluminio	212	219	253	260	257	264
ZURIA, ALTURA 65	Color Muestrario		262	269	303	310	307	314
ZURIA, ALTURA 75	Negro, Blanco	Aluminio	214	221	255	262	259	266
ZURIA, ALTURA 75	Color Muestrario		264	271	305	312	309	316
BELASA	Cromo Brillo		235	242	276	283	280	287
BELASA	Negro, Blanco		285	292	326	333	330	337
BELASA	Color Muestrario		285	292	326	333	330	337
GORA	Negro, Blanco	Aluminio	219	226	260	267	264	271
GORA	Color Muestrario		269	276	310	317	314	321
MURU. HAYA	Haya Natural		242	249	283	290	consultar a fábrica	consultar a fábrica
MURU. HAYA	Haya Barniz Colores para Madera		273	280	314	321	consultar a fábrica	consultar a fábrica
MURU. ROBLE	Roble Natural		258	265	consultar a fábrica	consultar a fábrica	303	310
MURU. ROBLE	Roble Barniz		291	298	consultar a fábrica	consultar a fábrica	336	343
ZALDO	Roble Natural		236	243	consultar a fábrica	consultar a fábrica	281	288
ZALDO	Colores para Madera		286	293	consultar a fábrica	consultar a fábrica	331	338



MENDIA



ZURIA



BELASA



GORA



MURU,  
Haya o Roble



ZALDO

## Personalización



CARCASA PAD  
Haya



CARCASA PAD  
Roble

OPCIONES	
Tapicería Bicolor	Punto más caro
Extra Relleno de 30 mm	30
Tela Muestrario Completo	Consultar a fábrica
Tela Cliente	Consultar a fábrica
Acabado Steel	Color Muestrario
Color RAL, Muestra Cliente	Consultar a fábrica
Cortar Patas Taburete Madera. Máximo 10 cm	20



# FAMILIA BELARDI

## TABURETES

- BELARDI
- MUGA
- GAZÓN
- LEIZE

La **familia BELARDI** es toda diseño. Su original carcasa sobre un pie cónico creará ambientes únicos.

**Opciones de carcasa Belardi:** elige la carcasa **Belardi PAD** para darle un toque diferente.





# FAMILIA BELARDI PIE METAL

BELARDI



MUGA



GAZÓN



# FAMILIA BELARDI PIE MADERA

LEIZE



## PERSONALIZA LA CARCASA BELARDI















































**CARACTERÍSTICAS**

Modelo	BELARDI	MUGA	GAZÓN	LEIZE
<b>ARMAZÓN</b> Structure	<b>Metálico</b> Métal	<b>Metálico</b> Métal	<b>Metálico</b> Métal	<b>Roble</b> Chêne
<b>ASIENTO</b> Assise	<b>Tapizado</b> Tapissé	<b>Tapizado</b> Tapissé	<b>Tapizado</b> Tapissé	<b>Tapizado</b> Tapissé

**DIMENSIONES**

Modelo	BELARDI	BELARDI GIRATORIO	MUGA	GAZÓN	LEIZE
<b>ALTURA TOTAL</b> Hauteur total	84	85	Min. 78 Max. 99	85	92
<b>ALTURA HASTA ASIENTO</b> Hauteur d'assise	66	67	Min.60 Max. 81	67	77
<b>FONDO</b> Profondeur	43	43	43	43	47
<b>ANCHO</b> Larguer	38	38	45	40	53
<b>PEANA</b> Base	..	..	45	..	..
<b>SECCIÓN PATAS</b> Section des pieds	Redondo 1.5	Redondo 1.5	Redondo 4.5	Rectángular 3x1	Rectángular 3.5x2.5

**PERSONALIZACIÓN DISPONIBLE**

BELARDI	BELARDI GIRATORIO	MUGA	GAZÓN	LEIZE
				
 	 	 	 	 
 	 	 	 	 
 	 	 	 	 
				
				



COLOR MUESTRARIO



COLOR MUESTRA CLIENTE



COLOR RAL



ACABADO STEEL



TELA MUESTRARIO



DOBLE TAPICERÍA



TELA COLECCIONES



COSTURAS ESPECIALES



TELA CLIENTE

Modelo	Color		Tapizado 1 Tissu 1	Tapizado 2 Tissu 2	Haya Barniz CARCASA PAD Tapizado1	Haya Barniz CARCASA PAD Tapizado2	Roble Barniz CARCASA PAD Tapizado1	Roble Barniz CARCASA PAD Tapizado2
	Carcasa	Pie						
<b>BELARDI</b>	Negro, Blanco	Aluminio	222	229	262	269	266	273
<b>BELARDI</b>	Color Muestrario		272	279	312	319	316	323
<b>BELARDI GIRATORIO</b>	Negro, Blanco	Aluminio	262	269	303	310	307	314
<b>BELARDI GIRATORIO</b>	Color Muestrario		312	319	353	360	357	364
<b>MUGA</b>	Cromo		235	242	276	283	280	287
<b>MUGA</b>	Negro, Blanco		285	292	326	333	330	337
<b>MUGA</b>	Color Muestrario		285	292	326	333	330	337
<b>GAZÓN</b>	Negro, Blanco	Aluminio	219	226	260	267	264	271
<b>GAZÓN</b>	Color Muestrario		269	276	310	317	314	321
<b>LEIZE</b>	Roble Natural		220	227	consultar a fabrica	consultar a fabrica	266	273
<b>LEIZE</b>	Colores para Madera		270	277	consultar a fabrica	consultar a fabrica	316	323



BELARDI



MUGA



GAZÓN



LEIZE

## Personalización



CARCASA PAD  
Haya



CARCASA PAD  
Roble



OPCIONES	
Tapicería Bicolor	Punto más caro
Extra Relleno de 30 mm	30
Tela Muestrario Completo	Consultar a fábrica
Tela Cliente	Consultar a fábrica
Color RAL, Muestra Cliente	Consultar a fábrica
Cortar Patas Taburete Madera. Máximo 10 cm	20

# TABURETE IBAR PAD



# CARCASA PAD



MENDIA PAD HAYA



ARANA PAD ROBLE



DETALLE CARCASA PAD



ARANA PAD ROBLE



# FAMILIA INNO

## TABURETES

- CARGO
- INNO
- AUSTIN
- MARTIN

La **familia INNO** es una creación pensada para el proyecto más exigente. Calidad, diseño y acabado personalizados.

**Steel by Mesinor**, es un armazón en acero cepillado con un barniz transparente.

**F20 y F40 by Mesinor**, es una carcasa tapizada con doble acolchado, cosido original y refuerzo.

**Cruz by Mesinor**, es una carcasa original en madera de haya o roble.

**Mini by Mesinor**, es una carcasa de pequeñas dimensiones pero grandes posibilidades.







CARCASA F-40



CARCASA F-20

ACABADO STEEL



# AUSTIN



# MARTIN

















## CARACTERÍSTICAS

Modelo	CARGO	INNO	AUSTIN	MARTIN
<b>ARMAZÓN</b> Structure	<b>Metálico</b> Métal	<b>Metálico</b> Métal	<b>Metálico</b> Métal	<b>Haya</b> Hêtre <b>Roble</b> Chêne
<b>ASIENTO</b> Assise	<b>Tapizado</b> Tapissé	<b>Haya</b> Hêtre <b>Roble</b> Chêne	<b>Haya</b> Hêtre <b>Roble</b> Chêne <b>Tapizado</b> Tapissé	<b>Haya</b> Hêtre <b>Roble</b> Chêne <b>Tapizado</b> Tapissé

## DIMENSIONES

Modelo	CARGO altura 65	CARGO altura 75	INNO altura 65	INNO altura 75	AUSTIN altura 65	AUSTIN altura 75	MARTIN
<b>ALTURA TOTAL</b> Hauteur total	F20=87 F40=104	F20=97 F40=114	106	116	73	83	73
<b>ALTURA HASTA ASIENTO</b> Hauteur d'assise	68	78	65	75	66	76	68
<b>FONDO</b> Profondeur	53	53	53	53	53	53	52
<b>ANCHO</b> Larguer	39	39	39	39	39	39	39
<b>SECCIÓN PATAS</b> Section des pieds	Cuadrado 2x2	Cuadrado 2x2	Cuadrado 2x2	Cuadrado 2x2	Cuadrado 2x2	Cuadrado 2x2	Piramidal 3x2

## PERSONALIZACIÓN DISPONIBLE

CARGO	INNO	AUSTIN	MARTIN
			
			
			
			



COLOR MUESTRARIO



COLOR MUESTRA CLIENTE



COLOR RAL



ACABADO STEEL



TELA MUESTRARIO



DOBLE TAPICERÍA



TELA COLECCIONES



COSTURAS ESPECIALES



TELA CLIENTE

Modelo	Color Carcasa Color Pie	Tapizado 1 Tissu 1	Tapizado 2 Tissu 2	Haya Barniz Hêtre vernis	Roble Barniz Chêne vernis	Colores para madera Coloris bois peint
<b>CARGO, ALTURA 65</b>	Steel	326	333	consultar a fabrica	consultar a fabrica	consultar a fabrica
<b>CARGO, ALTURA 75</b>	Steel	328	335	consultar a fabrica	consultar a fabrica	consultar a fabrica
<b>INNO, ALTURA 65</b>	Steel	consultar a fabrica	consultar a fabrica	256	260	256
<b>INNO, ALTURA 75</b>	Steel	consultar a fabrica	consultar a fabrica	258	262	258
<b>AUSTIN. ALTURA 65</b>	Negro, Blanco Aluminio	212	219	202	208	202
<b>AUSTIN. ALTURA 65</b>	Color Muestrario	262	269	252	258	252
<b>AUSTIN. ALTURA 75</b>	Negro, Blanco Aluminio	214	221	204	210	204
<b>AUSTIN. ALTURA 75</b>	Color Muestrario	264	271	254	260	254
<b>MARTIN. HAYA</b>	Haya Natural	242	249	232	consultar a fabrica	232
<b>MARTIN. HAYA</b>	Haya Barniz Colores para madera	273	280	263	consultar a fabrica	263
<b>MARTIN. ROBLE</b>	Roble Natural	258	265	consultar a fabrica	254	248
<b>MARTIN. ROBLE</b>	Roble Barniz	291	298	consultar a fabrica	287	281



CARGO



INNO



AUSTIN



MARTIN,  
Haya o Roble

**MESINOR.com**



mesas y sillas

OPCIONES	
Tapicería Bicolor	Punto más caro
Extra de Relleno de 30 mm	30
Tela Muestrario Completo	Consultar a fábrica
Tela Cliente	Consultar a fábrica
Acabado Steel	Color Muestrario
Color RAL, Muestra Cliente	Consultar a fábrica
Cortar Patas Taburete Madera. Máximo 10 cm	20

# FAMILIA POLY

## TABURETES

- ARCO
- LITO
- STAR
- MOON
- SUN
- GALO
- JULHO



La **familia POLY** es una colección moderna y ligera.  
Combinan bien en cualquier lugar y espacio.

Personaliza su carcasa con nuestros colores texturizados o añade un cojín tapizado







# FAMILIA POLY PIE METAL

STAR



MOON



ARCO



LITO



TRATAMIENTO ESPECIAL  
EXTERIORES

LOS TABURETES ARCO, LITO, STAR Y MOON  
PUEDEN LLEVAR UN TRATAMIENTO ESPECIAL  
PARA EXTERIORES



OPCIÓN COJÍN TABURETE MOON



OPCIÓN COJÍN TABURETE SUN Y STAR

# FAMILIA POLY PIE MADERA

SUN



# FAMILIA POLY PIE POLIPROPILENO

GALO



GALO color Turtle Dove 802



GALO color Black 900



GALO color White 100



# FAMILIA POLY PIE POLIPROPILENO

JULHO



JULHO color Antracite 100



JULHO color Branco 10



JULHO color Cinza g1



# TÉCNICO





















## CARACTERÍSTICAS

Modelo	ARCO	LITO	STAR	MOON	SUN	GALO	JULHO
<b>ARMAZÓN</b> Structure	<b>Metálico</b> Métal	<b>Metálico</b> Métal	<b>Metálico</b> Métal	<b>Metálico</b> Métal	<b>Roble</b> Chêne	<b>Polipropileno</b> Polypropylène	<b>Polipropileno</b> Polypropylène
<b>ASIENTO</b> Assise	<b>Polipropileno</b> Polypropylène	<b>Polipropileno (negro o blanco)</b> Polypropylène (noir ou blanc)	<b>Polipropileno</b> Polypropylène	<b>Polipropileno</b> Polypropylène	<b>Polipropileno</b> Polypropylène	<b>Polipropileno</b> Polypropylène	<b>Polipropileno</b> Polypropylène

## DIMENSIONES

Modelo	ARCO	LITO	STAR	MOON	SUN	GALO altura 65	GALO altura 75	JULHO altura 65	JULHO altura 75
<b>ALTURA TOTAL</b> Hauteur total	Min. 82 Max.104	Min. 83 Max.104	77	94	82	67	77	86	96
<b>ALTURA HASTA ASIENTO</b> Hauteur d'assise	Min. 60 Max.81	Min. 62 Max.83	77	74	74	67	77	67	77
<b>FONDO</b> Profondeur	45	45	44	45	47	42	42	50	50
<b>ANCHO</b> Larguer	45	45	45	45	53	42	42	Atrás 45 Asiento 41	Atrás 45 Asiento 41
<b>PEANA</b> Base	45	45	..	..	..	..	..	..	..
<b>SECCIÓN PATAS</b> Section des pieds	Redondo 4.5	Redondo 4.5	Redondo 1.5	Redondo 1.5	Rectangular 3.5X2.5	Piramidal 4x2.5	Piramidal 4x2.5	Piramidal 4.5X3.5	Piramidal 4.5X3.5

## PERSONALIZACIÓN DISPONIBLE

ARCO	LITO	STAR	MOON	SUN	GALO	JULHO
						
 	 	 	 	 	 	 



Modelo	Color		Blanco Blanc	Negro Noir	Colores para polipropileno Coloris poly peint
	Color Pie	Color Carcasa			
ARCO	Cromo Brillo		164	164	202
ARCO	Negro, Blanco		214	214	252
ARCO	Color Muestrario		214	214	252
LITO	Cromo Brillo		172	172	consultar a fábrica
LITO	Negro, Blanco		222	222	consultar a fábrica
LITO	Color Muestrario		222	222	consultar a fábrica
STAR	Negro, Blanco, Aluminio		133	133	171
STAR	Color Muestrario		183	183	221
MOON	Negro, Blanco, Aluminio		133	133	171
MOON	Color Muestrario		183	183	221
SUN	Roble Natural		159	159	197
SUN	Colores para Madera		209	209	247

Modelo	Color Taburete	Tarifa
GALO 65	Black 900 / White 100 / Antracite 954 / Turtle Dove 802	137
GALO 65	Color Muestrario	204
GALO 75	Black 900 / White 100 / Antracite 954 / Turtle Dove 802	147
GALO 75	Color Muestrario	214
JULHO 65	Branco 10 / Antracite 100 / Cinza 91	148
JULHO 65	Color Muestrario	215
JULHO 75	Branco 10 / Antracite 100 / Cinza 91	158
JULHO 75	Color Muestrario	225



## Personalización

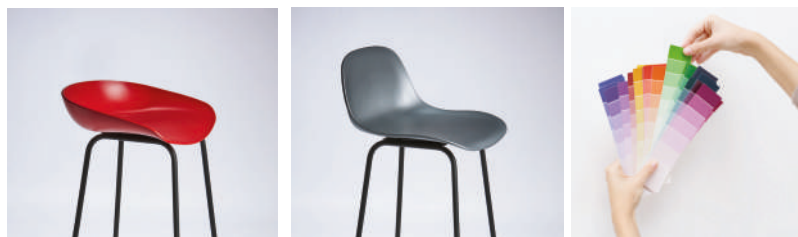

Elige el COLOR DE LA CARTA RAL



Utiliza la TAPICERÍA ESPECIALIZADA

OPCIONES	
Cojín (disponible en Moon, Star y Sun)	60
Color RAL, Muestra Cliente	Consultar a fábrica
Cortar Patas Taburete Madera o Polipropileno. Máximo 10 cm	20
Tratamiento Especial Exteriores (Disponible en Arco, Lito, Moon, Star y Sun)	Consultar a fábrica

# FAMILIA FER

## TABURETES

- CALZADA 45
- CALZADA 65
- CALZADA 75
- ZAR 45
- ZAR 65
- TERMA 45
- TERMA 65
- TITO
- JACOB GIRATORIO

La **familia FER** aporta un clásico en metal que nunca pasa de moda.







# FAMILIA FER PIE METAL

# CALZADA

CALZADA 65



CALZADA 45



CALZADA 75



## TAPICERÍA PERSONALIZABLE



Asiento modelo cojín cuadrado

# FAMILIA FER PIE METAL

# ZAR

ZAR 65



ZAR 45

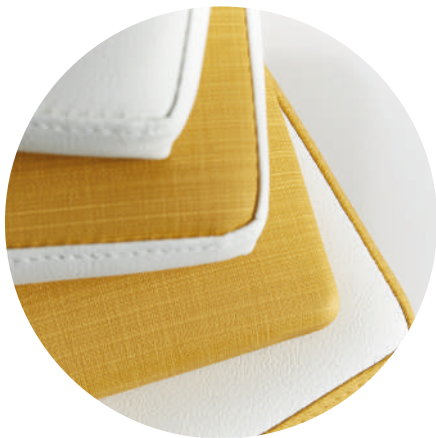

## TAPICERÍA PERSONALIZABLE

Asiento modelo cojin redondo  
Asiento modelo cojin cuadrado

# TERMA

TERMA 65



TERMA 45



# FAMILIA FER PIE METAL



## TITO

*Tito Asiento  
Giratorio*



### TAPICERÍA PERSONALIZABLE



Asiento modelo cojín redondo

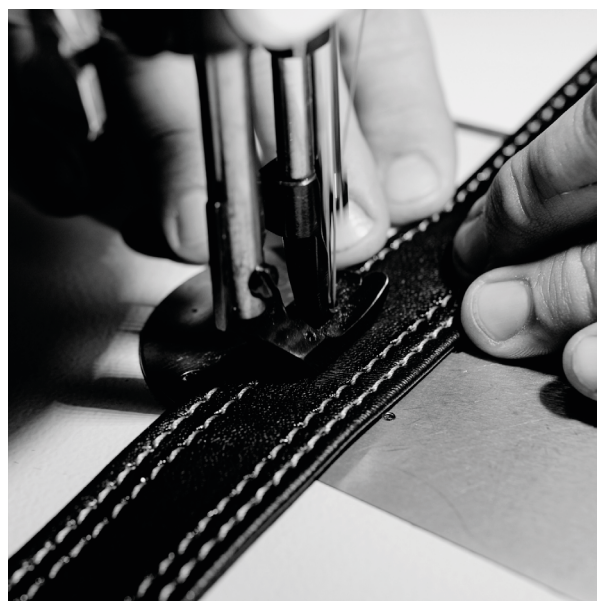

Asiento modelo cojín redondo

# JACOB GIRATORIO

## JACOB



Pie epoxi **gris ANTRACITA**  
Tapizado **BEIGE VINTAGE N30**



Pie epoxi **gris ANTRACITA**  
Tapizado **GRIS VINTAGE N30**



Pie epoxi **gris ANTRACITA**  
Tapizado **JAUNE VINTAGE N30**



Pie epoxi **gris ANTRACITA**  
Tapizado **BLEU VINTAGE N30**



**PINTURA**  
**MESINOR**

## TÉCNICO











































### CARACTERÍSTICAS

Modelo	CALZADA	ZAR	TERMA	TITO	JACOB GIRATORIO
<b>ARMAZÓN</b> Structure	<b>Metálico</b> Métal	<b>Metálico</b> Métal	<b>Metálico</b> Métal	<b>Metálico</b> Métal	<b>Metálico</b> Métal
<b>ASIENTO</b> Assise	<b>Haya</b> Hêtre <b>Roble</b> Chêne <b>Tapizado</b> Tapissé	<b>Haya</b> Hêtre <b>Tapizado</b> Tapissé	<b>Haya</b> Hêtre <b>Roble</b> Chêne <b>Tapizado</b> Tapissé	<b>Haya</b> Hêtre <b>Tapizado</b> Tapissé	<b>Tapizado</b> Tapissé

### DIMENSIONES

Modelo	CALZADA altura 45	CALZADA altura 65	CALZADA altura 75	ZAR altura 45	ZAR altura 65	TERMA altura 45	TERMA altura 65	TITO	TITO GIRATORIO	JACOB GIRATORIO
<b>ALTURA TOTAL</b> Hauteur total	69	87	97	69	87	70	88	76	77	103
<b>ALTURA HASTA ASIENTO</b> Hauteur d'assise	49	67	77	49	67	49	67	76	77	68
<b>FONDO</b> Profondeur	39	39	39	39	39	39	39	40	40	53
<b>ANCHO</b> Larguer	34	34	34	36	37	34	34	40	40	44
<b>SECCIÓN PATAS</b> Section des pieds	Cuadrado 2x2	Cuadrado 2x2	Cuadrado 2x2	Cuadrado 2x2	Cuadrado 2x2	Cuadrado 2x2	Cuadrado 2x2	Rectangular 3x1	Rectangular 3x1	Redondo 2x1,5

### PERSONALIZACIÓN DISPONIBLE

CALZADA	ZAR	TERMA	TITO/TITO GIRATORIO	JACOB GIRATORIO
				
				
				
				
				
				
				
				
				



COLOR MUESTRARIO



COLOR MUESTRA CLIENTE



COLOR RAL



ACABADO STEEL



TELA MUESTRARIO



DOBLE TAPICERÍA



TELA COLECCIONES



COSTURAS ESPECIALES



TELA CLIENTE

Modelo	Color		Tapizado 1 Tissu 1	Tapizado 2 Tissu 2	Haya Barniz Hêtre Vernis	Roble Barniz Chêne Vernis	Colores para madera Coloris bois peint	Tapizado Vintage Tissu Vintage
	Color Pie	Color Carcasa						
<b>CALZADA ALTURA, 45</b>	Negro, Blanco Aluminio		132	134	142	202	142	no disponible
<b>CALZADA ALTURA, 45</b>	Color Muestrario		182	184	192	252	192	no disponible
<b>CALZADA ALTURA, 65</b>	Negro, Blanco Aluminio		152	154	162	222	162	no disponible
<b>CALZADA ALTURA, 65</b>	Color Muestrario		202	204	212	272	212	no disponible
<b>CALZADA ALTURA, 75</b>	Negro, Blanco Aluminio		158	160	168	228	168	no disponible
<b>CALZADA ALTURA, 75</b>	Color Muestrario		208	210	218	278	218	no disponible
<b>ZAR ALTURA, 45</b>	Negro, Blanco Aluminio		134	136	144	no disponible	144	no disponible
<b>ZAR ALTURA, 45</b>	Color Muestrario		184	186	194	no disponible	194	no disponible
<b>ZAR ALTURA, 65</b>	Negro, Blanco Aluminio		154	156	164	no disponible	164	no disponible
<b>ZAR ALTURA, 65</b>	Color Muestrario		204	206	214	no disponible	214	no disponible
<b>TERMA ALTURA, 45</b>	Negro, Blanco Aluminio		135	137	145	205	145	no disponible
<b>TERMA ALTURA, 45</b>	Color Muestrario		185	187	195	255	195	no disponible
<b>TERMA ALTURA, 65</b>	Negro, Blanco Aluminio		155	157	165	225	165	no disponible
<b>TERMA ALTURA, 65</b>	Color Muestrario		205	207	215	275	215	no disponible
<b>TITO</b>	Negro, Blanco Aluminio		145	147	155	consultar a fábrica	155	no disponible
<b>TITO</b>	Color Muestrario		195	197	205	consultar a fábrica	205	no disponible
<b>TITO GIRATORIO</b>	Negro, Blanco Aluminio		186	188	196	consultar a fábrica	196	no disponible
<b>TITO GIRATORIO</b>	Color Muestrario		236	238	246	consultar a fábrica	246	no disponible
<b>JACOB GIRATORIO</b>	Epoxi Gris Antracita		no disponible	no disponible	no disponible	no disponible	no disponible	267
<b>JACOB GIRATORIO</b>	Color Muestrario		no disponible	no disponible	no disponible	no disponible	no disponible	317



## PERSONALIZACIÓN



Asiento modelo  
Cojin Redondo



Asiento modelo  
Cojin cuadrado

OPCIONES	
Tapicería Bicolor	Punto más caro
Extra Relleno 30 mm	30
Asiento modelo Cojin Cuadrado	90
Asiento modelo Cojin Redondo	90
Tela Muestrario Completo	Consultar a fábrica
Tela Cliente	Consultar a fábrica
Color RAL, Muestra Cliente	Consultar a fábrica

# FAMILIA BOIS

## TABURETES

- **TIRÓN**
- **ERIKA**, Haya o Roble
- **ROMA**
- **MANACOR**

La **familia BOIS** aporta un clásico en madera que nunca pasa de moda







# FAMILIA BOIS PIE MADERA

TIRÓN



ERIKA



# FAMILIA BOIS PIE MADERA

ROMA



MANACOR





























**CARACTERÍSTICAS**

Modelo	TIRÓN	ERIKA	ROMA	MANACOR
<b>ARMAZÓN</b> Structure	Haya Hêtre	Haya Hêtre <b>Roble</b> Chêne	Haya Hêtre	Haya Hêtre
<b>ASIENTO</b> Assise	<b>Tapizado</b> Tapissé	Haya Hêtre <b>Tapizado</b> Tapissé	Haya Hêtre <b>Tapizado</b> Tapissé	Haya Hêtre <b>Roble</b> Chêne <b>Tapizado</b> Tapissé

**DIMENSIONES**

Modelo	TIRÓN	ERIKA	ROMA	MANACOR
<b>ALTURA TOTAL</b> Hauteur total	92	92	103	80
<b>ALTURA HASTA ASIENTO</b> Hauteur d'assise	69	68	76	80
<b>FONDO</b> Profondeur	53	49	44	36
<b>ANCHO</b> Larguer	49	Atrás 49 Asiento 40	41	36
<b>SECCIÓN PATAS</b> Section des pieds	Redondo 4x2	Piramidal 5x3.5	Piramidal 2.4x3.8	Piramidal 3.5x3.5

**PERSONALIZACIÓN DISPONIBLE**

TIRÓN	ERIKA	ROMA	MANACOR
			
 	 	 	 
 			 
 			
			



COLOR MUESTRARIO



COLOR MUESTRA CLIENTE



COLOR RAL



ACABADO STEEL



TELA MUESTRARIO



DOBLE TAPICERÍA



TELA COLECCIONES



COSTURAS ESPECIALES



TELA CLIENTE

Modelo	Color Asiento		Tapizado 1 Tissu 1	Tapizado 2 Tissu 2	Haya Barniz Hêtre vernis	Roble Barniz Chêne vernis	Colores para madera Coloris bois peint
	Color Pie						
<b>TIRÓN</b>	Haya Natural		442	470	consultar a fábrica	consultar a fábrica	consultar a fábrica
<b>TIRÓN</b>	Haya Barniz Colores para Madera		492	520	consultar a fábrica	consultar a fábrica	consultar a fábrica
<b>ERIKA. HAYA</b>	Haya Natural		214	216	224	consultar a fábrica	224
<b>ERIKA. HAYA</b>	Haya Barniz Colores para Madera		246	248	256	consultar a fábrica	256
<b>ERIKA. ROBLE</b>	Roble Natural		232	234	consultar a fábrica	consultar a fábrica	241
<b>ERIKA. ROBLE</b>	Roble Barniz		267	269	consultar a fábrica	consultar a fábrica	276
<b>ROMA</b>	Haya Natural		211	213	221	consultar a fábrica	221
<b>ROMA</b>	Haya Barniz Colores para madera		243	245	253	consultar a fábrica	253
<b>MANACOR</b>	Haya Natural		182	184	192	252	192
<b>MANACOR</b>	Haya Barniz Colores para madera		214	216	224	284	224



TIRÓN



ERIKA  
Haya o Roble



ROMA



MANACOR

## Personalización



Combinación de tapizados



Elige el COLOR DE LA CARTA RAL

OPCIONES	
Tapicería Bicolor	Punto más caro
Extra Relleno 30 mm	30
Asiento modelo Cojín Cuadrado	90 Disponible SÓLO EN TABURETE MANACOR
Tela Muestrario Completo	Consultar a fábrica
Tela Cliente	Consultar a fábrica
Color RAL, Muestra Cliente	Consultar a fábrica
Cortar Patas Taburete Madera. Máximo 10 cm	20

# BARRAS

**MESA FLORA  
BARRA**

**MESA CAPRI  
BARRA**

**MESA PLANK  
PIE DOBLE**

**MESA PLANK  
PATAS**  
EXTENSIBLE  
FIJA

**MESA PLANK  
PIE**

**MESA FOLD  
PLEGABLE**







# MESA FLORA BARRA

## ENCIMERA

- Laminado 3 categorías.
- Haya y Roble. (Barniz mate) <sup>New!</sup>
- Cristal Brillo, Mate <sup>New!</sup> y Antirayas.
- Porcelánico 3 mm + Cristal 5 mm.
- Arklam 12 mm <sup>New!</sup>
- Laminam 12 mm <sup>New!</sup>
- Silestone 12 mm
- Dekton 8 mm y Dekton 12 mm

## ESTRUCTURA

- Armazón metálico.

## PATAS

- Patas metálicas.



Mesa Flora Barra altura 102, encimera Dekton Valterra. Taburetes Sun







Mesa Flora Barra altura 90, encimera Dekton Kairos. Taburete Millán carcasa Hugo Confort tapizado Winston Humo.



# Técnico

## MESA FLORA BARRA

MEDIDA MÍNIMA 70x35  
MEDIDA MÁXIMA 200x100

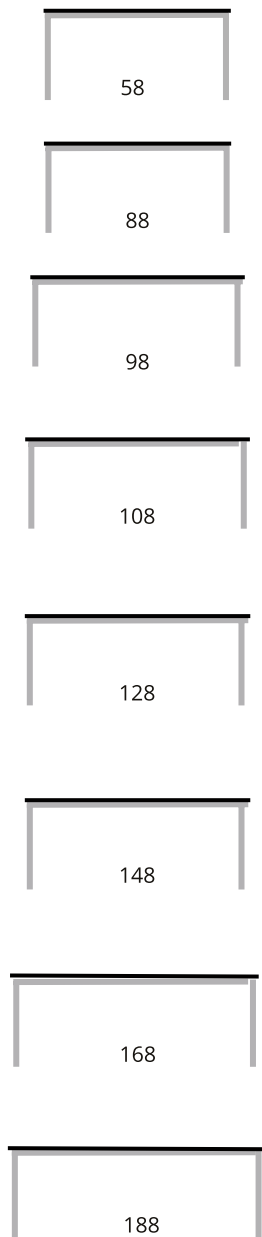
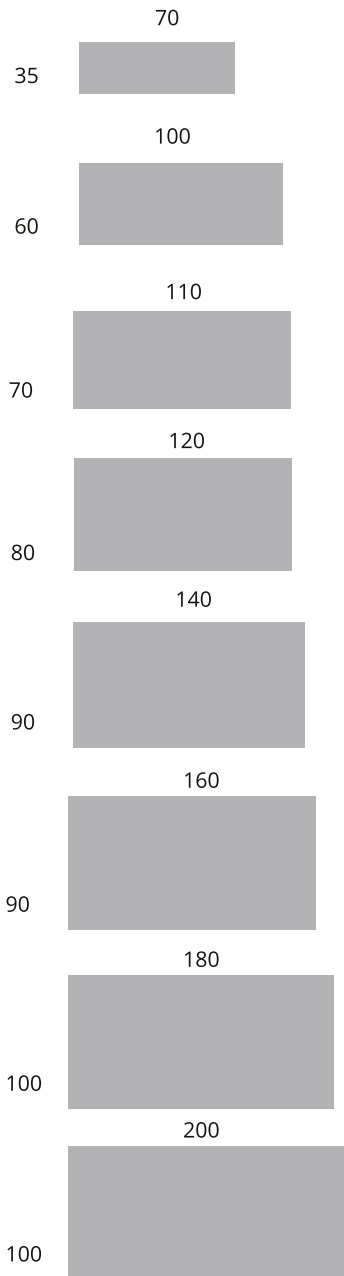

MEDIDA PATAS H-90

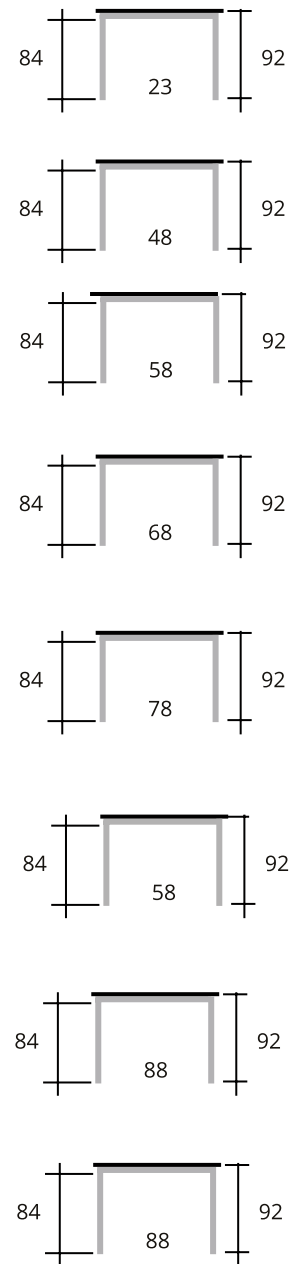

### MEDIDAS ESPECIALES EN LA MESA FLORA BARRA DESDE 70X35 HASTA 200X100

ALTURA ESPECIAL DE MESA DESDE 92 HASTA 112 (Sólo PATAS METÁLICAS)	Medidas Pata	90	95	100	105	110
	Altura Mesa	92	97	102	107	112
	Hueco Interior	84	89	94	99	104

### ENCIMERA EMBUTIDA



### DESPIECE



Encimera  
• Laminado  
• Cristal  
• Porcelánico



Patas tubo cuadrado  
de 5x5 cm.  
• Metálicas



Armazón de 6 cm  
• Metálico

## ENCIMERA LAMINADO

### FIJAS

Armazón y patas NEGRO-BLANCO-ALUMINIO					HYDROBARNIZ MESINOR	HYDROBARNIZ MESINOR
Medidas	Encimera embutida	Laminado cat.1	Laminado cat.2	Laminado cat.3	Haya Barniz Colores madera <small>New!</small>	Roble Barniz <small>New!</small>
100x60	439	471	490	542	578	588
110x70	452	486	511	578	600	613
120x80	466	502	531	615	623	638
140x90	482	524	563	673	656	677
160x90	523	548	591	717	687	710
180x100	542	621	678	847	789	820
200x100	558	756	820	1007	922	957

Armazón y patas PINTURA MUESTRARIO					HYDROBARNIZ MESINOR	HYDROBARNIZ MESINOR
Medidas	Encimera embutida	Laminado cat.1	Laminado cat.2	Laminado cat.3	Haya Barniz Colores madera <small>New!</small>	Roble Barniz <small>New!</small>
100x60	531	563	582	634	670	680
110x70	544	578	603	670	692	705
120x80	558	594	623	707	715	730
140x90	574	616	655	765	748	769
160x90	615	640	683	809	779	802
180x100	634	713	770	939	881	912
200x100	650	848	912	1099	1014	1049

## ENCIMERA CRISTAL

### FIJAS

Armazón y patas NEGRO-BLANCO-ALUMINIO			
Medidas	Brillo Todos los Colores Blanco óptico	Mate <small>New!</small> Todos los Colores Blanco óptico	Antirayas <small>New!</small> Todos los Colores Blanco óptico
100x60	535	590	649
110x70	557	627	717
120x80	580	661	781
140x90	620	721	901

Armazón y patas PINTURA MUESTRARIO			
Medidas	Brillo Todos los Colores Blanco óptico	Mate <small>New!</small> Todos los Colores Blanco óptico	Antirayas <small>New!</small> Todos los Colores Blanco óptico
100x60	627	682	741
110x70	649	719	809
120x80	672	753	873
140x90	712	813	993

#### ¡IMPORTANTE!

 MEDIDAS ESPECIALES DESDE 70x35 HASTA 200x100

 ALTURA ESPECIAL PATAS DESDE 90 HASTA 110

 MEDIDAS ESPECIALES. CONSULTAR A FÁBRICA.

**CLEAF**

**FENIX NTM®**

**ALVIC  
CENTER**

**E EGGER**

**FINSA**  
soluciones en madera

**SONAE  
ARAUCO**  
Taking wood further

**LuxRaff®**



**MERKACRISTAL®**

**Verdú®**  
HERRAJES PARA MUEBLES

# ENCIMERA PORCELÁNICO



MESINOR  
TABURETES&BARRAS

## FIJAS

Medidas	Categoría	100x60	110x70	120x80	140x90	160x90
		PORCELÁNICO 3+5	Cat.1	639	714	781
PORCELÁNICO 3+5	Cat. 2	677	766	832	930	1001
PORCELÁNICO 3+5	Cat. 3	704	805	877	987	1064
LAMINAM 12 mm 	G0-G1	853	941	1039	1189	1292
LAMINAM 12 mm 	G2	948	1062	1189	1386	1516
ARKLAM 12 mm 	Todas	692	756	826	1179	1298
SILESTONE 12 mm	G1	692	753	822	925	995
SILESTONE 12 mm	G2	712	780	854	966	1048
SILESTONE 12 mm	G3	727	800	878	998	1084
SILESTONE 12 mm	G4	762	841	934	1072	1163
SILESTONE 12 mm	G5	783	871	969	1113	1216
SILESTONE 12 mm	G6	833	930	1042	1213	1331
DEKTON 8 mm	G0	728	799	875	989	1072
DEKTON 8 mm	G1	769	852	936	1075	1166
DEKTON 8 mm	G2	799	893	986	1142	1245
DEKTON 8 mm	G3	840	940	1048	1222	1337
DEKTON 8 mm	G4	893	1010	1134	1336	1466
DEKTON 12 mm	G0	780	862	945	1083	1175
DEKTON 12 mm	G1	824	918	1016	1178	1281
DEKTON 12 mm	G2	862	968	1081	1260	1375
DEKTON 12 mm	G3	909	1021	1148	1351	1481
DEKTON 12 mm	G4	968	1103	1248	1478	1625

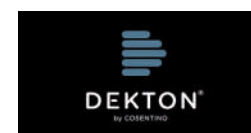
Armazón y patas NEGRO-BLANCO-ALUMINIO



Medidas	Categoría	100x60	110x70	120x80	140x90	160x90
PORCELÁNICO 3+5	Cat.1	731	806	873	946	1006
PORCELÁNICO 3+5	Cat. 2	769	858	924	1022	1093
PORCELÁNICO 3+5	Cat. 3	796	897	969	1079	1156
LAMINAM 12 mm 	G0-G1	945	1033	1131	1281	1384
LAMINAM 12 mm 	G2	1040	1154	1281	1478	1608
ARKLAM 12 mm 	Todas	784	848	918	1271	1390
SILESTONE 12 mm	G1	784	845	914	1017	1087
SILESTONE 12 mm	G2	804	872	946	1058	1140
SILESTONE 12 mm	G3	819	892	970	1090	1176
SILESTONE 12 mm	G4	854	933	1026	1164	1255
SILESTONE 12 mm	G5	875	963	1061	1205	1308
SILESTONE 12 mm	G6	925	1022	1134	1305	1423
DEKTON 8 mm	G0	820	891	967	1081	1164
DEKTON 8 mm	G1	861	944	1028	1167	1258
DEKTON 8 mm	G2	891	985	1078	1234	1337
DEKTON 8 mm	G3	932	1032	1140	1314	1429
DEKTON 8 mm	G4	985	1102	1226	1428	1558
DEKTON 12 mm	G0	872	954	1037	1175	1267
DEKTON 12 mm	G1	916	1010	1108	1270	1373
DEKTON 12 mm	G2	954	1060	1173	1352	1467
DEKTON 12 mm	G3	1001	1113	1240	1443	1573
DEKTON 12 mm	G4	1060	1195	1340	1570	1717

Armazón y patas PINTURA MUESTRARIO

### ¡IMPORTANTE!

- MEDIDAS ESPECIALES DESDE 70x35 HASTA 200x100
- ALTURA ESPECIAL PATAS DESDE 75 HASTA 110
- MEDIDAS ESPECIALES CONSULTAR A FÁBRICA.

**ACABADO SUEDE EN DEKTON Y SILESTONE INCREMENTA 5%**

### OPCIONES

Canto Chaflán	160
Patas de Rueda con Freno	150



# MESA CAPRI BARRA

## ENCIMERA

- Laminado 3 categorías.
- Haya y Roble. (Barniz mate) New!
- Cristal Brillo, Mate New! y Antirrayas.
- Porcelánico 3 mm + Cristal 5 mm.
- Arklam 12 mm New!
- Laminam 12 mm New!
- Silestone 12 mm
- Dekton 8 mm y Dekton 12 mm

## ESTRUCTURA

- Armazón metálico.

## PATAS

- Patas metálicas.



Mesa Capri Barra altura 90, encimera Porcelánico Basic Neu. Taburetes Mique.



# Técnico

## MESA CAPRI BARRA

MEDIDA MÍNIMA 80x80  
MEDIDA MÁXIMA 200x100

MEDIDA PATAS H-90

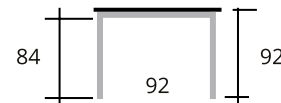
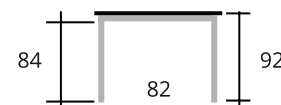
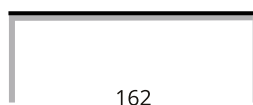
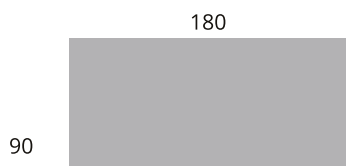
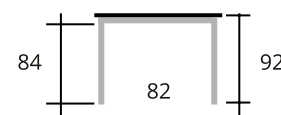
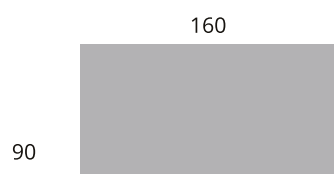
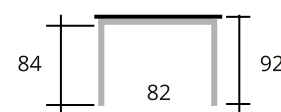
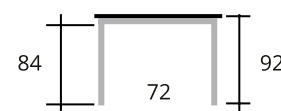
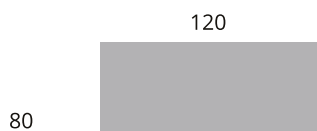
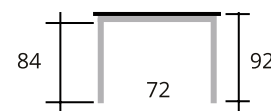
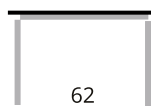
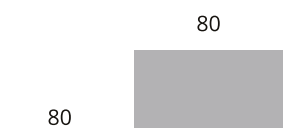

**MEDIDAS ESPECIALES EN LA MESA CAPRI BARRA DESDE 80x80 HASTA 200X100**

**SOLO SE FABRICA EN ALTURA DE 92 CM (PATA DE 90 CM)**

## DESPIECE



Encimera  
• Laminado  
• Cristal  
• Porcelánico



Patas tubo rectangular de 9x4 cm.  
• Metálicas



Armazón de 6 cm  
• Metálico de aluminio

## ENCIMERA LAMINADO

### FIJAS

Armazón y patas NEGRO-BLANCO-ALUMINIO						HYDROBARNIZ MESINOR	HYDROBARNIZ MESINOR
Medidas	Laminado cat.1	Laminado cat.2	Laminado cat.3	Haya Barniz Colores madera	Roble Barniz	New!	New!
120x80	719	749	833	860	876		
140x90	750	789	899	896	917		
160x90	799	842	968	960	983		
180x90	847	901	1058	1023	1052		
200x100	896	956	1131	1082	1114		

Armazón y patas PINTURA MUESTRARIO						HYDROBARNIZ MESINOR	HYDROBARNIZ MESINOR
Medidas	Laminado cat.1	Laminado cat.2	Laminado cat.3	Haya Barniz Colores madera	Roble Barniz	New!	New!
120x80	827	857	941	968	984		
140x90	858	897	1007	1004	1025		
160x90	907	950	1076	1068	1091		
180x90	955	1009	1166	1131	1160		
200x100	1004	1064	1239	1190	1222		

## ENCIMERA CRISTAL

### FIJAS

Armazón y patas NEGRO-BLANCO-ALUMINIO			
Medidas	Brillo Todos los Colores Blanco óptico	Mate Todos los Colores Blanco óptico	Antirayas Todos los Colores Blanco óptico
120x80	801	891	998
140x90	849	961	1127

Armazón y patas PINTURA MUESTRARIO			
Medidas	Brillo Todos los Colores Blanco óptico	Mate Todos los Colores Blanco óptico	Antirayas Todos los Colores Blanco óptico
120x80	909	999	1106
140x90	957	1069	1235

#### ¡IMPORTANTE!

 MEDIDAS ESPECIALES DESDE 80x80 HASTA 200x100

 MEDIDAS ESPECIALES. CONSULTAR A FÁBRICA.

CLEAF

FENIX NTM®

ALNIC  
CENTER

E EGGER

FINSA  
soluciones en madera

SONAE  
ARAUCO  
Taking wood further

LuxRaff®

MERKACRISTAL®



Verdú®  
HERRAJES PARA MUEBLES







# ENCIMERA PORCELÁNICO

MESINOR  
TABURETES&BARRAS

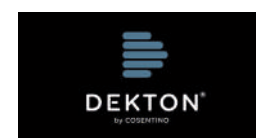
## FIJAS

Armazón y patas NEGRO-BLANCO-ALUMINIO	Medidas	Categoría	120x80	140x90	160x90
	PORCELÁNICO 3*5	Cat.1	999	1080	1165
	PORCELÁNICO 3*5	Cat. 2	1050	1157	1251
	PORCELÁNICO 3*5	Cat. 3	1095	1214	1315
	LAMINAM 12 mm 	Go-G1	1270	1429	1558
	LAMINAM 12 mm 	G2	1420	1626	1781
	ARKLAM 12 mm 	Todas	1058	1420	1564
	SILESTONE 12 mm	G1	1052	1164	1261
	SILESTONE 12 mm	G2	1085	1205	1314
	SILESTONE 12 mm	G3	1108	1238	1349
	SILESTONE 12 mm	G4	1164	1311	1428
	SILESTONE 12 mm	G5	1199	1352	1481
	SILESTONE 12 mm	G6	1273	1452	1596
	DEKTON 8 mm	G0	1107	1231	1339
	DEKTON 8 mm	G1	1169	1316	1433
	DEKTON 8 mm	G2	1219	1384	1513
	DEKTON 8 mm	G3	1280	1463	1604
DEKTON 8 mm	G4	1366	1578	1733	
DEKTON 12 mm	G0	1176	1323	1440	
DEKTON 12 mm	G1	1246	1417	1546	
DEKTON 12 mm	G2	1311	1499	1640	
DEKTON 12 mm	G3	1379	1591	1746	
DEKTON 12 mm	G4	1479	1717	1890	



Armazón y patas PINTURA MUESTRARIO	Medidas	Categoría	120x80	140x90	160x90
	PORCELÁNICO 3*5	Cat.1	1107	1188	1273
	PORCELÁNICO 3*5	Cat. 2	1158	1265	1359
	PORCELÁNICO 3*5	Cat. 3	1203	1322	1423
	LAMINAM 12 mm 	Go-G1	1378	1537	1666
	LAMINAM 12 mm 	G2	1528	1734	1889
	ARKLAM 12 mm 	Todas	1166	1528	1672
	SILESTONE 12 mm	G1	1160	1272	1369
	SILESTONE 12 mm	G2	1193	1313	1422
	SILESTONE 12 mm	G3	1216	1346	1457
	SILESTONE 12 mm	G4	1272	1419	1536
	SILESTONE 12 mm	G5	1307	1460	1589
	SILESTONE 12 mm	G6	1381	1560	1704
	DEKTON 8 mm	G0	1215	1339	1447
	DEKTON 8 mm	G1	1277	1424	1541
	DEKTON 8 mm	G2	1327	1492	1621
	DEKTON 8 mm	G3	1388	1571	1712
DEKTON 8 mm	G4	1474	1686	1841	
DEKTON 12 mm	G0	1284	1431	1548	
DEKTON 12 mm	G1	1354	1525	1654	
DEKTON 12 mm	G2	1419	1607	1748	
DEKTON 12 mm	G3	1487	1699	1854	
DEKTON 12 mm	G4	1587	1825	1998	

**¡IMPORTANTE!**

 **MEDIDAS ESPECIALES**  
DESDE 80x80 HASTA 200x100

 **MEDIDAS ESPECIALES**  
CONSULTAR A FÁBRICA.

**ACABADO SUEDE EN DEKTON Y SILESTONE INCREMENTA 5%**

OPCIONES	
Canto Chafán	160

# MESA PLANK PIE DOBLE

## PIE DOBLE CON ENCIMERA

- Laminado 4 cm

## ESTRUCTURA

- Armazón metálico.

## PATAS

- Patas metálicas.



Mesa Plank Pie Doble altura 90, encimera Olmo Sabi. Taburete Galo color Turtle Dove 802.



**ESTRUCTURA**

Mesa Plank pie doble, realizada en estructura metálica de 20 con pie metálico de 60x20 con niveladores.  
Se fabrica desde altura 75 hasta 90 cm.



**ENCIMERA**

Encimera de 4 cm de espesor, canto en su color en las encimeras disponibles, resto en canto efecto marino madera.

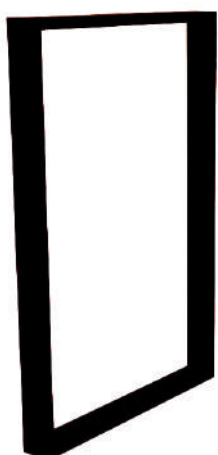

PIE 60x20



**ENCIMERAS 4CM DISPONIBLES**

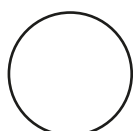

BLANCO

Sonae Pure  
White B4402

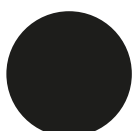

NEGRO

Finsa Negro  
S.3 231



ROBLE  
ANTIC

Egger H-3331



ROBLE  
AMAZONA

Finsa Atlas 6AS



MÁRMOL  
BLANCO

Finsa Teide  
72Y



MÁRMOL  
NEGRO

Finsa Teide  
2AE 1 AT



ROBLE  
DAFNE

Finsa Atlas  
91Y

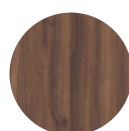

NOGAL  
VALENTINA

Finsa Mesura  
1AS



HALIFAX  
MEDIO

Egger Halifax  
Natural  
H-1180ST-37



\*Resto de colores con el canto efecto marino madera  
SIN INCREMENTO.



# Técnico

## MESA PLANK PIE DOBLE

MEDIDA MÍNIMA 70x35  
MEDIDA MÁXIMA 160x100

MEDIDAS PATAS H-90

MEDIDAS PATAS H-75

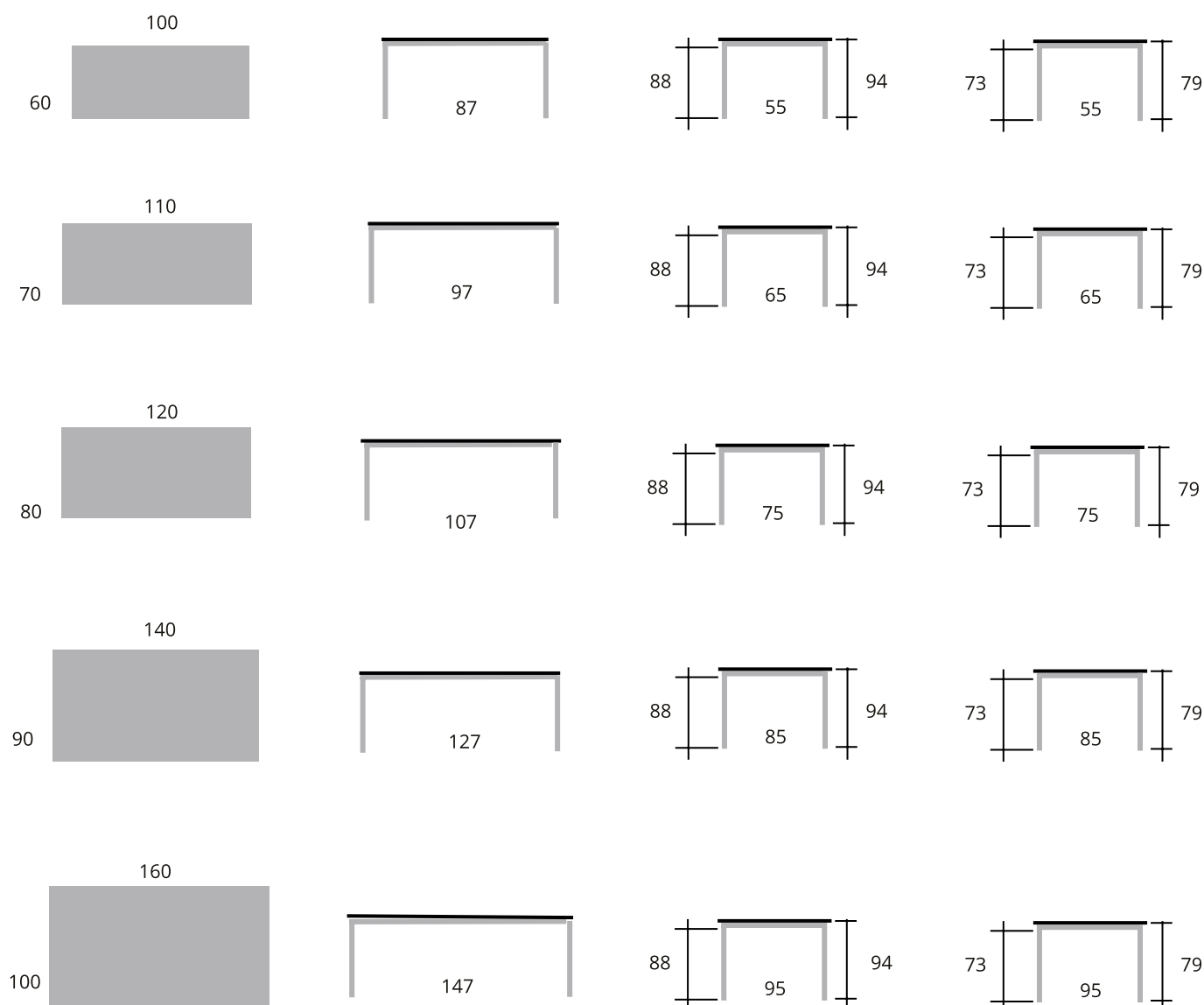

**MEDIDAS ESPECIALES EN LA MESA PLANK PIE DOBLE  
DESDE 70x35 HASTA 160X100**

**ALTURA BARRA PLANK PIE DOBLE SÓLO ALTURA DE 94**

**ALTURA MESA PLANK PIE DOBLE SÓLO ALTURA DE 79**

## DESPIECE



Encimera  
• Laminado 4 cm



Pie tubo rectangular 6x2 cm  
• Metálico

# PIE DOBLE CON ENCIMERA DE 4 cm Altura 90 cm

## FIJAS

Pies NEGRO-BLANCO-ALUMINIO					
Medidas	Laminado Cat. 1 Blanco, Negro, Roble Amazona, Mármol Blanco, Mármol Negro, Roble Antic, Roble Aurora, Roble Dafne, Nogal Valentina CANTO A JUEGO	Laminado Cat. 1  CANTO EFECTO MARINO MADERA	Laminado Cat. 2 Halifax Medio  CANTO A JUEGO	Laminado Cat. 2  CANTO EFECTO MARINO MADERA	Laminado Cat. 3  CANTO EFECTO MARINO MADERA
100x60	600	600	643	643	765
110x70	666	666	722	722	879
120x80	745	745	814	814	1008
140x90	883	883	971	971	1226
160x100	1131	1131	1242	1242	1566

Pies PINTURA MUESTRARIO					
Medidas	Laminado Cat. 1 Blanco, Negro, Roble Amazona, Mármol Blanco, Mármol Negro, Roble Antic, Roble Aurora, Roble Dafne, Nogal Valentina CANTO A JUEGO	Laminado Cat. 1  CANTO EFECTO MARINO MADERA	Laminado Cat. 2 Halifax Medio  CANTO A JUEGO	Laminado Cat. 2  CANTO EFECTO MARINO MADERA	Laminado Cat. 3  CANTO EFECTO MARINO MADERA
100x60	610	610	653	653	775
110x70	676	676	732	732	889
120x80	755	755	824	824	1018
140x90	893	893	981	981	1236
160x100	1141	1141	1252	1252	1576

**\*\* ENCIMERA EN CRISTAL O PORCELÁNICO CONSULTAR A FÁBRICA \*\***



### ¡IMPORTANTE!

MEDIDAS ESPECIALES DESDE 70x35 HASTA 160x100

ALTURA ESPECIAL PIE DESDE 75 HASTA 90

MEDIDAS ESPECIALES. CONSULTAR A FÁBRICA.



# PIE DOBLE CON ENCIMERA DE 4 cm Altura 75 cm

## FIJAS

Pies NEGRO-BLANCO-ALUMINIO					
Medidas	Laminado Cat. 1 Blanco, Negro, Roble Amazona, Mármol Blanco, Mármol Negro, Roble Antic, Roble Aurora, Roble Dafne, Nogal Valentina CANTO A JUEGO	Laminado Cat. 1  CANTO EFECTO MARINO MADERA	Laminado Cat. 2 Halifax Medio  CANTO A JUEGO	Laminado Cat. 2  CANTO EFECTO MARINO MADERA	Laminado Cat. 3  CANTO EFECTO MARINO MADERA
100x60	577	577	621	621	743
110x70	644	644	700	700	857
120x80	723	723	792	792	986
140x90	861	861	949	949	1204
160x100	1109	1109	1220	1220	1544

Pies PINTURA MUESTRARIO					
Medidas	Laminado Cat. 1 Blanco, Negro, Roble Amazona, Mármol Blanco, Mármol Negro, Roble Antic, Roble Aurora, Roble Dafne, Nogal Valentina CANTO A JUEGO	Laminado Cat. 1  CANTO EFECTO MARINO MADERA	Laminado Cat. 2 Halifax Medio  CANTO A JUEGO	Laminado Cat. 2  CANTO EFECTO MARINO MADERA	Laminado Cat. 3  CANTO EFECTO MARINO MADERA
100x60	587	587	631	631	753
110x70	654	654	710	710	867
120x80	733	733	802	802	996
140x90	871	871	959	959	1214
160x100	1119	1119	1230	1230	1554

**\*\*ENCIMERA EN CRISTAL O PORCELÁNICO CONSULTAR A FÁBRICA\*\***



### ¡IMPORTANTE!

MEDIDAS ESPECIALES DESDE 70x35 HASTA 160x100

ALTURA ESPECIAL PIE DESDE 75 HASTA 90

MEDIDAS ESPECIALES. CONSULTAR A FÁBRICA.





# MESA PLANK PATAS. Fija

## ENCIMERA

- Laminado 3 categorías.
- Haya y Roble. (Barniz mate) New!
- Cristal Brillo, Mate New! y Antirayas.
- Porcelánico 3 mm + Cristal 5 mm.
- Arklam 12 mm New!
- Laminam 12 mm New!
- Silestone 12 mm
- Dekton 8 mm y Dekton 12 mm

## ESTRUCTURA

- Armazón metálico.

## PATAS

- Patas metálicas.
- Patas madera de Haya o Roble.



Mesa Plank Fija Salida **Lateral** Con Diferentes Alturas







Mesa Plank Fija Salida **Frontal** Con Diferentes Alturas



Mesa Plank Patas Fija altura 90, encimera Dekton Aura. Taburete Gea Haya Natural 01.

## MESA PLANK PATAS FIJA

MEDIDA MÍNIMA 70x35  
MEDIDA MÁXIMA 200x100

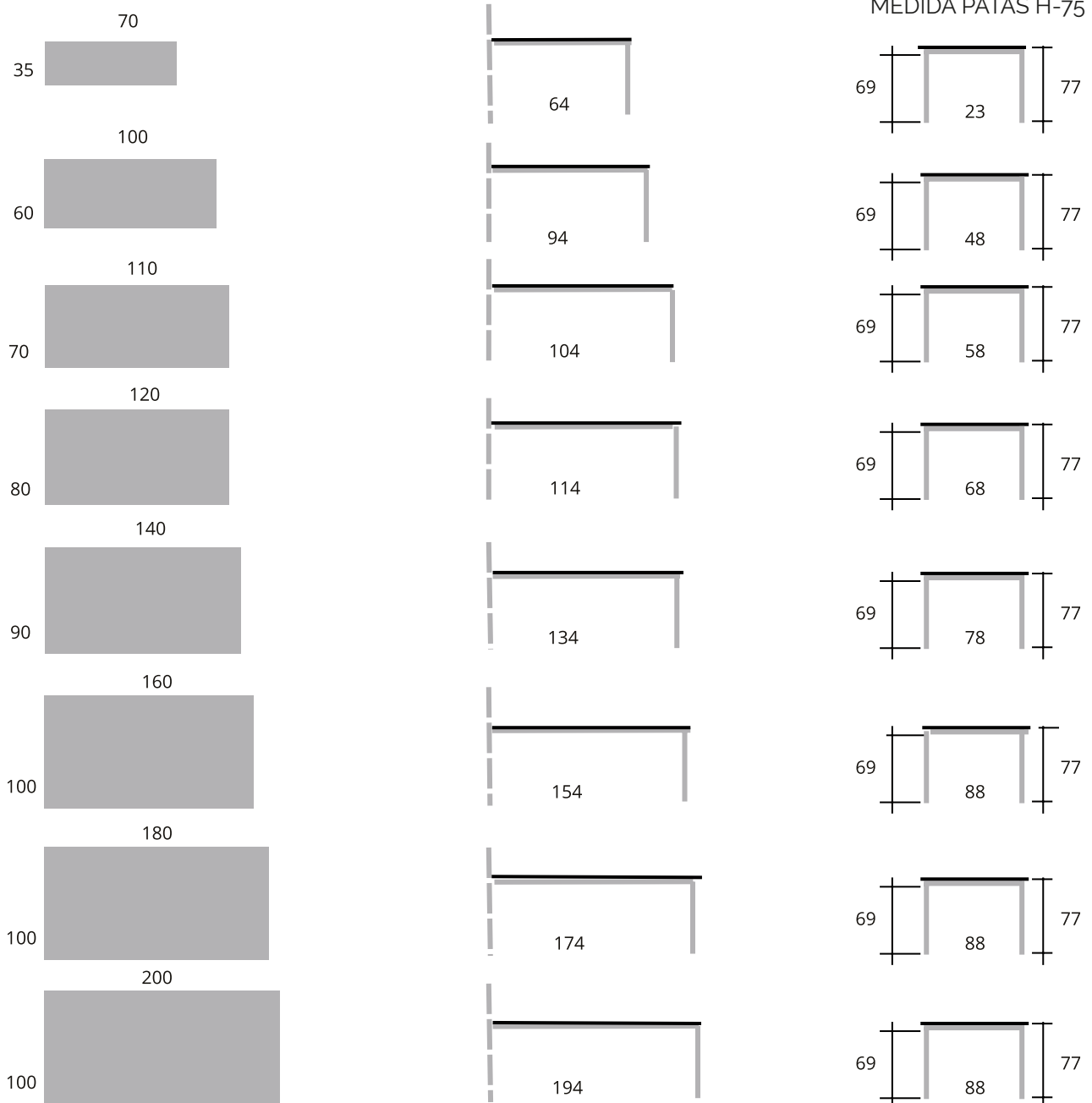

### MEDIDAS ESPECIALES EN LA MESA PLANK PATAS FIJA DESDE 70X35 HASTA 200X100

ALTURA ESPECIAL DE MESA DESDE 77 HASTA 112 (Sólo PATAS METÁLICAS)	Medidas Pata	80	85	90	95	100	105	110
	Altura Mesa	82	87	92	97	102	107	112
	Hueco Interior	74	79	84	89	94	99	104

### ENCIMERA EMBUTIDA



### DESPIECE

- Encimera
  - Laminado
  - Cristal
  - Porcelánico
- Patas tubo cuadrado de 5x5 cm.
  - Metálicas
  - Madera de Haya o Roble sólo altura de 75 cm
- Armazón de 6 cm
  - Metálico

# ENCIMERA LAMINADO

## FIJAS

Armazón y patas NEGRO-BLANCO-ALUMINIO					HYDROBARNIZ MESINOR	HYDROBARNIZ MESINOR
Medidas	Encimera Embutida	Laminado cat.1	Laminado cat.2	Laminado cat.3	Haya Barniz Colores madera <sup>New!</sup>	Roble Barniz <sup>New!</sup>
100x60	383	414	433	502	525	552
110x70	395	429	454	537	546	576
120x80	409	445	474	574	569	602
140x90	424	462	498	616	594	630
160x100	504	549	601	769	713	760
180x100	520	569	627	815	741	791
200x100	537	587	651	856	767	821

Armazón y patas PINTURA MUESTRARIO					HYDROBARNIZ MESINOR	HYDROBARNIZ MESINOR
Medidas	Encimera Embutida	Laminado cat.1	Laminado cat.2	Laminado cat.3	Haya Barniz Colores madera <sup>New!</sup>	Roble Barniz <sup>New!</sup>
100x60	475	506	525	594	617	644
110x70	487	521	546	629	638	668
120x80	501	537	566	666	661	694
140x90	516	554	590	708	686	722
160x100	596	641	693	861	805	852
180x100	612	661	719	907	833	883
200x100	629	679	743	948	859	913

OPCIONES PATAS	
Patatas de Haya	44
Patatas de Roble	110



# ENCIMERA CRISTAL

## FIJAS

Armazón y patas NEGRO-BLANCO-ALUMINIO			
Medidas	Brillo Todos los Colores Blanco óptico	Mate <sup>New!</sup> Todos los Colores Blanco óptico	Antirrayas <sup>New!</sup> Todos los Colores Blanco óptico
100x60	481	540	592
110x70	503	576	660
120x80	526	611	724
140x90	562	666	840

Armazón y patas PINTURA MUESTRARIO			
Medidas	Brillo Todos los Colores Blanco óptico	Mate <sup>New!</sup> Todos los Colores Blanco óptico	Antirrayas <sup>New!</sup> Todos los Colores Blanco óptico
100x60	573	632	684
110x70	595	668	752
120x80	618	703	816
140x90	654	758	932

### ¡IMPORTANTE!

-  MEDIDAS ESPECIALES DESDE 70x35 HASTA 200x100
-  ALTURA ESPECIAL PATAS DESDE 75 HASTA 110
-  MEDIDAS ESPECIALES. CONSULTAR A FÁBRICA.



# MESA PLANK PATAS. Extensible

## ENCIMERA

- Laminado 3 categorías.
- Haya y Roble. (Barniz mate) New!
- Cristal Brillo, Mate New! y Antirayas.
- Porcelánico 3 mm + Cristal 5 mm.
- Arklam 12 mm New!
- Laminam 12 mm New!
- Silestone 12 mm
- Dekton 8 mm y Dekton 12 mm

## ESTRUCTURA

- Armazón metálico.

## EXTENSIBLES

- Laminado a juego de la encimera.
- Apertura libro.

## PATAS

- Patas metálicas.
- Patas madera de Haya o Roble.

MESA PLANK PATAS EXTENSIBLE SALIDA **LATERAL** CON DIFERENTES ALTURAS



Mesa Plank Patas Extensible altura 100, encimera Roble Natural 01. Taburete Sun.

**MESA PLANK PATAS EXTENSIBLE LATERAL O FRONTAL  
CON DIFERENTES ALTURAS**



**MESA PLANK PATAS EXTENSIBLE  
LATERAL O FRONTAL**



## MESA PLANK PATAS EXTENSIBLE LATERAL

MEDIDA MÍNIMA 100x60 / MEDIDA MÁXIMA 160x90

MEDIDA PATAS H-90

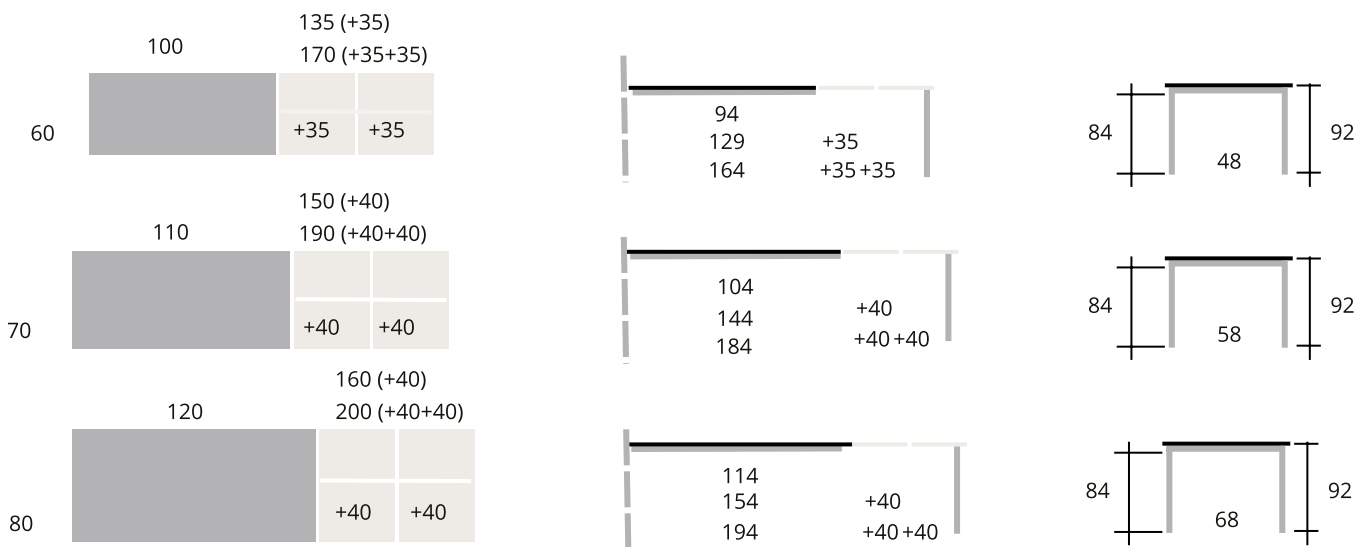

## MESA PLANK PATAS EXTENSIBLE FRONTAL

MEDIDA MÍNIMA 90x45 / MEDIDA MÁXIMA 120x50

MEDIDA PATAS H-90

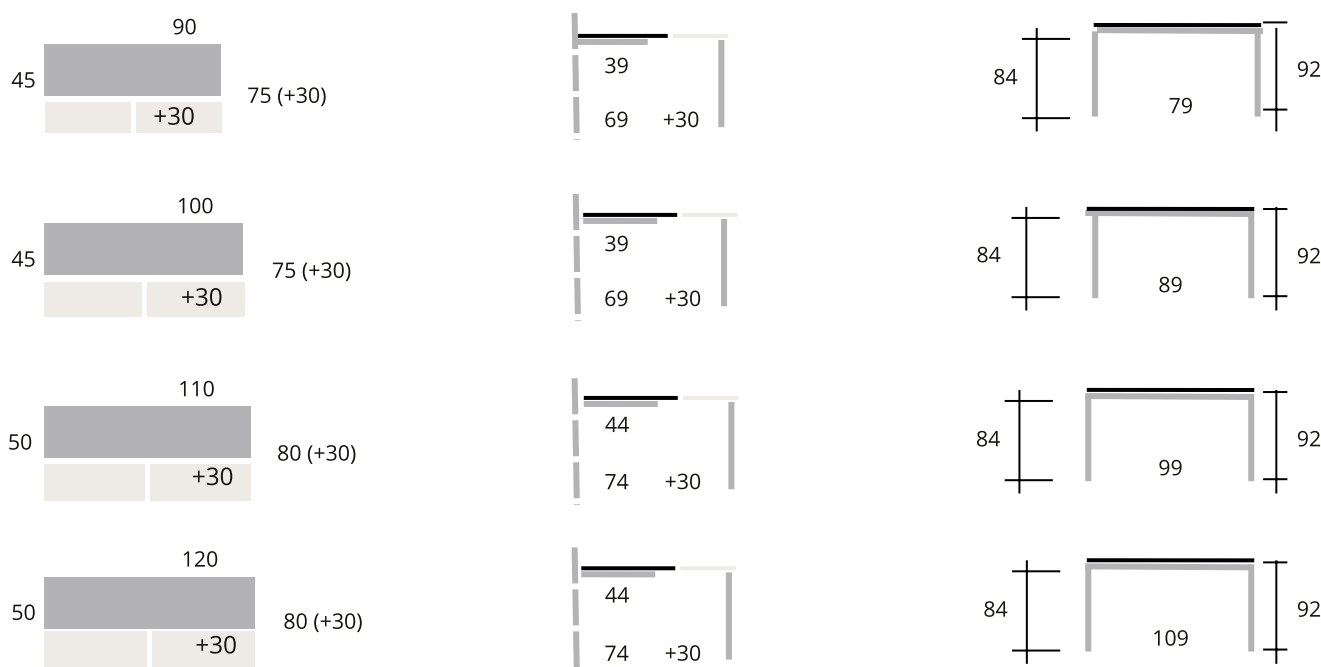

**NO SE FABRICAN MEDIDAS ESPECIALES EN LA MESA PLANK PATAS EXTENSIBLE**

ALTURA ESPECIAL DE MESA DESDE 77 HASTA 112 (Sólo PATAS METÁLICAS)	Medidas Pata	80	85	90	95	100	105	110
	Altura Mesa	82	87	92	97	102	107	112
	Hueco Interior	74	79	84	89	94	99	104

### DESPIECE

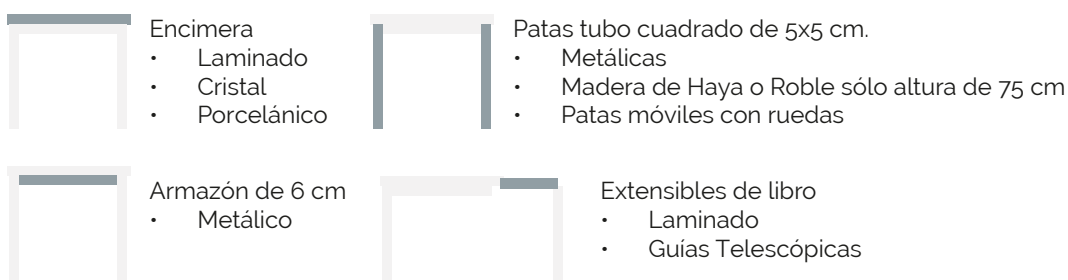

## ENCIMERA LAMINADO

### EXTENSIBLE LATERAL

Armazón y patas NEGRO-BLANCO-ALUMINIO				HYDROBARNIZ MESINOR	HYDROBARNIZ MESINOR
Medidas	Laminado cat.1	Laminado cat.2	Laminado cat.3	Haya Barniz Colores madera	Roble Barniz
100x60	743	779	871	886	903
110x70	773	819	938	928	950
120x80	789	842	983	954	980
140x90	818	880	1045	994	1025
160x90	857	921	1095	1039	1071

Armazón y patas PINTURA MUESTRARIO				HYDROBARNIZ MESINOR	HYDROBARNIZ MESINOR
Medidas	Laminado cat.1	Laminado cat.2	Laminado cat.3	Haya Barniz Colores madera	Roble Barniz
100x60	871	907	999	1014	1031
110x70	901	947	1066	1056	1078
120x80	917	970	1111	1082	1108
140x90	946	1008	1173	1122	1153
160x90	985	1049	1223	1167	1199

OPCIONES PATAS	
Patatas de Haya	44
Patatas de Roble	110

## ENCIMERA CRISTAL

### EXTENSIBLE LATERAL

Armazón y patas NEGRO-BLANCO-ALUMINIO			
Medidas	Brillo Todos los Colores Blanco óptico	Mate Todos los Colores Blanco óptico	Antirrayas Todos los Colores Blanco óptico
100x60	806	860	920
110x70	844	911	1003
120x80	868	947	1068
140x90	915	1013	1196

Armazón y patas PINTURA MUESTRARIO			
Medidas	Brillo Todos los Colores Blanco óptico	Mate Todos los Colores Blanco óptico	Antirrayas Todos los Colores Blanco óptico
100x60	934	988	1048
110x70	972	1039	1131
120x80	996	1075	1196
140x90	1043	1141	1324

**\*\*ENCIMERA EN PORCELÁNICO CONSULTAR A FÁBRICA\*\***

#### ¡IMPORTANTE!

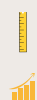

ALTURA ESPECIAL PATAS DESDE 75 HASTA 110

MEDIDAS ESPECIALES. CONSULTAR A FÁBRICA.

CLEAF

FENIX NTM®

ALNIC  
CENTER

E EGGER

FINSA  
soluciones en madera

SONAE  
ARAUCO  
Taking wood further

LuxRaff®

MERKACRISTAL®

Verdú®  
HERRAJES PARA MUEBLES

## ENCIMERA LAMINADO

### EXTENSIBLE FRONTAL

Armazón y patas NEGRO-BLANCO-ALUMINIO				HYDROBARNIZ MESINOR	HYDROBARNIZ MESINOR
Medidas	Laminado cat.1	Laminado cat.2	Laminado cat.3	Haya Barniz Colores madera	Roble Barniz
90x45	626	650	709	754	765
100x45	635	661	727	766	779
110x50	656	686	764	793	808
120x50	665	698	782	806	822

Armazón y patas PINTURA MUESTRARIO				HYDROBARNIZ MESINOR	HYDROBARNIZ MESINOR
Medidas	Laminado cat.1	Laminado cat.2	Laminado cat.3	Haya Barniz Colores madera	Roble Barniz
90x45	754	778	837	882	893
100x45	763	789	855	894	907
110x50	784	814	892	921	936
120x50	793	826	910	934	950

OPCIONES PATAS	
Patatas de Haya	44
Patatas de Roble	110

## ENCIMERA CRISTAL

### EXTENSIBLE FRONTAL

Armazón y patas NEGRO-BLANCO-ALUMINIO			
Medidas	Brillo Todos los Colores Blanco óptico	Mate <sup>New!</sup> Todos los Colores Blanco óptico	Antirayas <sup>New!</sup> Todos los Colores Blanco óptico
90x45	686	733	759
100x45	698	738	783
110x50	723	781	834
120x50	736	797	860

Armazón y patas PINTURA MUESTRARIO			
Medidas	Brillo Todos los Colores Blanco óptico	Mate <sup>New!</sup> Todos los Colores Blanco óptico	Antirayas <sup>New!</sup> Todos los Colores Blanco óptico
90x45	814	861	887
100x45	826	866	911
110x50	851	909	962
120x50	864	925	988

**\*\*ENCIMERA EN PORCELÁNICO CONSULTAR A FÁBRICA\*\***

#### ¡IMPORTANTE!



ALTURA ESPECIAL PATAS DESDE 75 HASTA 110



MEDIDAS ESPECIALES. CONSULTAR A FÁBRICA.

CLEAF

FENIX <sup>NTM</sup>

ALNIC  
CENTER

EGGER

FINSA  
soluciones en madera

SONAE  
ARAUCO  
Taking wood further

LuxRaff®

MERKACRISTAL®

Verdú®  
HERRAJES PARA MUEBLES





# MESA PLANK PIE

## PIE SIN ENCIMERA

### PIE

- Pie metálico.

## PIE CON ENCIMERA

### ENCIMERA

- Laminado 3 categorías.
- Cristal Brillo, Mate New! y Antirayas.
- Porcelánico 3 mm + Cristal 5 mm.
- Arklam 12 mm New!
- Laminam 12 mm New!
- Silestone 12 mm
- Dekton 8 mm y Dekton 12 mm.

## PIE

- Pie metálico.

## PIE ADAPTABLE CON DIFERENTES ALTURAS



**PIE ADAPTABLE CON DIFERENTES POSICIONES Y ALTURAS**



Mesa Plank Pie Giratorio a 90° altura 100, encimera Mármol Blanco de 4 cm.



# MESA PLANK PIE GIRATORIO 90°

## PIE CON ENCIMERA

### ENCIMERA

- Laminado 4 cm

### PIE

- Pie metálico

## PREMIUM SESTANTE 90°



**Mesa Plank Pie Premium Sestante 90°** es un novedoso sistema totalmente funcional que permite correr y girar la encimera sobre un módulo de cocina.

Siempre que se desee o sea necesario, es posible girar y rotar más de 90° y convertir la mesa Plank en una encimera versátil. También se puede aplicar en salas de estar y entornos de oficina.

### Vídeo Sistema Premium Sestante 90°

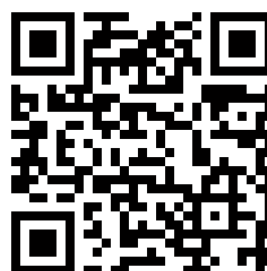

**ALTURA REGULABLE**  
Mínimo 800 Máximo 960

**MEDIDAS DISPONIBLES**  
100x60 · 110x70 · 120x80 · 140x90 · A medida

Tarifa y condiciones. Consultar a fábrica

### ENCIMERAS 4CM DISPONIBLES

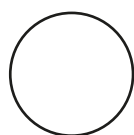

BLANCO

Sonae Pure  
White B4402



NEGRO

Finsa Negro  
S.3 231



ROBLE  
ANTIC

Egger H-3331



ROBLE  
AMAZONA

Finsa Atlas 6AS

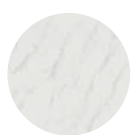

MÁRMOL  
BLANCO

Finsa Teide  
72Y



MÁRMOL  
NEGRO

Finsa Teide  
2AE 1 AT

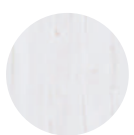

ROBLE  
DAFNE

Finsa Atlas  
91Y

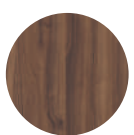

NOGAL  
VALENTINA

Finsa Mesura  
1AS



HALIFAX  
MEDIO

Egger Halifax  
Natural  
H-1180ST-37



\*Resto de colores con el canto efecto marino madera SIN INCREMENTO.



FENIX NTM®

ALVIC  
CENTER

EGGER



LuxRaff®

Verdú®  
HERRAJES PARA MUEBLES

## MESA PLANK PIE

MEDIDA MÍNIMA: 29

MEDIDA MÁXIMA: 99

MEDIDA MÁXIMA largo: 160

MESA PLANK PIE CON ENCIMERA

MEDIDAS PATAS H-90

MESA PLANK PIE

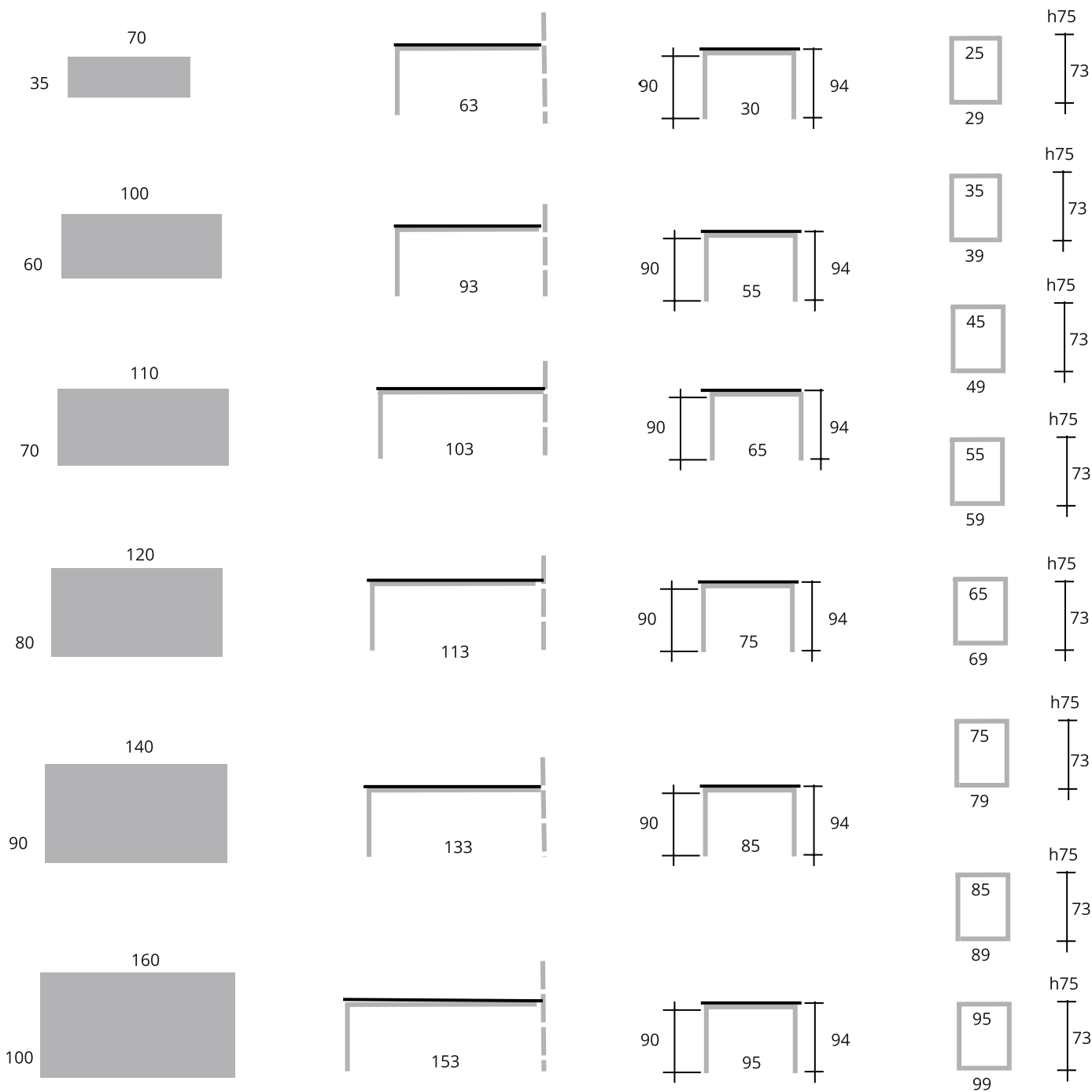

### MEDIDAS ESPECIALES EN LA MESA PLANK PIE DESDE 70x35 HASTA 160x100

	Medida Pie	80	85	90	95	100	105	110
ALTURA ESPECIAL DE MESA DESDE 79 HASTA 114	Altura Mesa	84	89	94	99	104	109	114
	Hueco Interior	80	85	90	95	100	105	110

### DESPIECE



Encimera  
• Laminado 4 cm



Pie tubo rectangular de 6x2 cm  
• Metálico

## PIE SIN ENCIMERA

### FIJAS

Pie NEGRO-BLANCO-ALUMINIO	
Medidas	Sin encimera
Ancho 29 cm	230
Ancho 39 cm	233
Ancho 49 cm	236
Ancho 59 cm	238
Ancho 69 cm	241
Ancho 79 cm	244
Ancho 89 cm	247
Ancho 99 cm	250

Pie PINTURA MUESTRARIO	
Medidas	Sin encimera
Ancho 29 cm	278
Ancho 39 cm	281
Ancho 49 cm	284
Ancho 59 cm	286
Ancho 69 cm	289
Ancho 79 cm	292
Ancho 89 cm	295
Ancho 99 cm	298



**MESINOR.com**

mesas y sillas

## PIE CON ENCIMERA DE 4 cm

### FIJAS

Pies NEGRO-BLANCO-ALUMINIO					
Medidas	Laminado Cat. 1 Blanco, Negro, Roble Amazona, Mármol Blanco, Mármol Negro, Roble Antic, Roble Aurora, Roble Dafne, Nogal Valentina  CANTO A JUEGO	Laminado Cat. 1  CANTO EFECTO MARINO MADERA	Laminado Cat. 2 Halifax Medio  CANTO A JUEGO	Laminado Cat. 2  CANTO EFECTO MARINO MADERA	Laminado Cat. 3  CANTO EFECTO MARINO MADERA
100x60	415	415	459	459	580
110x70	438	438	494	494	650
120x80	458	458	527	527	721
140x90	491	491	579	579	834
160x100	536	536	647	647	972

Pies PINTURA MUESTRARIO					
Medidas	Laminado Cat. 1 Blanco, Negro, Roble Amazona, Mármol Blanco, Mármol Negro, Roble Antic, Roble Aurora, Roble Dafne, Nogal Valentina  CANTO A JUEGO	Laminado Cat. 1  CANTO EFECTO MARINO MADERA	Laminado Cat. 2 Halifax Medio  CANTO A JUEGO	Laminado Cat. 2  CANTO EFECTO MARINO MADERA	Laminado Cat. 3  CANTO EFECTO MARINO MADERA
100x60	463	463	507	507	628
110x70	486	486	542	542	698
120x80	506	506	575	575	769
140x90	539	539	627	627	882
160x100	584	584	695	695	1020

**\*\* ENCIMERA EN CRISTAL O PORCELÁNICO CONSULTAR A FÁBRICA \*\***



**¡IMPORTANTE!**  
MEDIDAS ESPECIALES DESDE 70x35 HASTA 160x100

ALTURA ESPECIAL PIE DESDE 75 HASTA 110

MEDIDAS ESPECIALES. CONSULTAR A FÁBRICA.



# MESA FOLD PLEGABLE

## ENCIMERA PLEGABLE

### ENCIMERA

- Laminado 3 categorías
- Haya o Roble. (Barniz mate) 



## MESA FOLD PLEGABLE CON 4 MEDIDAS



ESCUADRA PISTÓN NEGRA



ESCUADRA INOX

## Técnico

### MESA FOLD PEGABLE

MEDIDA MÍNIMA 80X40 / MEDIDA MÁXIMA 110X60

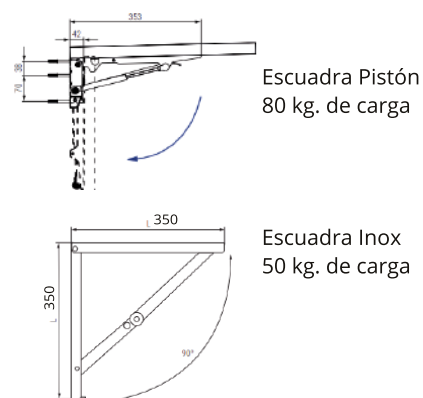
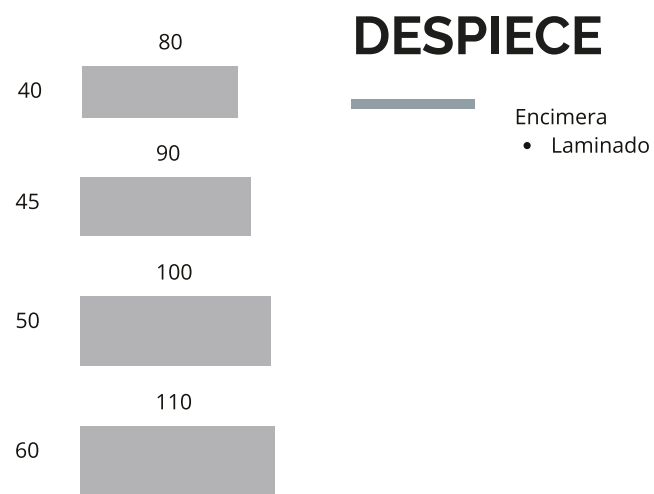



# MESA FOLD PLEGABLE

## FIJAS

Abatible de Pared. Herraje pistón				HYDROBARNIZ MESINOR	HYDROBARNIZ MESINOR
Medidas	Laminado cat.1	Laminado cat.2	Laminado cat.3	Haya Barniz Colores madera	Roble Barniz
80x40	256	280	310	368	373
90x45	260	286	325	376	383
100x50	265	294	341	385	394
110x60	273	307	370	399	410

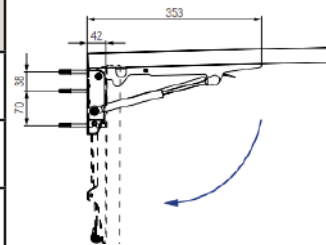

Abatible de Pared. Herraje Inox				HYDROBARNIZ MESINOR	HYDROBARNIZ MESINOR
Medidas	Laminado cat.1	Laminado cat.2	Laminado cat.3	Haya Barniz Colores madera	Roble Barniz
80x40	231	243	273	328	333
90x45	236	251	289	336	343
100x50	241	259	306	345	353
110x60	249	272	334	359	370

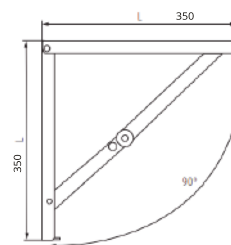

¡IMPORTANTE!



MEDIDAS ESPECIALES. CONSULTAR A FÁBRICA.

CLEAF

FENIX NTM®

ALNIC  
CENTER

EGGER

FINSA  
soluciones en madera

SONAE  
ARAUCO  
Taking wood further

LuxRaff®

MERKACRISTAL®

Verdú®  
HERRAJES PARA MUEBLES

# BARRAS A MEDIDA

- FABRICAMOS A MEDIDA



Tarifa y condiciones.  
Consultar a fábrica

## TRABAJAMOS A TU MEDIDA



# TÉCNICO BARRAS

## ENCIMERAS

### Encimera Laminado



### Encimera Porcelánico 3 mm + Cristal 5 mm

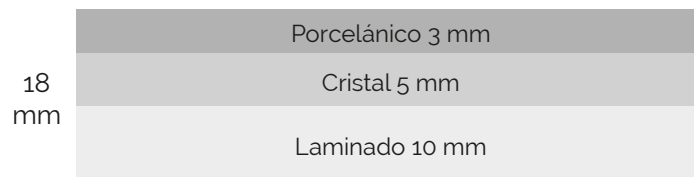

### Encimera Contrachapado de Haya o Roble



### Encimera Porcelánico 8 mm

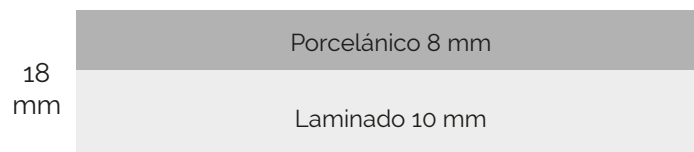

### Encimera Cristal

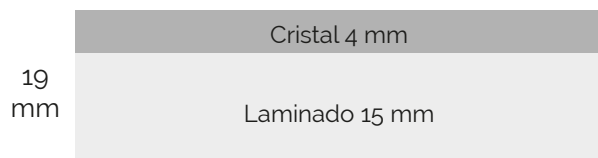

### Encimera Porcelánico 12 mm

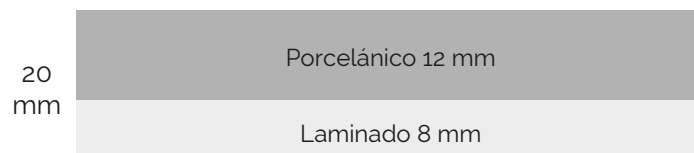

### Encimera Cristal Antirayas



## Cantos disponibles

### ENCIMERA CANTO RECTO

- Laminados (DE SERIE)
- Cristales (DE SERIE)
- Contrachapado (DE SERIE)



### ENCIMERA VOLADA

- Porcelánicos (DE SERIE)



### ENCIMERA CANTO CHAFLÁN

- Cristales (OPCIONAL)
- Porcelánicos de 8 mm (OPCIONAL)



## CANTO COLOR SEGÚN ACABADO

 ENCIMERA LAMINADO EN SU COLOR (efecto testa)

 ENCIMERA CRISTAL Y PORCELÁNICO EN COLOR DEL ARMAZÓN

### EFEECTO TESTA

 Canto en veta y contraveta

## PATAS

 PATA METAL ALTURA ESTÁNDAR 75 CM

 PATA METAL ALTURA ESPECIAL DESDE 76 HASTA 110 (Cortamos a medida)

- PATA DE 90
- PATA DE 100
- PATA DE 110

 PATA MADERA ALTURA ESTÁNDAR 75 CM

- MADERA HAYA
- MADERA ROBLE

**MEDIDAS ESPECIALES**  
Consultar modelo.

# BARNIZ ENCIMERAS



# BARNIZ ENCIMERAS



**HYDROBARNIZ**  
**MESINOR**  
COATINGS

Producto 100% al agua con excelentes prestaciones.

Este producto optimiza la calidad del aire en ambientes de interior, es respetuoso con el medioambiente y con la salud de las personas.

Producto de alta calidad, que aporta protección, belleza y naturalidad a la madera.

Excelentes resistencias físicas-químicas: cambios térmicos, dureza, etc.



## CUMPLE ISO 22196

Actividad antibacteriana de superficies plásticas y superficies no porosas.



## CUMPLE UNE 15457

Método de laboratorio para el ensayo de la eficacia de los conservantes de la película de un recubrimiento frente a los hongos



## CERTIFICADO DE EMISIONES AL AIRE A+

Producto con ninguna o mínimas emisiones de COVs.

# TAPICERÍA CARCASAS

MESINOR

## TAPICERÍA CARCASAS

La *Tapicería de Carcasas by Mesinor*

Cada carcasa se corta pieza a pieza y es cosida por manos expertas con un hilo reforzado dotando durabilidad a su acabado.

El interior se compone de piezas de espuma y refuerzos que aportan resistencia y comodidad a tu silla o taburete.

Un proceso local y amable con el medio ambiente que aporta valor al territorio y fija población.

**Busca nuestra etiqueta sello de calidad Mesinor.**

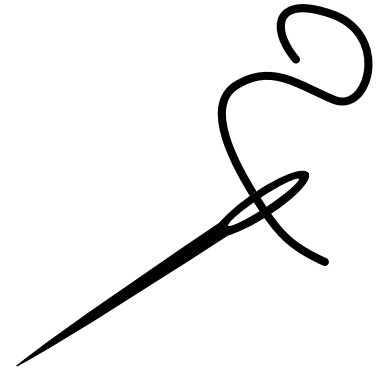

## TAPICERÍA BICOLOR

La *Tapicería Bicolor by Mesinor*

Dale un toque de distinción a tus proyectos, eligiendo diferentes telas para el respaldo o el asiento, acertarás combinando cualquiera de nuestras telas de nuestro muestrario.

**Fabricamos a tu medida .**

**Busca nuestra etiqueta sello de calidad Mesinor.**



## CARCASA F40 y F20

La *Carcasa F40 y F20 by Mesinor*

**F40 y F20** son una carcasa tapizada con un doble acolchado, cosido original y refuerzo. El mejor diseño y comodidad que podrás encontrar.

**Fabricamos a tu medida** y puedes elegir entre nuestras carcasas F40 o F20 en doble tapizado también.

**Busca nuestra etiqueta sello de calidad Mesinor.**





**ACABADOS**

**FINITIONS**



# ACABADOS TELAS VINILOS

MESINOR  
TABURETES&BARRAS

Finitions.Tissus

Para pedidos recomendamos utilizar los muestrarios físicos.  
Las fotos de acabados son una representación de los mismos.

# TAPIZADO 1

## VALENCIA MESINOR

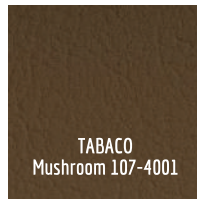
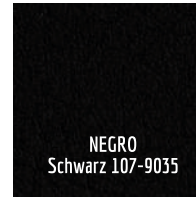
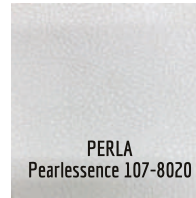
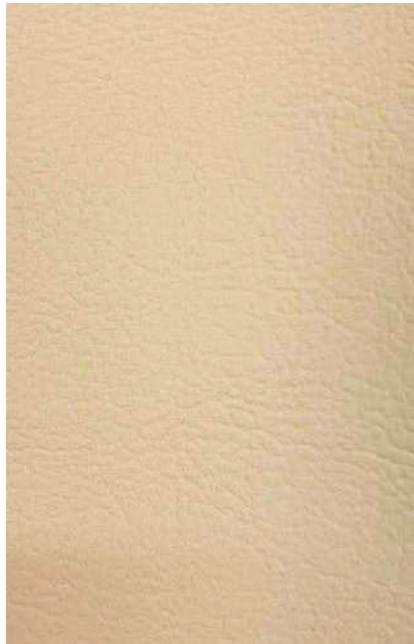

## VALENCIA MUESTRARIO COMPLETO

Tienes la posibilidad de elegir entre **TODO EL MUESTRARIO DE LA GAMA VALENCIA** de SPRADLING.

CONSULTAR A FÁBRICA

**SPRADLING®**

## MICHIGAN MESINOR



## MICHIGAN MUESTRARIO COMPLETO

Tienes la posibilidad de elegir entre **TODO EL MUESTRARIO DE LA GAMA MICHIGAN** de DYNACTIV-160.

CONSULTAR A FÁBRICA



Finitions.Tissus

Para pedidos recomendamos utilizar los muestrarios físicos.  
Las fotos de acabados son una representación de los mismos.

## TAPIZADO 2

### WINSTON MESINOR



### WINSTON MUESTRARIO COMPLETO

Tienes la posibilidad de elegir entre TODO EL MUESTRARIO DE LA GAMA WINSTON de COTTING GROUP.



CONSULTAR A FÁBRICA

### ABAKA MESINOR



### ABAKA MUESTRARIO COMPLETO

Tienes la posibilidad de elegir entre TODO EL MUESTRARIO DE LA GAMA ABAKA de COTTING GROUP.



CONSULTAR A FÁBRICA

### SILVERTEX MESINOR



### HITCH MESINOR



### SILVERTEX Y HITCH MUESTRARIO COMPLETO

Tienes la posibilidad de elegir entre TODO EL MUESTRARIO DE LA GAMA SILVETEX Y HITCH de SPRADLING

CONSULTAR A FÁBRICA



Finitions.Tissus

Para pedidos recomendamos utilizar los muestrarios físicos.  
Las fotos de acabados son una representación de los mismos.

## TAPIZADO 2

### CRYSTAL MESINOR

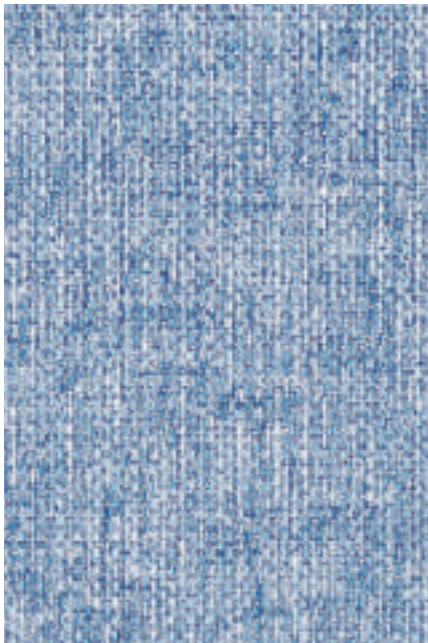

Tratamiento anti manchas



Easy-Clean

### CRYSTAL MUESTRARIO COMPLETO

Tienes la posibilidad de elegir entre TODO EL MUESTRARIO DE LA GAMA CRYSTAL de Exit Fabrics.

exit  
fabrics.

Upholstery  
for all needs

CONSULTAR A FÁBRICA

### MYSTIC MESINOR



Tratamiento anti manchas

aqua  
clean  
TECHNOLOGY

### MYSTIC MUESTRARIO COMPLETO

Tienes la posibilidad de elegir entre TODO EL MUESTRARIO DE LA GAMA MYSTIC de Aqua Clean

aquaclean<sup>®</sup>

telas para vivir

CONSULTAR A FÁBRICA

# ACABADOS TELAS

MESINOR  
TABURETES&BARRAS

Finitions.Tissus

Para pedidos recomendamos utilizar los muestrarios físicos.  
Las fotos de acabados son una representación de los mismos.



**COLECCIONES**  
**MESINOR**

## SPRADLING®



AVANTGARDE



BELUGA



CHRONOS



DIAMANTE



DOLCE (PU)



DOLCE C5 (PU)



ENCORE



FAILLE



FINESSE



HORIZON



LIENZO



LINETEX



MAGLIA



MAGLIA C5

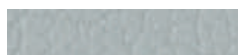

MARLIN



MOSAIQUE

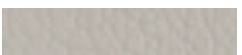

MARBIEL



NAUTILUS



NUANCE



PIRAMIDE

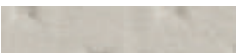

POLARIS



RACING



RALLY



SAFFIANO

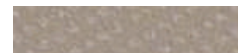

SANDSTONE



SHANTUNG

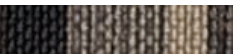

SKYLINE



TWISTER

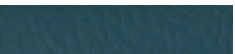

TANNERY

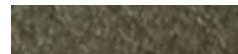

VALENCIA  
HERITAGE

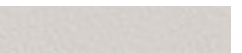

VELOURS

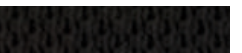

VENTURA



VOGUE



WALLTEX BI-ELASTIC



ZANDER



[spradling.eu/es](https://spradling.eu/es)  
consulta la web

## BAJO PEDIDO

Puedes pedirnos cualquier tela  
TARIFA Y CONDICIONES. CONSULTAR A FÁBRICA

# ACABADOS TELAS

MESINOR  
TABURETES&BARRAS

Finitions.Tissus

Para pedidos recomendamos utilizar los muestrarios físicos.  
Las fotos de acabados son una representación de los mismos.



**COLECCIONES**  
**MESINOR**

## aquaclean<sup>®</sup>

telas para vivir



BELLAGIO



TITAN

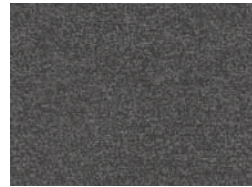

ALBA



DAYTONA

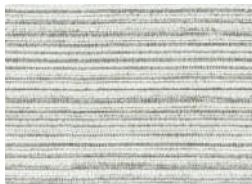

FONTANA



MARINA

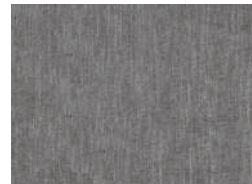

NAOMI

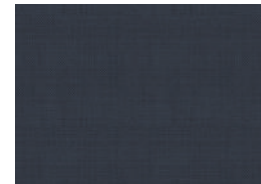

NATURA

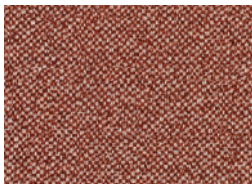

NURIEL



VENETO



[aquaclean.com](http://aquaclean.com)  
consulta la web

# BAJO PEDIDO

Puedes pedirnos cualquier tela  
TARIFA Y CONDICIONES. CONSULTAR A FÁBRICA

# ACABADOS TELAS

MESINOR  
TABURETES&BARRAS

Finitions.Tissus

Para pedidos recomendamos utilizar los muestrarios físicos.  
Las fotos de acabados son una representación de los mismos.



**COLECCIONES**  
**MESINOR**

**exit**  
**fabrics.** Upholstery  
for all needs

## SELECCIÓN MESINOR. BEST SELLERS



ROCA DE FANTASÍA

100%  
OUT-  
DOOR



SOLAR

100%  
OUT-  
DOOR



TOP OUT

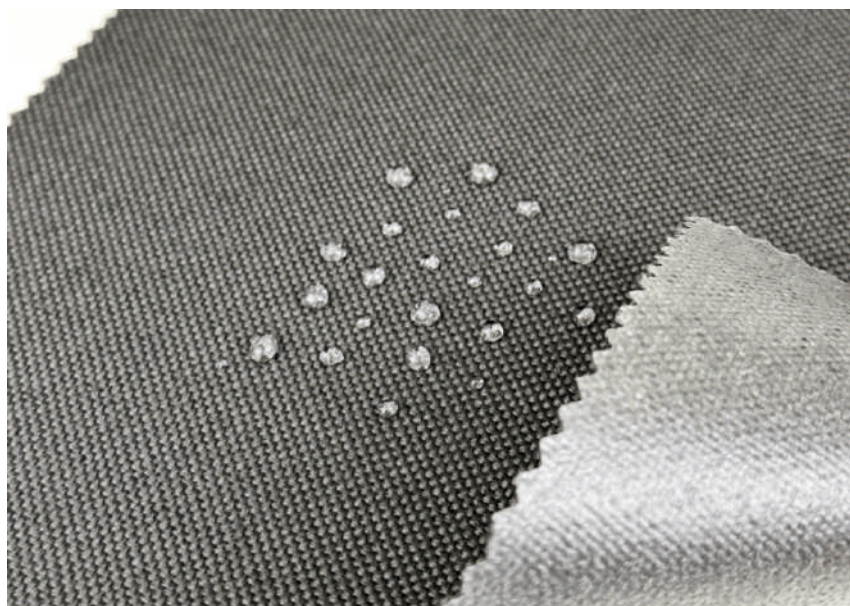

[exitfabrics.com](http://exitfabrics.com)  
consulta la web

**BAJO PEDIDO** Puedes pedirnos cualquier tela  
TARIFA Y CONDICIONES. CONSULTAR A FÁBRICA

# ACABADOS TELAS

MESINOR  
TABURETES&BARRAS

Finitions.Tissus

Para pedidos recomendamos utilizar los muestrarios físicos.  
Las fotos de acabados son una representación de los mismos.



## COLECCIONES MESINOR



# Vaya Tela!

## SELECCIÓN MESINOR. BEST SELLERS



BAMBU

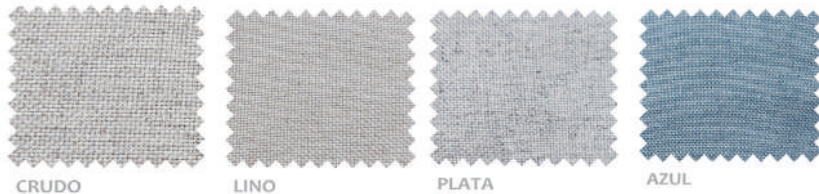

AMARAL



PDK



VEGAN



[cabanesortuno.com](http://cabanesortuno.com)  
consulta la web

# BAJO PEDIDO

Puedes pedirnos cualquier tela  
TARIFA Y CONDICIONES. CONSULTAR A FÁBRICA

# ACABADOS TELAS

MESINOR  
TABURETES&BARRAS

Finitions.Tissus

Para pedidos recomendamos utilizar los muestrarios físicos.  
Las fotos de acabados son una representación de los mismos.



## COLECCIONES MESINOR

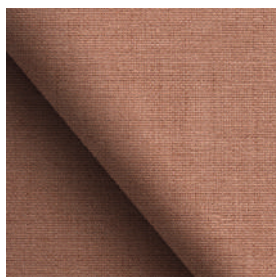

CLUB

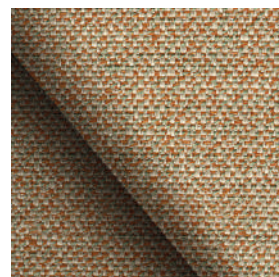

MOULIN



[creven.com](http://creven.com)  
consulta la web

## OTRAS COLECCIONES

Acrisol<sup>®</sup>  
(agora)<sup>®</sup>



## BAJO PEDIDO

Puedes pedirnos cualquier tela  
TARIFA Y CONDICIONES. CONSULTAR A FÁBRICA



Finitions. Plan de travail.

Para pedidos recomendamos utilizar los muestrarios físicos.  
Las fotos de acabados son una representación de los mismos.

## LAMINADO 19 mm

### CATEGORÍA 1



### CATEGORÍA 2



### CATEGORÍA 3 FENIX <sup>NTM</sup>



# ACABADOS LAMINADOS Encimeras



## BAJO PEDIDO

**MESINOR** Puedes pedirnos cualquier laminado  
TARIFA Y CONDICIONES. CONSULTAR A FÁBRICA

# ALVIC CENTER



**Synchron**<sup>®</sup>  
structured panel LINE  
by **ALVIC**

Tienes a tu disposición la SERIE SYNCRON LINE  
TARIFA Y CONDICIONES. CONSULTAR A FÁBRICA



**alvic.com**  
consulta la web



**Zénit** by **ALVIC**  
High Resistance Surface

Tienes a tu disposición la SERIE ZENIT B  
TARIFA Y CONDICIONES. CONSULTAR A FÁBRICA



**alvic.com**  
consulta la web

# ACABADOS LAMINADOS Encimeras



## BAJO PEDIDO

**MESINOR** Puedes pedirnos cualquier laminado  
TARIFA Y CONDICIONES. CONSULTAR A FÁBRICA



Tienes a tu disposición CIERTOS MODELOS DE STOCK.  
TARIFA Y CONDICIONES. CONSULTAR A FÁBRICA



**finsa.com**  
consulta la web



Tienes a tu disposición CIERTOS MODELOS DE STOCK.  
TARIFA Y CONDICIONES. CONSULTAR A FÁBRICA



**egger.com**  
consulta la web

# ACABADOS LAMINADOS Encimeras



## BAJO PEDIDO

**MESINOR** Puedes pedirnos cualquier laminado  
TARIFA Y CONDICIONES. CONSULTAR A FÁBRICA

**SONAE  
ARAUCO**

Taking wood further

### SELECCIÓN MESINOR. BEST SELLERS

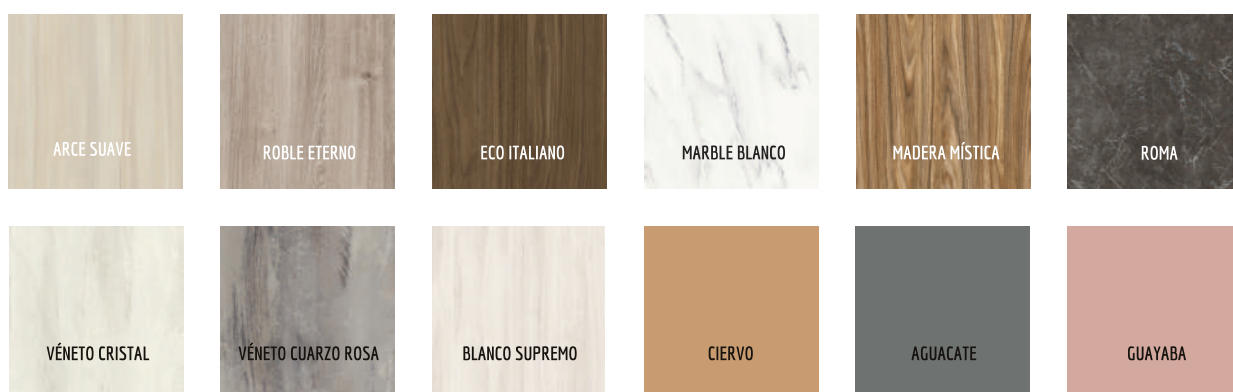

Tienes a tu disposición CIERTOS MODELOS DE STOCK.  
TARIFA Y CONDICIONES. CONSULTAR A FÁBRICA



### RESTO DE LA COLECCIÓN



[sonaearauco.com](http://sonaearauco.com)

consulta la web

Finitions.Coloris

Para pedidos recomendamos utilizar los muestrarios físicos.  
Las fotos de acabados son una representación de los mismos.



## PORCELÁNICO 3 mm + Cristal 5 mm

### CATEGORÍA 1 **TECHLAM®**

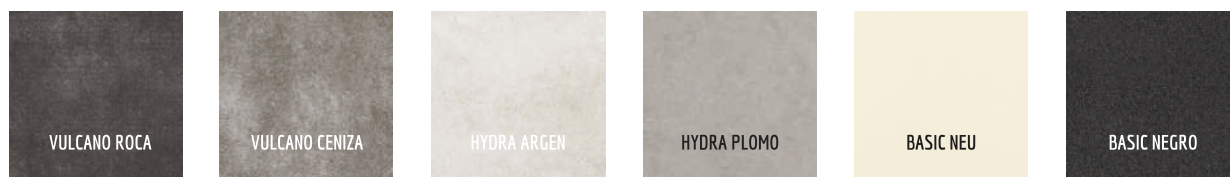

### CATEGORÍA 2 **TECHLAM®**



### CATEGORÍA 2 **NEOLITH**

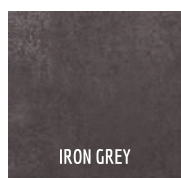

### CATEGORÍA 3 **LAMINAM** SUPERIOR NATURAL SURFACES



# ACABADOS PORCELÁNICOS. Encimeras

MESINOR  
TABURETES&BARRAS

Finitions.Coloris

Para pedidos recomendamos utilizar los muestrarios físicos.  
Las fotos de acabados son una representación de los mismos.



## LAMINAM 12 mm

### Grupo 0 y 1

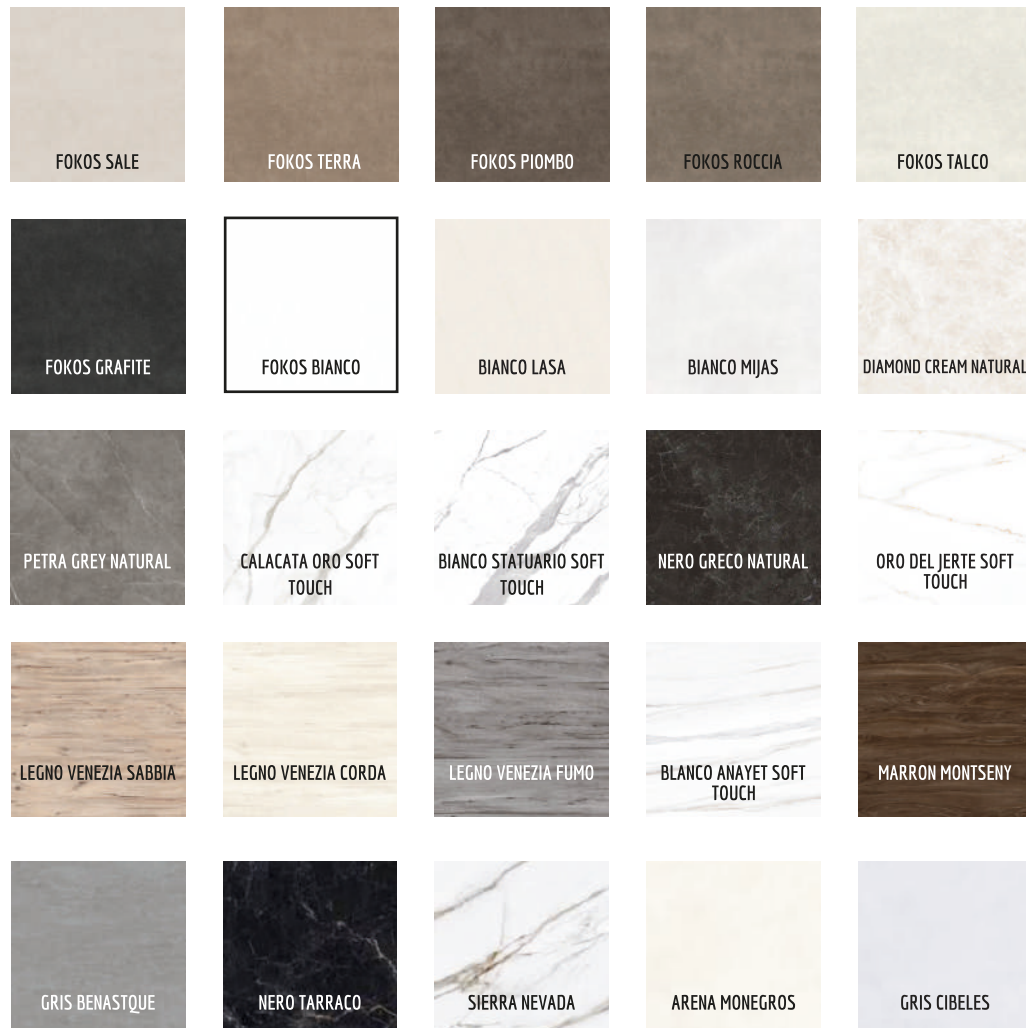

### Grupo 2



## RESTO DE LA COLECCIÓN



[laminam.com](http://laminam.com)

consulta la web

## Finitions.Coloris

Para pedidos recomendamos utilizar los muestrarios físicos.  
Las fotos de acabados son una representación de los mismos.



### ARKLAM 12 mm

#### SELECCIÓN MESINOR. BEST SELLERS

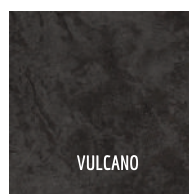
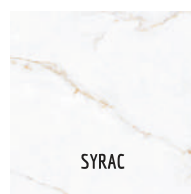
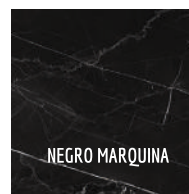
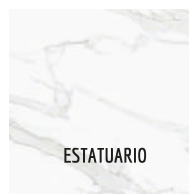

#### RESTO DE LA COLECCIÓN



[arklam.com](http://arklam.com)  
consulta la web

## Finitions.Coloris

Para pedidos recomendamos utilizar los muestrarios físicos.  
Las fotos de acabados son una representación de los mismos.



# COSENTINO®

## TODA LA COLECCIÓN

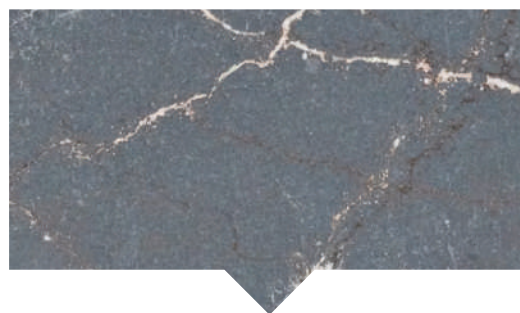

[cosentino.com](https://www.cosentino.com)  
consulta la web



[cosentino.com](https://www.cosentino.com)  
consulta la web





Finitions.Coloris

Para pedidos recomendamos utilizar los muestrarios físicos.  
Las fotos de acabados son una representación de los mismos.

## Patas y Armazones

### COLOR BÁSICO



### COLORES MUESTRARIO Y COLORES MADERA



### HAYA NATURAL

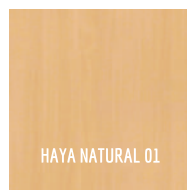

### ROBLE NATURAL

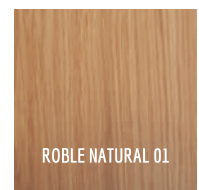

### HAYA BARNIZ

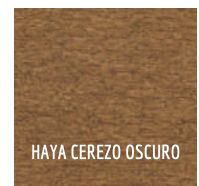
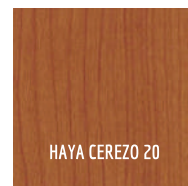

### ROBLE BARNIZ

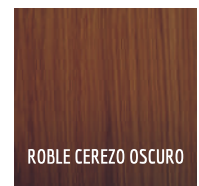
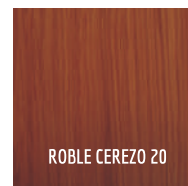
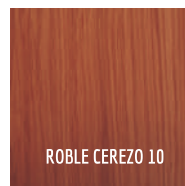
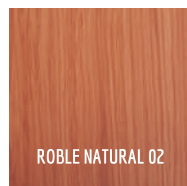

Finitions.Coloris

Para pedidos recomendamos utilizar los muestrarios físicos.  
Las fotos de acabados son una representación de los mismos.



## COLORES MUESTRARIO CRISTALES BRILLO, MATE Y ANTIRAYAS



# MESINOR.com

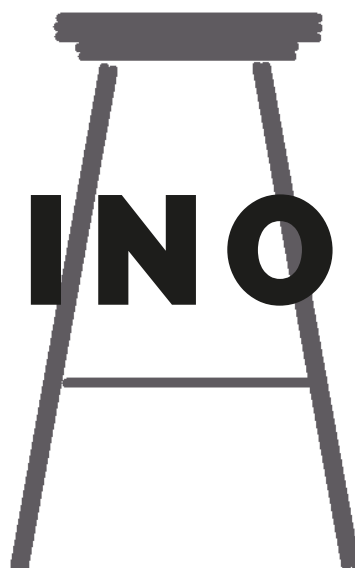

mesas y sillas

# GUÍA DE LIMPIEZA Y MANTENIMIENTO

## TELAS

tissus

### LIMPIEZA

El vinilo se debe limpiar periódicamente para mantener su apariencia y evitar la acumulación de contaminantes y mugre.

Toda mancha, derramamiento o suciedad se debe limpiar con rapidez para evitar un manchado permanente.

Use soluciones jabonosas suaves o productos de limpieza especiales para telas vinílicas para eliminar las manchas de la superficie del material. Limpie solamente con trapos humedecidos.

Las lacas, los limpiadores fuertes, los detergentes, los líquidos a base de xileno, la acetona y el MEK causan un daño inmediato y contribuyen al deterioro del material. El uso de estos limpiadores es bajo su responsabilidad.

Ciertas prendas de vestir y tintes de accesorios (como los utilizados en los vaqueros) pueden migrar a superficies más claras. Este fenómeno se ve incrementado por los efectos de la humedad y la temperatura, es irreversible.

### CARACTERÍSTICAS

Spradling, Valencia, Hitch, Silvertex

Antibacterial Protection

Antifungal Protection

Antimycotic Protection

PERMABLOK3R

Acabado Antimanchas

>300.000 ciclos de Martindale (EN ISO 12947:1999 Parte 2)

Rotura en frío a -23° C

Soporte y recubrimiento Antimoho

Resistencia a la radiación ultravioleta XENOTEST DIN 54004/NTC 1479

EN 71-3 (seguridad de los juguetes: Migración de ciertos elementos)

Resistente a las manchas por sulfuros

Acabado Antiestático

Dynactiv, Michigan, Winston, Abaka

Antifuego: EN 1021 (1-2)

Resistencia a la abrasión

Eficaz contra Hongos y Bacterias

Solidez del color a la luz artificial

Exento de Solvente

### NETTOYAGE

Le vinyle doit être nettoyé périodiquement pour conserver son apparence et éviter l'accumulation de polluants et de saleté.

Toutes les taches, déversements ou saletés doivent être nettoyés rapidement pour éviter une course permanent.

Utilisez des solutions savonneuses douces ou des produits de nettoyage spéciaux pour les tissus en vinyle pour éliminer les taches de la surface du matériau. Nettoyez uniquement avec des chiffons blancs humides.

Les laques, les nettoyeurs puissants, les détergents, les liquides à base de xylène, l'acétone et le MEK causent des dommages immédiats et contribuent à la détérioration du matériau.

L'utilisation de ces nettoyeurs est à vos propres risques.

Certains colorants pour vêtements et accessoires (tels que ceux utilisés dans les jeans) peuvent migrer vers des surfaces plus claires. Ce phénomène est accru par les effets de l'humidité et de la température; c'est irréversible.

### CARACTÉRISTIQUES

Spradling, Valencia, Hitch, Silvertex

Protection antibactérienne

Protection antifongique

Protection antimycosique

PERMABLOK3R

Fini résistant aux taches

>300.000 cycles Martindale (EN ISO 12947:1999 Partie 2)

Coupage à froid à -23° C

Support et revêtement anti-moisissure

Résistance aux rayons ultraviolets XENOTEST DIN 54004/NTC 1479

EN 71-3 (sécurité des jouets: Migration de certains éléments)

Résistant aux taches de soufre

Finition antistatique

Dynactiv, Michigan, Winston, Abaka

Ignifuge: EN 1021 (1-2)

Résistance à la abrasion

Efficace contre les champignons et les bactéries

Solidité des couleurs à la lumière artificielle

Sans Solvant

## piètement

## PATAS

Las patas y armazones metálicos no se deben forzar, ni arrastrar así como apoyar peso en exceso.

**NO RECOSTARSE FUERTEMENTE HACIA ATRÁS, PUEDE DAÑAR LA CARCASA.**

**No apoyar largo tiempo pesos en taburetes de tapicería ya que pueden dejar marcas de difícil eliminación en la tela.**

Las patas y armazones de madera, usar las mismas recomendaciones que las metálicas.

La limpieza debe realizarse con productos de limpieza suaves, no usar estropajos que puedan dañar la pintura/superficie. Secar para evitar oxidaciones y/o deformaciones originales por exceso de agua y/o humedad. Evitar productos químicos abrasivos, desengrasantes o disolventes.

Les pieds et les structures métalliques ne doivent pas être forcés, ne glissez pas et ne supportez pas l'excès de poids

**NE PAS SE PENCHER FORT, PEUT ENDOMMAGER LA SIÈGE.**

**Ne supportez pas de poids sur les tabourets rembourrés pendant de longues périodes car ils peuvent laisser des marques difficiles à enlever sur le tissu.**

Les pieds et les structures en bois utilisent les mêmes recommandations que les métalliques.

Le nettoyage doit être effectué avec des produits de nettoyage doux, n'utilisez pas de tampons à récurer qui peuvent endommager la peinture / la surface. Sécher pour éviter l'oxydation et / ou la déformation provoquée par un excès d'eau et / ou d'humidité. Évitez les produits chimiques agressifs, les dégraissants ou les solvants.

# CONDICIONES GENERALES

## 1. CONDICIONES VENTA

- La tarifa está expresada en puntos.
- Portes pagados a partir de pedidos superiores a 200 euros (después de aplicar el descuento comercial), en Península. El resto consultar a fábrica.
- Se aplicará el IVA correspondiente en cada caso, según la legislación vigente.
- Los pedidos deben ser enviados por escrito, utilizando el formato de pedido, a nuestra cuenta de correo electrónico: [pedidos@mesinor.com](mailto:pedidos@mesinor.com).
- Características técnicas: Consultar ficha.
- MESINOR se reserva el derecho de modificar el diseño, medidas, colores, precios, tarifas, etc. de cualquier de sus productos, sin previo aviso.
- Puede surgir pequeñas diferencias en el color de los acabados de maderas, metales y tapizados dado que resulta técnicamente imposible garantizar un tinte constante en el tiempo.
- La entrega se realizará en tienda.

## 2. GARANTÍA Y SAC

- La garantía del producto es de 3 años y no cubre los daños ocasionados por un uso o mantenimiento impropio o inadecuado, ni tampoco por el desgaste del uso cotidiano.
- SAC. Mesinor dispone de un departamento de Atención al cliente al cual puede dirigirse mediante el correo [info@mesinor.com](mailto:info@mesinor.com)

## 3. SEGURO Y TRANSPORTE DE MERCANCÍA

Nuestros envíos de mercancías van asegurados para cubrir posibles desperfectos ocasionados por el transporte:

- Es necesario revisar la mercancía (contar los bultos y observar si el embalaje está golpeado) y anotar en la hoja de recepción cualquier incidencia que se observe (en este caso se solicitará fotos de la incidencia)
- Hay un plazo de 24 horas desde la recepción de la mercancía para notificar cualquier incidencia. Pasado el cual, el seguro de transporte no se hace cargo de los desperfectos o pérdidas.

## 4. DEVOLUCIONES

- Los portes de envío y devolución correrán por cuenta del cliente.
- Se abonará el 75% del valor de la mercancía.
- Las mesas no se cambian en ningún caso.

- La devolución o cambio de sillas (que tengamos en nuestro almacén) por razones no imputables a MESINOR, supondrá un cargo de un 25% en concepto de manipulación y será previo consentimiento por escrito por parte de fábrica y el material ha de ser devuelto con las mismas condiciones de estado y embalaje con las que fue enviado.
- **NO CABE RECLAMACIÓN POR TRANSPORTE en los casos:**
  - Si se firma la hoja de recepción sin la anotación de la incidencia en la misma.
  - Si en la hoja de recepción se indica NO VÁLIDO o PENDIENTE DE REVISIÓN.



## 5. CONDICIONES DE PAGO

- Nuestra única forma de pago es recibo bancario a 30 días, sujeto a la clasificación de riesgo. No se admiten en ningún caso: pagarés, confirming, recibos al representante u otra forma de pago.
- En caso de efectos devueltos, estos deberán ser abonados sumándoles los gastos bancarios correspondientes, no se enviará ninguna mercancía hasta que el impago resulte cobrado.
- MESINOR no aceptará en ningún caso, modificaciones, alteraciones o retrasos en vencimientos motivados por periodos vacacionales u otros.

## 6. CONDICIONES LEGALES

MESINOR no se hace responsable de cualquier error tipográfico existente en este catálogo así como se reserva el derecho de introducir cualquier modificación técnica o de diseño necesaria.

MESINOR no autoriza la publicación de sus productos por Internet sin consultar a fábrica.

Todas las imágenes de este catálogo no son contractuales con el producto original. Puede haber variaciones.

# CONDITIONS GENERALES

## 1. CONDITIONS DE VENTE

- Les commandes doivent être envoyées par écrit, avec le format commande, par mail: [internacional@mesinor.com](mailto:internacional@mesinor.com).
- Caractéristiques techniques: voir la fiche de chaque modèle.
- MESINOR se réserve la droit de modifier le design, les mesures, les couleurs, les prix, les tarifs, etc. de l'un de ses produits, sans préavis.
- Comme spécifié dans échantillons, il peut y avoir de petites différences dans la couleur des finitions en bois, métal e tissu car il est techniquement impossible de garantir une teinture constante dans le temps.
- Possibilité de fabrication sur mesure. Seulement dans les modèles indiqués. Taux en tant que supérieur immédiat.

## 2. GARANTIE ET SERVICE CLIENT

- La garantie du produit est de 3 ans et ne couvre pas les dommages causés par une utilisation ou un entretien inapproprié ou inadéquat, ni par l'usure due à une utilisation quotidienne.
- SAV. Mesinor dispose d'un service client auquel vous pouvez contacter par email [internacional@mesinor.com](mailto:internacional@mesinor.com)

## 3. ASSURANCE ET TRANSPORT DE MARCHANDISES

Nos envois de marchandises sont assurés pour couvrir les éventuels dommages causés par le transport:

- Lorsque vous recevez un envoi, examinez-le attentivement.
- Vous avez 24 heures pour faire une réclamation auprès de MESINOR. Après cette période, nous ne pourrions plus traiter ces réclamations sans frais.

Toutes réclamations pour bris ou dommages doivent être accompagnées de photographies du matériel endommagé.

## 4. RETOURS

- Tout retour de marchandises doit obligatoirement faire l'objet d'un accord préalable par MESINOR:
- En cas d'erreur de commande d'un client, ce dernier s'engage à nous retourner la marchandise par son propre transporteur et à ses frais.
- Les frais d'expédition et de retour seront à la charge du client et nous seront adressés en franco de port et obligatoirement dans son emballage d'origine.

- Si le retour est accepté, pour des raisons non imputables à Mesinor, 15 % de la marchandise sera facturée en raison des frais de manutention et d'expédition.
- En cas de retour, le client doit joindre. Une copie du bon de livraison et ou de la facture.
- Si les marchandises arrivent dans un état imparfait en permettant pas de bonnes conditions d'utilisation et de reventes, elles ne seront pas remboursées.
- Pour les commandes dites spécifiques et sur mesures: tissus d'ameublement, finitions spéciales ou articles fabriqués, préparés ou finis "sur demande", coloris spéciaux sur mesure ou personnalisés..., aucun retour ne sera accepté.
- En cas d'effets retournés, ceux-ci doivent être payés en ajoutant les frais bancaires correspondants, aucune marchandise ne sera envoyée tant que le défaut ne sera pas facturé.



## 5. CONDITIONS DE PAIEMENT

- Mode de paiement: prélèvement automatique 30 jours à compter de la date de facturation.
- MESINOR n'acceptera en aucun cas les modifications, altérations ou retards dans les échéances dues à des vacances ou à d'autres périodes.

## 6. CONDITIONS JURIDIQUES

MESINOR n'est pas responsable des erreurs typographiques existant dans ce catalogue et se réserve le droit d'apporter les modifications techniques ou de conceptions nécessaires.

MESINOR n'autorise pas la publication de ses produits en ligne consulter l'usine.

Toutes les images de ce catalogue ne sont pas contractuelles avec le produit d'origine. Il peut y avoir des variations de finitions et de couleurs.





ESTOS DATOS SON NECESARIOS PARA SER TU SASTRE A MEDIDA  
(Haz correctamente tu PEDIDO)

**MESINOR**  
B-26521849

FABRICANTE DE  
MESAS Y SILLAS

pedidos@mesinor.com  
941 34 00 43 opción 2

## FORMATO PEDIDO

<b>CLIENTE</b>	<b>OBSERVACIONES:</b>	
<b>FECHA</b>		
<b>REFERENCIA</b>		
<b>MESA</b>		

Cantidad	MODELO	MEDIDAS					ENCIMERA					
		A LARGO	B ANCHO	E ALT. MESA	H ALT. INTERIOR	J ENCIMERA	RECTO	CHAFLÁN	VOLADA			
<b>CANTO</b>	<b>EXTENSIÓN</b>	<b>ARMAZÓN</b>					<b>PATAS</b>					
<b>FRENTE CAJÓN:</b>	<b>CAJÓN:</b>	<b>CUBERTERO:</b>										

### SILLA/TABURETE

Uds.	Modelo	TELA Asiento	Tipo Carcasa	TELA Carcasa D: delantera T: trasera	Relleno	Armazón/patas
				D: T: D: T: D: T: D: T:		
				D: T: D: T: D: T: D: T:		
				D: T: D: T: D: T: D: T:		
				D: T: D: T: D: T: D: T:		
				D: T: D: T: D: T: D: T:		
				D: T: D: T: D: T: D: T:		

### Leyenda

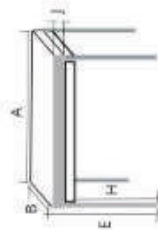

NOTA IMPORTANTE: SI NO SE INDICA EN EL PEDIDO POR NORMA LOS EXTENSIBLES Y EL CANTO SE FABRICARÁN EN EL MISMO COLOR QUE EL ARMAZÓN

**IMPORTANTE: LOS PEDIDOS NO CUMPLIMENTADOS CORRECTAMENTE PUEDEN DERIVAR EN UN PLAZO DE ENTREGA MAYOR**



## **AGRADECIMIENTOS**

Este catálogo no podría haber sido posible sin la colaboración de varias empresas del entorno que amablemente nos han permitido escenificar nuestro producto en sus instalaciones.

¡Muchas gracias!

ALVIC CENTER LOGROÑO  
ULTRA CONGELADOS DEL OJA  
BODEGAS DAVID MORENO  
CAMPING DE BAÑARES  
GÓMEZ MOBILIARIO DE COCINA  
BODEGAS VILLARICA  
JUBA PERSONAL PROTECTIVE EQUIPMENT  
GRÁFICAS OCHOA

Y tampoco, sin nuestro gran fotógrafo EDUARDO, que forma ya parte del EQUIPO MESINOR. ¡Mil gracias!

HUETO FOTÓGRAFOS