



PRODUCT



DESCRIPTION

- Opening angle: 110°
- Depth of hinge cup: 11.5mm
- Diameter of hinge cup: 35mm
- Range of door thickness: 16-26mm
- Possible drilling distances on the door(K): 3-6 mm

APPLICATION

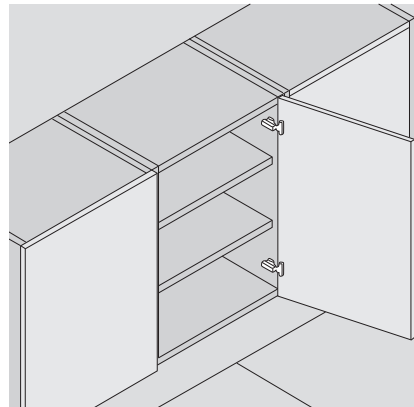

ORDER INFORMATION



Φ 35mm Options of screws and dowels:

M10 dowel Dowel No: M	Expandable dowel Dowel No: K
M8 dowel Dowel No: N	Expandable dowel Dowel No: K0
Euro screw Dowel No: B	Quick dowel Dowel No: T0

PLANNING

Space needed to open the door

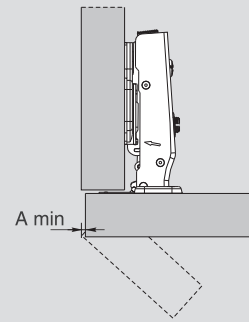

	T=	16	17	18	19	20	21	22	23	24	25	26
K=3	A=	0.7	0.9	1.2	1.5	1.8	2.2	2.6	3.2	3.8	4.5	5.3
K=4	A=	0.7	0.9	1.1	1.4	1.8	2.1	2.5	3.0	3.5	4.4	4.9
K=5	A=	0.6	0.9	1.1	1.4	1.7	2.0	2.4	2.9	3.4	3.9	4.6
K=6	A=	0.6	0.8	1.1	1.3	1.6	2.0	2.4	2.8	3.2	3.8	4.4

Φ 35mm Hinge cup types

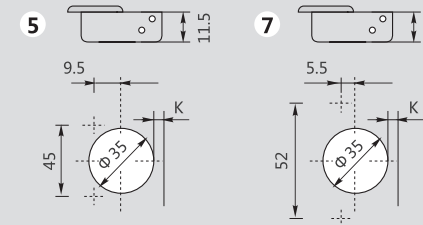

Use these formulas to determine the type of hinge arm, the drilling distance "K" and the height of the mounting plate "H" for each door application.

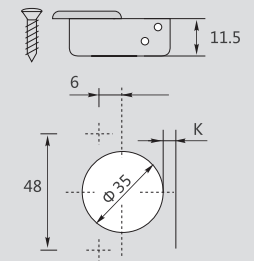

Nickel plated(A01) Specially treated(A11)

Space needed to open the door

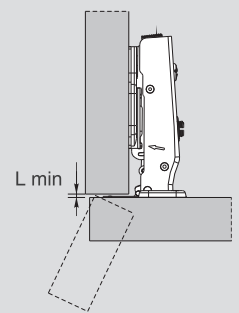

	T=	16	17	18	19	20	21	22	23	24	25	26
K=3	L=	0.0	0.0	0.0	0.0	0.0	0.0	0.0	0.0	0.0	0.0	0.1
K=4	L=	0.0	0.0	0.0	0.0	0.0	0.0	0.2	0.4	0.7	0.9	1.1
K=5	L=	0.0	0.2	0.4	0.6	0.8	1.0	1.2	1.4	1.6	1.8	2.0
K=6	L=	0.9	1.2	1.4	1.6	1.8	2.0	2.2	2.4	2.6	2.8	3.0

- The above values are calculated on the assumption that the doors have square edges.
- They are reduced if the doors have radiused edges.

Projection of the door

Projection of the door from the cabinet side at the max. opening. The figures are based on a straight arm hinge, H=0mm mounting plate and drilling distance (K) =3mm.

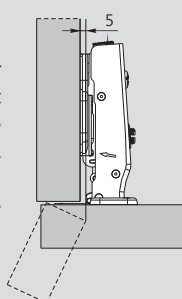

"C" value

$$C=20+K+A$$

With this formula you can obtain the max. thickness of the moulded door that can be opened without touching adjacent carcass sides, doors or walls, whilst bearing in mind the above L-K-T values.

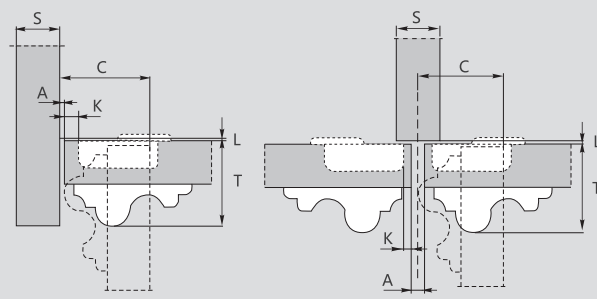

C80 series snap-on soft close hinge 110° (two way, cam-adjustable)

Full overlay C=0



H=14+K-(D)

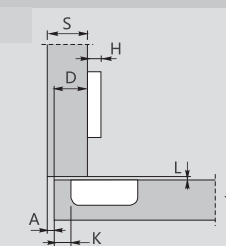

	Item No.	Pcs/ctn
Soft-close	C80A676F	200
Sprung	C80A676	200

Half overlay C=9



H=5+K-(D)

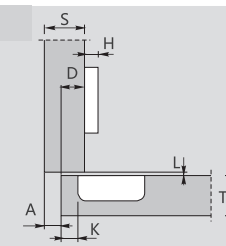

	Item No.	Pcs/ctn
Soft-close	C80B676F	200
Sprung	C80B676	200

Inset C=18



H=-6+K+(A)

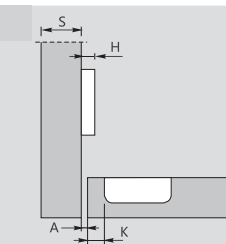

	Item No.	Pcs/ctn
Soft-close	C80C676F	200
Sprung	C80C676	200